

ADVANCE COPY FOR USE IN  
ORDNANCE OFFICE ONLY.  
REGULAR DISTRIBUTION WILL  
BE MADE BY YOUR LOCAL  
ADJUTANT GENERAL OR  
POST ADJUTANT.

TM 9-731G

DECLASSIFIED  
DATE 03-01-78 BY 785097  
BY NAME 0303 23-5-78

WAR DEPARTMENT

TECHNICAL MANUAL

3-INCH GUN  
MOTOR CARRIAGE M10A1

28 JULY 1943

FOR ORDNANCE OFFICE USE ONLY

★ Dissemination of restricted matter.—The information contained in restricted documents and the essential characteristics of restricted materiel may be given to any person known to be in the service of the United States and to persons of undoubted loyalty and discretion who are cooperating in Government work, but will not be communicated to the public or to the press except by authorized military public relations agencies. (See also paragraph 18 b, AR 380-5, 28 September 1942.)

U.S. ARMY MILITARY HISTORY INSTITUTE  
CARLISLE BARRACKS, PA 17013-5008

REGRADED UNCLASSIFIED BY  
AUTHORITY OF DOD DIR. 5200.1 R  
BY RAK/US ON 112304

TM 9-731G 3-INCH GUN MOTOR CARRIAGE M10A1

# 3-INCH GUN MOTOR CARRIAGE M10A1

Prepared under the direction of the  
**Chief of Ordnance**  
 (with the cooperation of the Ford Motor Company)

## CONTENTS

### PART ONE—OPERATING INSTRUCTIONS

SECTION		Paragraphs	Pages
	I. Introduction . . . . .	1- 2	4
	II. Description and tabulated data . . . . .	3- 4	5-11
	III. Operation and controls . . . . .	5- 11	12-28
	IV. Operation under unusual conditions . . . . .	12- 17	29-30
	V. Preventive maintenance inspections and service . . . . .	18- 22	31-39
	VI. Lubrication . . . . .	23- 24	40-46
	VII. Equipment and tools on vehicle . . . . .	25- 30	47-53

### PART TWO—VEHICLE MAINTENANCE INSTRUCTIONS

SECTION	VIII. Maintenance allocation . . . . .	31- 32	54-62
	IX. Organization preventive maintenance services . . . . .	33	63-77
	X. Organizational tools and equipment . . . . .	34	78-81
	XI. Engine . . . . .	35- 44	82-103
	XII. Ignition system . . . . .	45- 50	104-112
	XIII. Fuel system . . . . .	51- 60	113-123
	XIV. Cooling system . . . . .	61- 69	124-131
	XV. Electrical system and equipment . . . . .	70-110	132-159
	XVI. Nonelectrical instruments . . . . .	111-114	160-162
	XVII. Clutch, propeller shaft, and universal joints . . . . .	115-117	163-172

★ *Dissemination of restricted matter.*—The information contained in restricted documents and the essential characteristics of restricted materiel may be given to any person known to be in the service of the United States and to persons of undoubted loyalty and discretion who are cooperating in Government work, but will not be communicated to the public or to the press except by authorized military public relations agencies. (See also paragraph 18 b, AR 380-5, 28 September 1942.)

**3-INCH GUN MOTOR CARRIAGE M10A1**

	Paragraphs	Pages
<b>SECTION XVIII. Power train (transmission, differential, and final drive) . . . . .</b>	<b>118-124</b>	<b>173-187</b>
<b>XIX. Suspension and tracks . . . . .</b>	<b>125-131</b>	<b>188-203</b>
<b>XX. Hull and turret . . . . .</b>	<b>132-135</b>	<b>204-205</b>
<b>XXI. Fire extinguisher system . . . . .</b>	<b>136-139</b>	<b>206-208</b>
 <b>PART THREE—ARMAMENT</b> 		
<b>SECTION XXII. Introduction . . . . .</b>	<b>140-142</b>	<b>209-213</b>
<b>XXIII. Description and functioning of gun . . . . .</b>	<b>143-148</b>	<b>214-236</b>
<b>XXIV. Description and functioning of mount . . . . .</b>	<b>149-156</b>	<b>237-248</b>
<b>XXV. Operation of gun . . . . .</b>	<b>157-163</b>	<b>249-255</b>
<b>XXVI. Lubrication of gun and mount . . . . .</b>	<b>164-168</b>	<b>256-258</b>
<b>XXVII. Sighting equipment . . . . .</b>	<b>169-172</b>	<b>259-262</b>
<b>XXVIII. Ammunition . . . . .</b>	<b>173-176</b>	<b>263-271</b>
<b>REFERENCES . . . . .</b>		<b>272-274</b>
<b>INDEX . . . . .</b>		<b>275-283</b>

3-INCH GUN MOTOR CARRIAGE M10A1



RA PD 28058

Figure 1—3-Inch Gun Motor Carriage M10A1—Three-quarter Front View

3-INCH GUN MOTOR CARRIAGE M10A1

PART ONE

OPERATING INSTRUCTIONS

Section I

INTRODUCTION

	Paragraph
Scope .....	1
Records .....	2

1. SCOPE.

a. This manual is published for the information and guidance of the personnel of the using arms charged with the operation and maintenance of this materiel.

b. The manual contains descriptions of the major units and their function as well as instructions for operation, inspection, minor repairs, and unit replacement. Sections I through VII contain information chiefly for the guidance of operating personnel. Sections VIII through XXI contain information intended chiefly for the guidance of personnel of the using arms doing maintenance work. Sections XXII through XXVIII contain information on armament for the operating personnel and using arms.

c. If repairs, modifications, or adjustments are beyond the scope of the using arm personnel, do not attempt them. Notify responsible ordnance service in order that trained personnel and suitable equipment may be provided, or proper instructions issued.

2. RECORDS.

a. An accurate record must be kept of each motor vehicle issued by the Ordnance Department. For this purpose, the Motor Book for Ordnance Vehicles (O.O. Form 7255), generally called "Log Book," is issued with each vehicle and must accompany it at all times. This book furnishes a complete record of the vehicle, from which valuable information concerning operation and maintenance costs, etc., is obtained, and organization commanders must insist that correct entries are made. This book will habitually be kept in a canvas cover to prevent its being injured or soiled. The page bearing a record of assignment must be destroyed prior to entering the combat zone. All other references which may be posted regarding the identity of the organization must be deleted.

Section II

DESCRIPTION AND TABULATED DATA

	Paragraph
Description of vehicle .....	3
Tabulated data .....	4

3. DESCRIPTION OF VEHICLE.

a. **General.** The 3-inch Gun Motor Carriage M10A1 is an armored, full track laying vehicle, powered by a 500-horsepower Ford tank engine which is an 8-cylinder, liquid-cooled, V-type engine designed specifically for tanks. The engine is located in the rear of the hull. The chief armament consists of a 3-inch Gun M7, in an open top turret of welded armor plate, which is mounted on the all-welded hull or armor plate. A cal. .50 anti-aircraft machine gun is mounted at the rear of the turret opening. A consistent use of sloping surfaces on both hull and turret greatly reduces the vulnerability of the vehicle to damage by gunfire. The turret has no revolving turret platform (basket) such as is used in tanks.

b. **Controls.** The vehicle is steered by means of levers, which operate steering brakes in the 1-piece differential housing. Braking is effected by pulling back both steering brake levers at the same time. Two types of parking brakes have been used. In the original design, the parking brake operates on a drum on the transmission output shaft (fig. 7). In the later design, a means of locking the steering brakes (fig. 8) is provided which permits their use as parking brakes. The synchromesh transmission has five forward speeds and one reverse.

c. **Communication.** The vehicle is equipped with a 2-way radio for outside communication, and with an intravehicle telephone system (interphone) serving all of the crew with the exception of the loader.

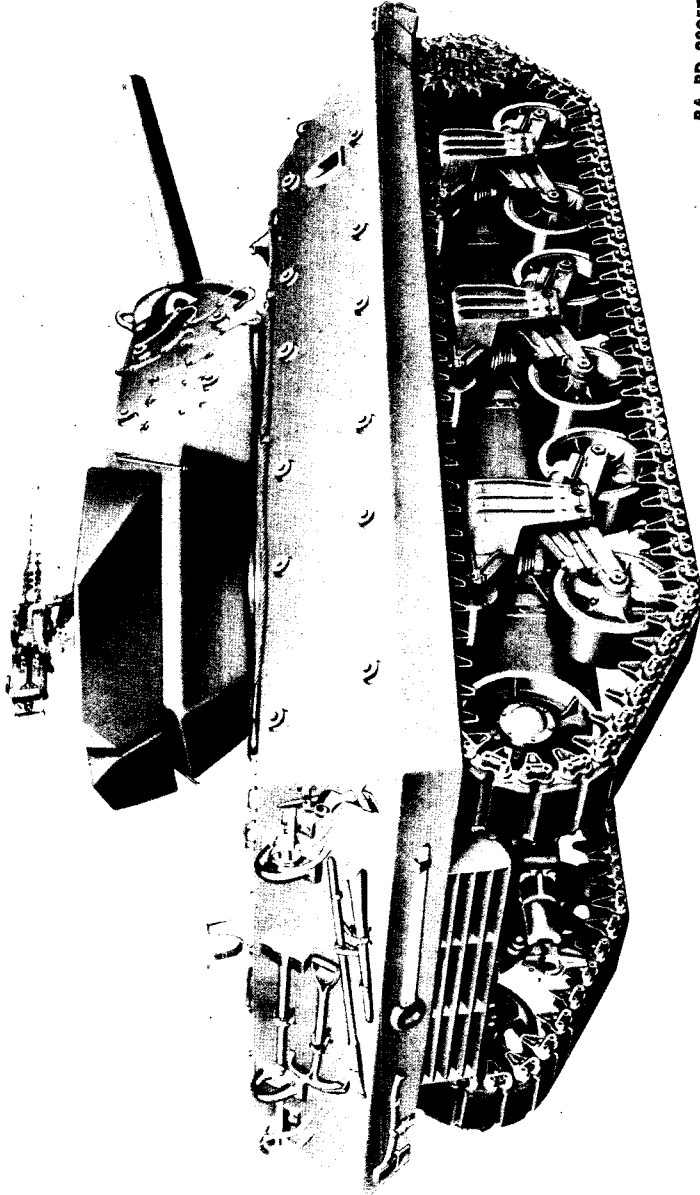
d. **Trailer for Ammunition.** A special pintle hook at the rear of the vehicle (fig. 2) provides for attaching a 2-wheel ammunition cart carrying munitions to supplement the supply stowed within the vehicle.

4. TABULATED DATA.

a. **General.**

Weight without armament, auxiliary armor, water, fuel, and crew .....	54,000 lb
Ground pressure, per sq in. ....	13 1/2 lb
Width, over-all .....	10 ft
Length, over-all .....	19 ft 7 1/8 in.
Height, over-all .....	8 ft 1 5/16 in.
Ground clearance (under final drive housing) .....	17 3/8 in.
Tread (center to center of tracks) .....	83 in.

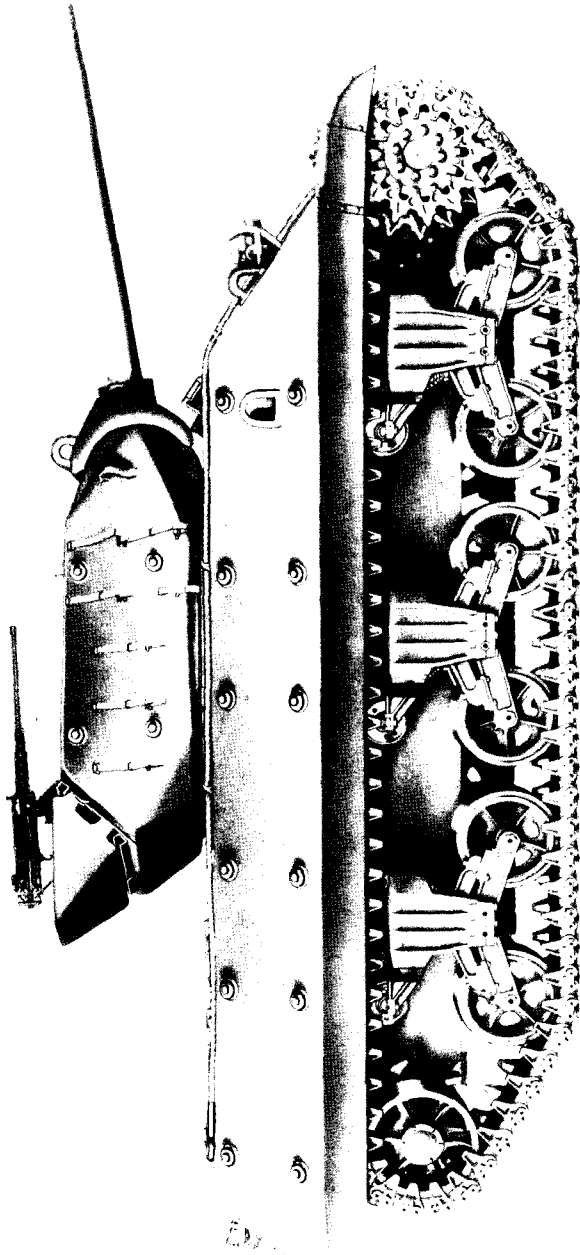
3-INCH GUN MOTOR CARRIAGE M10A1



RA PD 28057

Figure 2—3-Inch Gun Motor Carriage M10A1—Three-quarter Rear View

DESCRIPTION AND TABULATED DATA



RA PD 27542

Figure 3—3-Inch Gun Motor Carriage M10A1—Right Side View



**3-INCH GUN MOTOR CARRIAGE M10A1**

**b. Engine.**

Ford tank engine	Model GAA
Rated horsepower	500 at 2,600 rpm
Number of cylinders (60-deg V)	8
Weight of engine, with accessories	1,740 lb
Engine cruising speed	2,600 rpm
Engine maximum speed for short periods	2,800 rpm

**c. Communication.**

Radio	SCR 610, sending and receiving
Intravehicle	Telephone
Flags, signal	1 set
Light, recognition	1

**d. Seats.** Adjustable, padded, chair-type seats, equipped with safety belts, are provided for driver and assistant driver. Round, padded seats of the snap down type, are provided for the loader and vehicle commander.

**e. Armor Thickness.**

**Hull:**

Front bow plate	1½ in.
Lower side plate	1 in.
Upper side plates	¾ in.
Top plate	¾ in.
Rear cover plate	¾ in.
Bottom plate (floor)	½ in.
Deflector (above track)	¼ in.

**Turret:**

Gun shield (cast)	2¾ in.
Sides (plate)	1 in.
Trunnion support (plate)	2½ in.

**f. Turret.**

Armor plate, 360-degree manual traverse.

<b>g. Crew</b>	5 men
----------------	-------

**h. Tracks (Rubber Block or All Steel).**

Track shoe width (tread)	12½ <sub>16</sub> in.
Track pitch	6 in.
Ground contact	3,346 sq in.
Blocks per track	79 in.

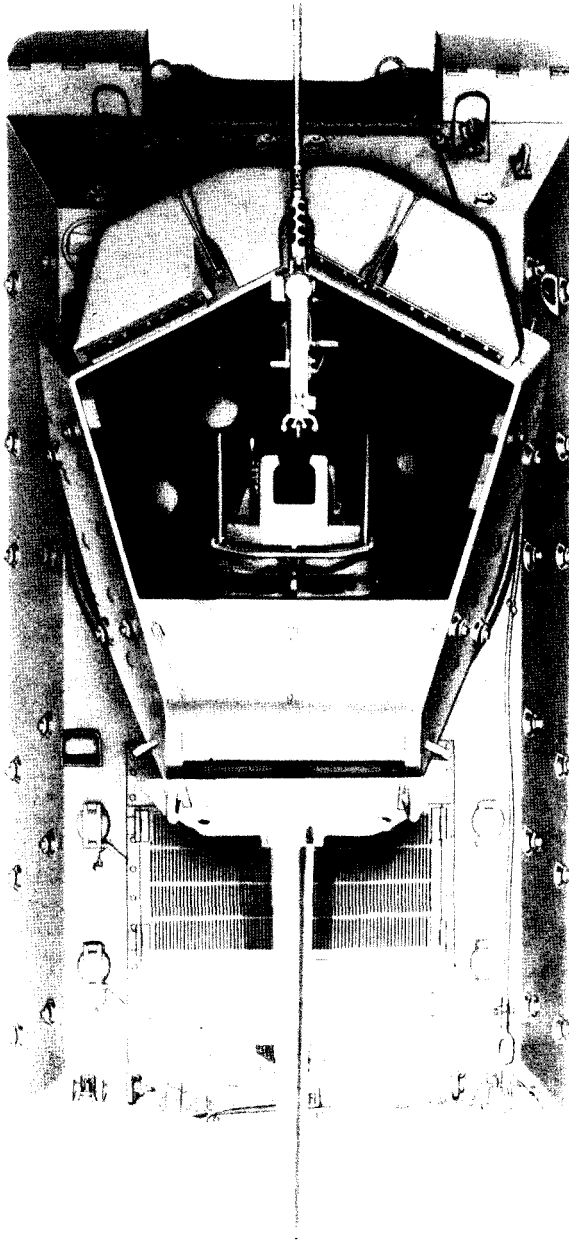
**i. Fuel.**

Number of miles without refueling:

Cross country	110 miles
Highway	155 miles
Octane rating of fuel	80 or higher

**j. Lubrication (sec. VI).**

DESCRIPTION AND TABULATED DATA



RA PD 27541

Figure 4—3-Inch Gun Motor Carriage M10A1—Top View

3-INCH GUN MOTOR CARRIAGE M10A1

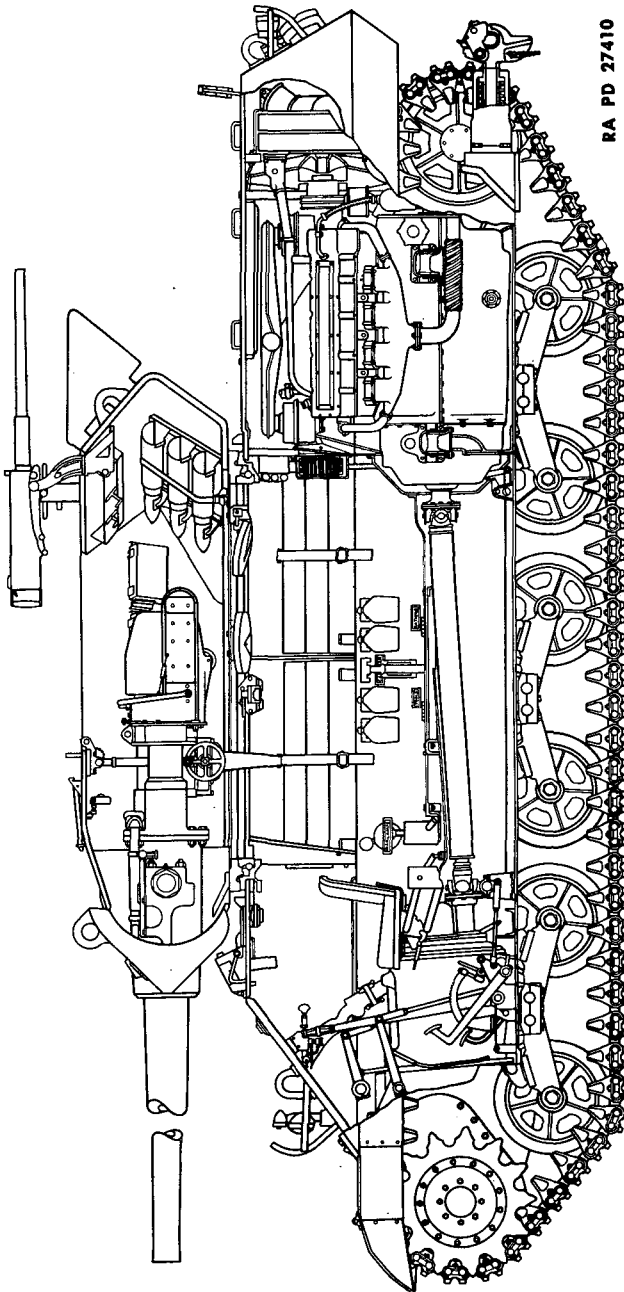


Figure 5—3-Inch Gun Motor Carriage M10A1—Longitudinal Section

**DESCRIPTION AND TABULATED DATA**

**k. Performance.**

Maximum speeds for various gears:

Maximum speed, 1st gear	2 mph
Maximum speed, 2nd gear	6 mph
Maximum speed, 3rd gear	10 mph
Maximum speed, 4th gear	16 mph
Maximum speed, 5th or high gear	26 mph
Maximum speed, reverse	3 mph

**l. Limitations of the Vehicle.**

Maximum recommended sustained speed (on hard road)	26 mph
Maximum speed for short periods	28 mph
Maximum allowable engine speed	2,800 rpm
Minimum engine idling speed	500 rpm
Maximum grade ascending ability	50 percent
Maximum grade descending ability	50 percent
Maximum width of ditch vehicle will cross	7 ft 5 in.
Maximum vertical obstacle, such as a wall, that vehicle with rubber tracks without grousers will climb over	18 in.
Maximum fording depth (at slowest speed)	36 in.

**m. Fuel and Oil Capacities.**

Engine oil pan	32 qt
Power train (transmission differential and final drive)	152 qt
Cooling system	17 gal
Fuel tanks (total)	192 gal
Right rear tank	39½ gal
Left rear tank	39½ gal
Right front tank	58 gal
Left front tank	55 gal

## 3-INCH GUN MOTOR CARRIAGE M10A1

## Section III

## OPERATION AND CONTROLS

	Paragraph
General information on instruments and controls . . . . .	5
Prestarting inspection . . . . .	6
Starting instructions . . . . .	7
Engine test . . . . .	8
Stopping the engine . . . . .	9
Operating the vehicle . . . . .	10
Towing instructions . . . . .	11

## 5. GENERAL INFORMATION ON INSTRUMENTS AND CONTROLS.

### a. Instrument Panel (fig. 6).

(1) **GENERAL.** The instrument panel is located on the left sponson to the left of the driver as shown in figure 6, and includes the following instruments and devices:

(a) *Circuit Breakers.* Seven circuit breaker buttons are provided in the upper left-hand corner of the instrument panel. These buttons are pressed to reclose the circuit breakers which take the place of the conventional fuses. In each instance when these circuits are overloaded, the circuit breaker will open. There is little reason for the operator of the vehicle to remember which button controls a specific circuit, since it requires only a fraction of a second to press all seven.

(b) *Fuel Cut-off Switch Button.* To the left of the ignition switch a push button switch is provided which operates the carburetor degasser units electrically. When stopping the engine, always push the button in and hold in this position until the engine stops. This shuts off the fuel from the idle fuel supply wells in the carburetors and starves the engine. This must be done before turning the engine off.

(c) *Utility Outlets.* Two utility outlets that permit plugging in trouble lights, etc., are provided at the top of the instrument panel.

(d) *Ammeter.* To the right of the clock, an ammeter is provided with a range of a 100-ampere discharge to a 100-ampere charge. If, during normal operation, when little current is being used, the ammeter consistently indicates discharge, either the generator regulator is not functioning properly or the generator itself is at fault (par. 71 d). In either case the battery is not being charged. These units should receive immediate attention to prevent failure during operation. If the ammeter indicates more than a 100-ampere charge, the current limiting unit in one or both of the generator regulators probably is at fault. Notify ordnance maintenance personnel to avoid burning out the generator.

## OPERATION AND CONTROLS

(e) *Ignition Switch.* The engine uses two 4-cylinder "Bosch" magnetos which are controlled by a 4-position switch in the center of the instrument panel at the top. When the switch lever is all the way to the left, both magnetos are on. When the switch lever is at the position marked "L," the left-hand magneto only is on, and the engine will run on the left-hand four cylinders only (left or right is as viewed from the rear of the vehicle when facing the same direction as the vehicle is headed). When the ignition switch lever is at the position marked "R," the right-hand magneto is on and the engine will run on the right-hand four cylinders only.

(f) *Voltmeter.* To the right of the ammeter, a voltmeter having a range from 16 to 32 volts is provided. When the battery master switch is off, the voltmeter will read at the lower end of the scale. When the master switch is on, the voltmeter should read battery voltage (approximately 24 volts). If the reading is low with the engine not running and no electrical energy is being used, the batteries are low in charge and should be recharged. At normal operating speeds during normal ambient temperatures, the voltage should not exceed 30 volts. If the reading is greater than this, the generator regulator probably is not properly limiting the voltage. Notify ordnance maintenance personnel to avoid burning out the generator.

(g) *Blackout Driving Light Switch.* The blackout driving light may be used to supply illumination for driving when the service driving lights might reveal the position of the vehicle. First, remove both service head lamps from their sockets at the front of the vehicle; then insert the blackout driving lamps in the lamp sockets. *These lamps when not in use are carried behind the driver and assistant driver's seats.* With the switch marked "LIGHTS" pulled out to first position, pull out on blackout drive light switch button, to turn on driving light. The blackout head lamp, marker lamps, tail lamps, and stop light will also be on with switches in this position. **CAUTION:** Under battle conditions, the blackout driving light should be used intermittently and only when absolutely necessary for safe vision.

(h) *Starter Button.* To the right of the blackout drive switch, a starter button is provided. With the battery master switch on and when the button is pushed in, the circuit is completed through the starter solenoid closing the starting motor circuit and causes the starting motor to crank the engine.

(i) *Tachometer.* The tachometer is located on the right-hand side of the instrument panel. The throttle stop screw on the carburetor should be so adjusted that the engine will idle at 500 revolutions per minute after warmed up. The maximum speed of the engine is governed by a flyball type governor located at the rear of the right-hand cylinder head. This governor is set to limit the engine speed to 2,600 revolutions per minute under full load with wide open throttle (10-

3-INCH GUN MOTOR CARRIAGE M10A1

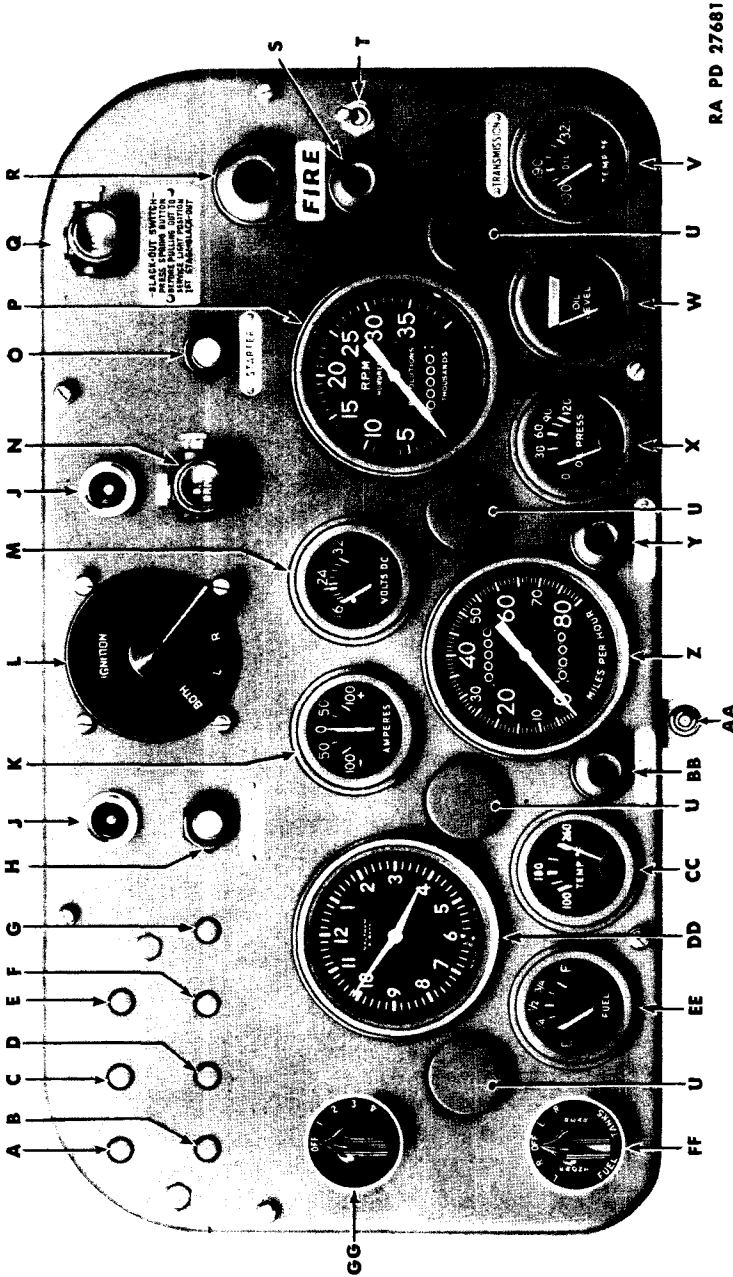


Figure 6—Instrument Panel

RA PD 27681

OPERATION AND CONTROLS

- A—CIRCUIT BREAKER FOR RIGHT HAND UTILITY  
OUTLET CIRCUIT
- B—CIRCUIT BREAKER FOR SIREN CIRCUIT
- C—CIRCUIT BREAKER FOR LEFT HAND UTILITY  
OUTLET CIRCUIT
- D—CIRCUIT BREAKER FOR FUEL CUT-OFF AND  
HULL LAMP CIRCUITS
- E—CIRCUIT BREAKER FOR BLACKOUT DRIVE  
SWITCH CIRCUIT
- F—CIRCUIT BREAKER FOR CIRCUIT FOR PANEL LIGHTS,  
FUEL GAGE, WATER TEMPERATURE, LOW OIL  
PRESSURE LIGHT, WATER BOIL SIGNAL LIGHT,  
OIL LEVEL GAGE, VOLTMETER AND TRANSMISSION  
OIL TEMPERATURE GAGE
- G—CIRCUIT BREAKER FOR FIRE DETECTOR SIGNAL  
CIRCUIT
- H—FUEL CUT-OFF SWITCH BUTTON
- J—UTILITY OUTLET
- K—AMMETER
- L—IGNITION SWITCH
- M—VOLTMETER
- N—BLACKOUT DRIVING LIGHT SWITCH
- O—STARTER BUTTON
- P—TACHOMETER
- Q—LIGHT SWITCH
- R—FIRE DETECTOR SIGNAL
- S—FIRE DETECTOR TEST LIGHT
- T—FIRE DETECTOR TEST SWITCH
- U—INSTRUMENT PANEL LIGHTS
- V—TRANSMISSION OIL TEMPERATURE GAGE
- W—OIL LEVEL GAGE
- X—OIL PRESSURE GAGE
- Y—LOW OIL PRESSURE SIGNAL
- Z—SPEEDOMETER
- AA—TRIP MILEAGE RESET
- BB—ENGINE BOIL SIGNAL
- CC—ENGINE TEMPERATURE GAGE
- DD—CLOCK
- EE—FUEL LEVEL GAGE
- FF—SELECTOR SWITCH
- GG—PANEL LIGHT RHEOSTAT SWITCH

RA PD 27681B

Legend for Figure 6—Instrument Panel



**3-INCH GUN MOTOR CARRIAGE M10A1**

inch vacuum). If during operation under full load it is possible to run the engine speeds above 2,600 revolutions per minute, or if the governor limits the speed at some point below 2,600 revolutions per minute, the ordnance maintenance personnel will be notified. If the governor is set too low it will be impossible to get maximum speed and power from the vehicle. If the governor is set too high, damage to the engine and other working parts could result.

(j) *Light Switch.* The knob on the instrument panel marked "LIGHTS" controls the service lights and the blackout driving lights. A spring-operated safety button prevents the knob from being accidentally pulled out beyond the blackout position. To release the safety button, push the button in with thumb, at the same time continuing the outward pull on the knob with the first and second fingers. The switch has three positions (besides off) controlling the lights as follows:

LIGHT SWITCH POSITION	LIGHTS OPERATING	LOCATION
Blackout— 1st position	Blackout marker lights	Top of right and left headlights
	Blackout taillights	Lower section right and left taillights
	Blackout stop light (when steering lever is pulled back)	Upper section right-hand taillight
Service— 2nd position	Service headlights	Right and left headlights
	Service taillight	Upper section left-hand taillight
	Service stop light (when steering lever is pulled back)	Upper section left-hand taillight
Stop light— 3rd position	Service stop light	Upper section left-hand taillight

(k) *Fire Detector Signal.* A red signal is provided on the right side of the instrument panel. The fire detector consists of a 32-candlepower lamp located behind a red lens. A wire from this bulb runs back to the engine compartment where several thermal switches will cause it to be grounded in case of fire. The grounding of this wire completes the circuit through the bulb with the result that the red light goes on (battery master switch must be on) warning the operator of the fire in the engine compartment (par. 5 a (1) (m)).

(l) *Fire Detector Test Light.* A fire detector circuit test light is located below the fire detector signal and consists of a 3-candlepower lamp located behind a green lens. Use of this test light is explained in the following paragraph.

(m) *Fire Detector Test Switch.* A toggle switch located to the right

## OPERATION AND CONTROLS

of the fire detector signal test light permits testing the fire detector system. When this switch is pressed up, the wire running from the signal light bulb to the thermal units is grounded, and the green signal light should go on (battery master switch must be on). If the green light fails to go on when the test switch is pressed up, the fire detector system is defective or the circuit breaker is open; press the circuit breaker button for fire detector signal circuit on the instrument panel and repeat the test.

(n) *Instrument Panel Lights.* Four instrument panel lights are provided in the panel. These lights are turned on or off and their brilliancy is controlled by a panel light rheostat.

(o) *Transmission Oil Temperature Gage.* An oil temperature gage having a range of from 100 F to 325 F indicates the temperature of the oil in the transmission. In normal operation, the temperature of the transmission oil should not exceed 200 F. The most common cause of overheating is too much oil in the transmission. Check the level of the transmission oil (fig. 13).

(p) *Engine Oil Level Gage.* An oil level gage indicates whether sufficient oil is carried in the engine oil pan. As long as the oil level gage pointer is in the green sector, the oil level is satisfactory. When the reading drops to the red sector, oil should be added to bring the oil level up to the 32-quart or "FULL" mark on the bayonet gage at rear of engine (fig. 19).

(q) *Oil Pressure Gage.* The engine oil pressure gage is located beneath the tachometer. At normal operating temperatures with the engine running at cruising speed (2,600 revolutions per minute), the oil pressure should be between 60 and 80 pounds. The oil pressure will be reduced as engine speed is decreased. If during operation the oil pressure drops off slowly, it may be due to a change in the viscosity of the oil due to overheating. Check engine temperature.

(r) *Low Oil Pressure Signal.* To the left of the oil pressure gage, a red plastic lens-type light, that signals the driver when the oil pressure drops below 11 pounds, is provided.

(s) *Speedometer.* The speedometer is located in the center of the instrument panel at the bottom, and is equipped with a trip mileage reset at the bottom of the instrument panel.

(t) *Engine Boil Signal.* To the left of the speedometer, a red plastic lens-type light, that signals the driver when the temperature in the cooling system reaches 235 F, is provided. Should this signal light, stop the engine and investigate and correct cause of overheating (par. 36 k); otherwise, serious damage to the engine may result.

(u) *Engine Temperature Gage.* The engine temperature gage is located to the left of the speedometer and is calibrated from 100 to 260 degrees. The gage operates only when the battery master switch is on. The indicator hand rests at the hot end of the gage when the

**3-INCH GUN MOTOR CARRIAGE M10A1**

master switch is off. The cooling system is sealed and not open to atmospheric pressure, with the result that the boiling point of the coolant and consequently overheating actually does not occur until a temperature of approximately 235 F is reached. In normal operation when atmospheric temperature is above 60 F under maximum power on a level hard surface, the engine temperature should not be greater than 90 F above existing surrounding temperature.

(v) *Clock.* Directly beneath the seven circuit breaker buttons, an 8-day clock is provided. A reset and rewinding knob is located at the bottom of the dial.

(w) *Fuel Level Gage and Selector Switch.* In the lower left-hand corner of the instrument panel, a selector switch and fuel level gage permit the checking of the fuel level in each of the four fuel tanks. The selector switch has five positions. With the selector switch in off position, the fuel level gage will read "E" (empty). To check the fuel level in right front tank, turn switch to the left to "R." To check the fuel level in left front tank, turn switch all the way to the left to "L." To check the fuel level in left rear tank, turn switch to the right to "L." To check fuel level in the right rear tank, turn switch all the way to the right to "R."

(x) *Panel Light Rheostat Switch.* To the left of the clock, a 5-position rheostat is provided which is used to turn the panel lights on or off and control their brilliance.

**b. Controls (fig. 7).**

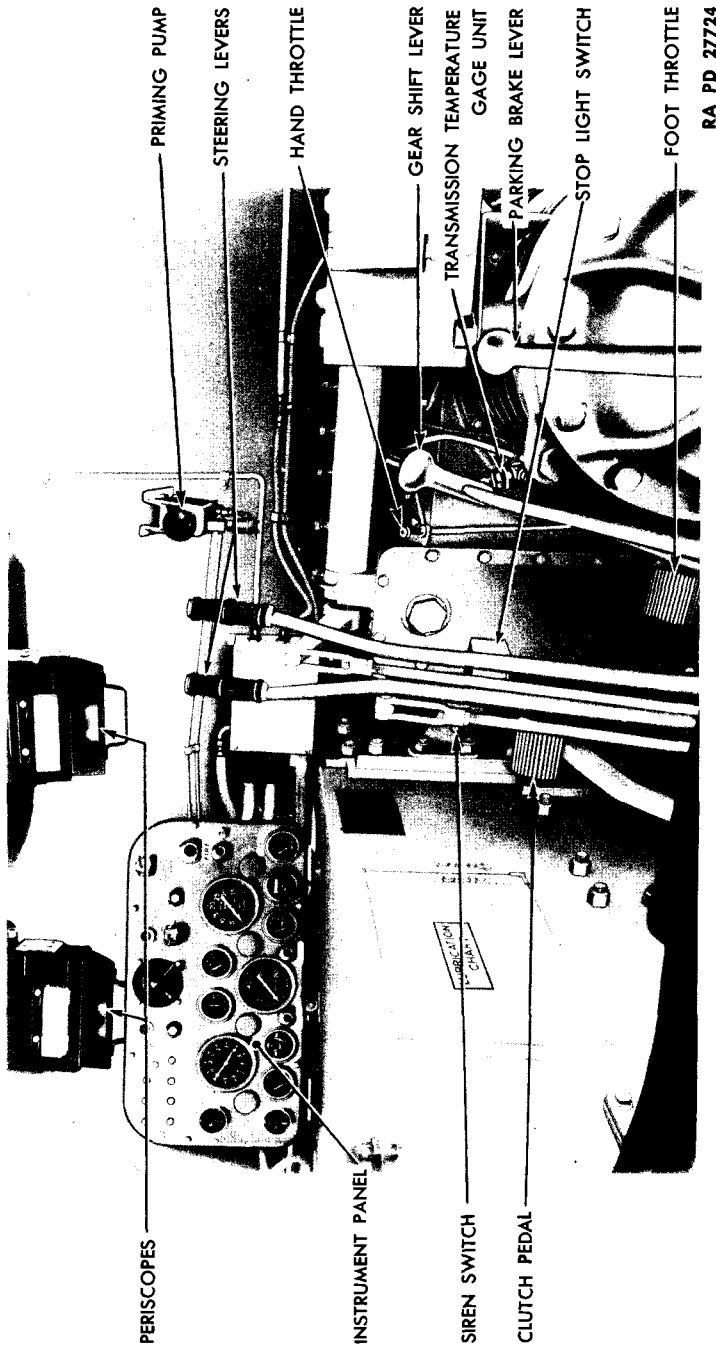
(1) **SPARK CONTROL.** The spark advance control is entirely automatic and requires no attention by the operator of the vehicle.

(2) **FOOT THROTTLE.** A foot throttle pedal is located on the floor in front of the driver's seat, convenient to the driver's right foot.

(3) **HAND THROTTLE.** In conjunction with the foot pedal, a hand-operated throttle is provided. The hand throttle is bracket-mounted to the differential case directly above the foot throttle. Press on the foot throttle to assist pulling out the hand throttle. A lock button is located in the center of the hand throttle button. This lock button holds the hand throttle at the desired setting. To close the hand throttle, press the lock button.

(4) **PRIMING PUMP.** The priming pump is located on the front slope in the driver's compartment. To operate the priming pump, the knob is pulled out and pushed back in. This causes a quantity of gasoline to be forced directly into the intake manifold for cold weather starting. The priming pump is used in place of the conventional choke. Ordinarily it will not be necessary to use the primer except during cold weather. Excessive priming of the engine will cause flooding and failure to start, and the excess gasoline will wash the oil from the cylinder walls with the result that the cylinders will not be properly lubricated until the engine oil starts circulating.

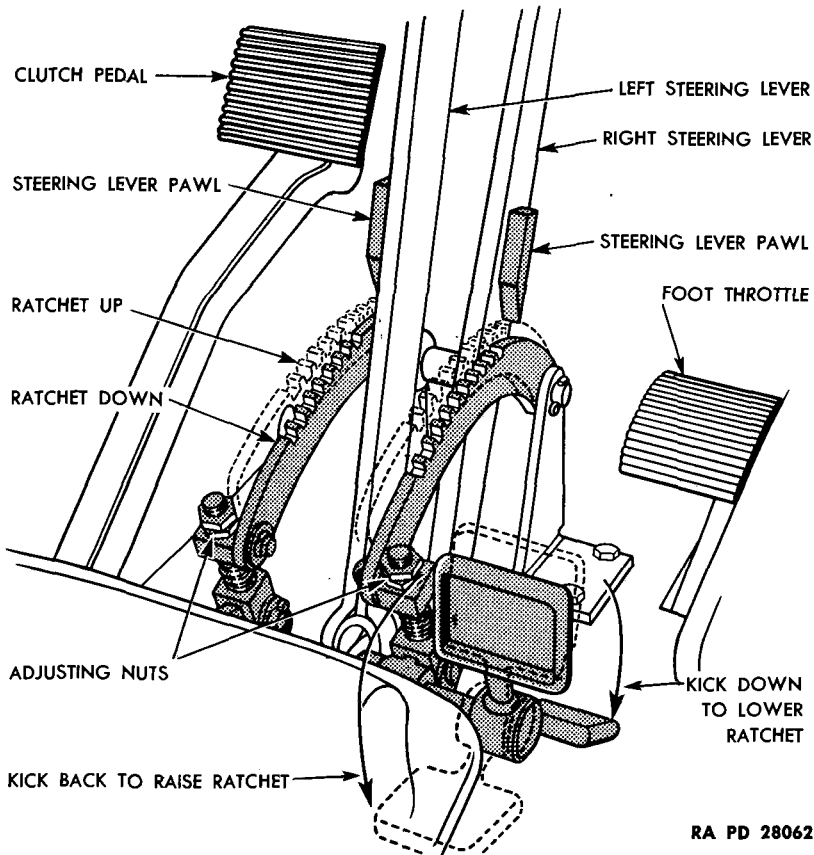
OPERATION AND CONTROLS



RA PD 27724

Figure 7 — Driver's Compartment

3-INCH GUN MOTOR CARRIAGE M10A1



RA PD 28062

**Figure 8—Steering Levers Retractable Ratchets for Holding Brakes On**

(5) **STEERING LEVERS.** Two steering levers are mounted on the floor of the vehicle, in front of the driver's seat. To steer the vehicle, pull the steering lever on the side toward which it is desired to turn. Pulling back either one of the levers slows down the track on that side, while the speed of the other track is increased.

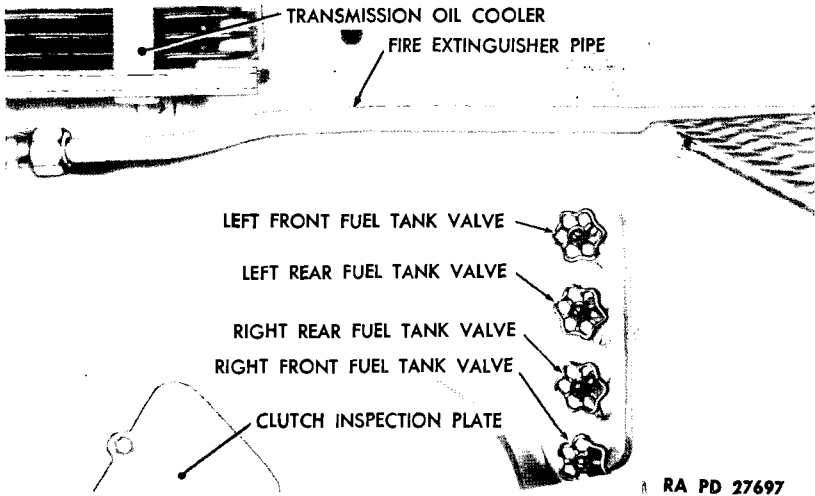
(6) **SERVICE BRAKES.** Pulling back simultaneously on both steering levers slows down or stops the vehicle, depending on the effort applied.

(7) **PARKING BRAKE.**

(a) *Types of Parking Brakes.* Two types of parking brakes have been used on the 3-inch Gun Motor Carriage M10A1 as follows:

1. *Original design.* The original design provided a parking brake lever located to the right of the driver, at rear of the transmission (fig. 7). The original design was a transmission type brake and

## OPERATION AND CONTROLS



**Figure 9—Fuel Shut-off Valves**

should never be used for any purpose other than parking. Always be sure this type parking brake is released (all the way forward), before moving the vehicle.

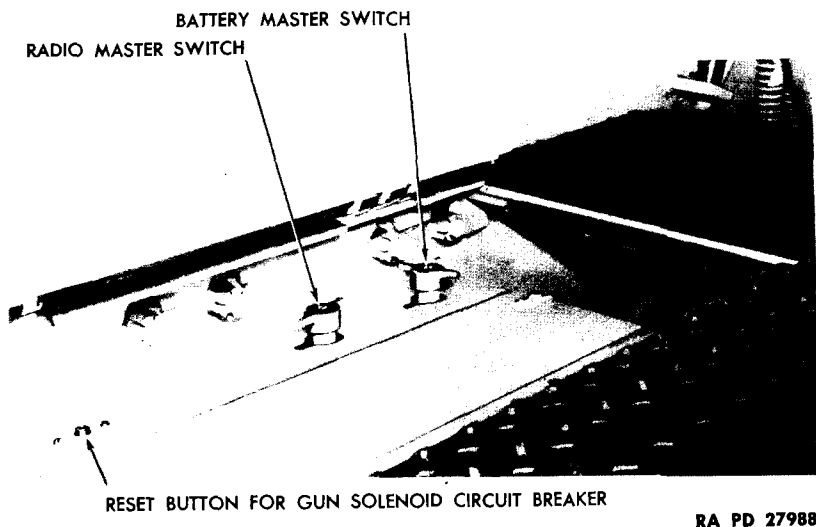
2. *Later design.* On later design 3-inch gun motor carriages the steering levers are each provided with a pawl that operates on retractable quadrant ratchets (fig. 8). The ratchets are raised by pressing the ratchet control pedal forward and down. This permits the steering lever pawls to engage in the ratchet teeth holding the service brakes on while parking. To release the service brakes, pull back on both steering levers and press the ratchet pedal forward and down. This retracts or lowers the ratchets and the service brakes are released. Always be sure that ratchet forward pedal is all the way down before operating the vehicle.

(8) **CLUTCH PEDAL** (fig. 7). The clutch pedal is located on the floor in front of driver's seat, convenient to the driver's left foot. To permit shifting of gears, the clutch is disengaged by depressing the clutch pedal. At any time when the clutch pedal free play becomes less than 2 inches, the clutch pedal should be adjusted (par. 115 d). *Do not ride the clutch pedal.*

(9) **FUEL SHUT-OFF VALVES** (fig. 9). Four shut-off valves (one for each fuel tank) are located on the bulkhead to the left rear of the fighting compartment.

(10) **BATTERY MASTER SWITCH** (fig. 10). The battery master switch is located approximately 30 inches to the rear of the driver's seat. This switch is on when all the way down. To turn off, raise the knob approximately one-fourth inch and turn so that switch stays in

## 3-INCH GUN MOTOR CARRIAGE M10A1



RA PD 27988

**Figure 10—Battery and Radio Master Switches—Location**

its up position. When this switch is off, all electrical power is shut off at the battery (with the exception of the power used by the radio which is controlled by a separate radio master switch). If in doubt as to whether the battery master switch is on or off, the following can serve as a guide. When the battery master switch is on, the voltmeter will show approximately 24 volts. When the battery master switch is off, the voltmeter will read at the 16-volt mark. Also when the battery master switch is on, the oil level gage will indicate the oil level and should read in the green section.

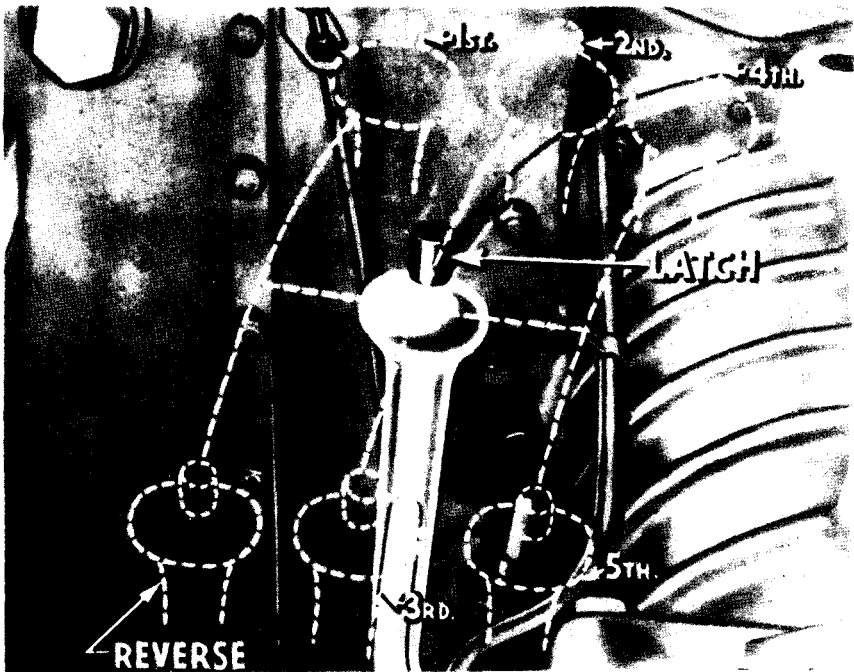
(11) **RADIO MASTER SWITCH** (fig. 10). The radio master switch is located directly back of the battery master switch and turns on and off the same way as outlined above for the battery master switch.

(12) **FIRING SOLENOID CIRCUIT BREAKER** (fig. 53). A circuit breaker located in the battery box opens the circuit of the gun firing solenoid and relay if it should become overloaded. The button controlling the circuit breaker (fig. 10) is located on top of the battery box to the rear of the radio master switch. Pressing this button will reset the circuit breaker.

(13) **GEARSHIFT LEVER** (fig. 7).

(a) *Description.* Shifting of gears in the transmission for speed changes is accomplished by the gearshift lever, located on the left side of the transmission, to the right of the driver. The positions of the gearshift lever for the various speeds are shown in figure 11. The gearshift lever is equipped with a latch which prevents accidental shifting into first speed or reverse. The latch must be released by pressing

## OPERATION AND CONTROLS



RA PD 27493

**Figure 11—Gearshift Lever Positions**

down the button on top of the lever before shifting into first speed or reverse.

(b) *Operation.* When it is desired to shift to low or reverse, the following procedure will make the shift possible without the clashing of gears which otherwise usually results. From neutral, move the gearshift lever as though to shift into third gear. Maintain pressure in this direction long enough to stop the propeller shaft and then, with the clutch still held out, shift smartly into low or reverse. If when shifting to any of the higher speeds, there is a raking of gears, go back to neutral and, still holding the clutch out, start the shift over. *Do not attempt to complete a shift that begins with a clashing of gear teeth.*

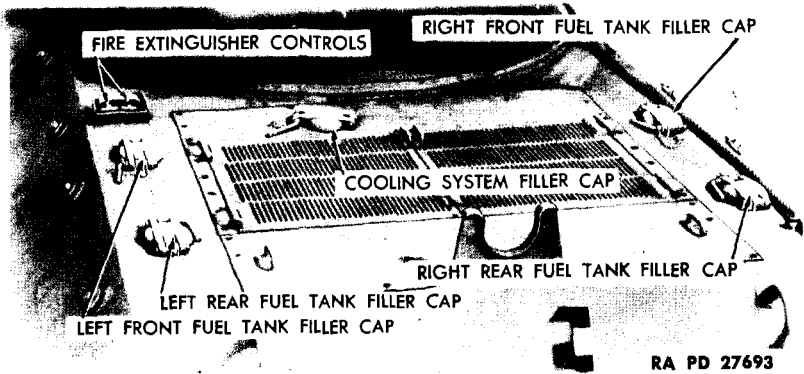
(14) FIRE EXTINGUISHER OPERATION AND CONTROLS.

(a) *Portable Extinguishers.* Carry portable extinguisher in left hand and hose in right hand. Direct the discharge at base of flame, with discharge cone as close to flame as operator can safely hold it. Increase the discharge from extinguisher as the fire is put out.

(b) *Fixed Extinguishers.* In case of a fire in the engine compartment, the fixed extinguisher can be set in operation from the outside of the vehicle by means of the controls located behind and to the left of the turret (fig. 12) or by means of the controls in the driver's compartment located almost directly over the driver's left shoulder. In



## 3-INCH GUN MOTOR CARRIAGE M10A1



**Figure 12—Fuel and Water Fillers**

either case the left-hand control, when pulled out, opens one fixed extinguisher, and the right-hand control opens the other extinguisher. Either floods the engine compartment with carbon-dioxide gas, and will extinguish a fire with the engine running up to 1,200 revolutions per minute. If conditions permit, however, stop the engine.

(15) **PERISCOPES.** Two periscopes are provided for the driver, one in the driver's door, the other to his left, mounted in the hull top plate. A third periscope is in the assistant driver's door. Each periscope is mounted in a revolving plate which permits vision in any direction. The periscope mounts can be tilted to raise or lower the line of vision. Lock screws are provided to hold the mounts stationary when desired. Each periscope is held in place in its mount by a knurled nut on the back. A safety lock on the periscope housing prevents the device from falling out if the holding nut becomes loosened. Two spare periscopes and six spare heads are carried in boxes mounted on top of the transmission.

## 6. PRESTARTING INSPECTION.

a. **General Instructions.** The vehicle has a crew of five men and it is essential that all men be utilized in inspection of the vehicle under the direction of the vehicle commander. The inspection should cover the vehicle as well as the engine (par. 19).

## 7. STARTING INSTRUCTIONS.

a. **General.** Before attempting to start the engine, familiarize yourself with all of the various instruments and controls (par. 5). Make sure that the function of each instrument and control is thoroughly understood, and that the significance of the readings on the various instruments is appreciated.

b. **Warm Weather Starting (Above 40 F).** Open fuel shut-off

## OPERATION AND CONTROLS

valves (fig. 9). Turn battery master switch on (par. 5 b (10)). Put gearshift lever in neutral (fig. 11). Depress foot throttle (fig. 7) and pull hand throttle out about one-fourth inch. Turn ignition switch (fig. 6) to "BOTH" position. If engine is cold, use three to five strokes on the foot throttle pedal. Press starter button. Engine should start readily. If engine does not start see paragraph 36. If engine starts but fails to continue to run, several strokes of the foot throttle just before engine stops usually will keep it running.

c. **Cold Weather Starting (Below 40 F).** Open fuel shut-off valves (fig. 9). Turn battery master switch on (par. 5 b (10)). Put gearshift lever in neutral (fig. 11). Depress foot throttle and pull hand throttle out about one-fourth inch. Turn ignition switch (fig. 6) to the "BOTH" position. Prime engine using three to five strokes of priming pump (par. 5 b (4)). Press starter button at same time holding clutch pedal all the way down until engine starts. As engine starts, it may be necessary to use the priming pump again; also two or three quick strokes of foot throttle will assist in keeping engine running by supplying additional fuel. If the engine fails to start see paragraph 36.

### 8. ENGINE TEST.

a. As soon as the engine starts, check oil pressure (par. 5 a (1) (q)). Stop engine if oil pressure is not indicated in 30 seconds. Check operation of instruments and switches while engine is idling. Idle engine until engine temperature gage reads above 100 F. When engine is sufficiently warm, set hand throttle to 600 revolutions per minute. Run engine on each magneto (par. 5 a (1) (e)) and compare tachometer reading obtained with each with the reading obtained when both magnetos were used (600 revolutions per minute). If, when running on either one of the magnetos, the engine speed drops to less than 500 revolutions per minute, the cause should be investigated (par. 44 i and j). Push hand throttle in to reestablish normal idling speed. (Carburetor stop screws should be set to idle engine at 500 revolutions per minute after warming up.) *Never idle engine at less than 500 revolutions per minute.*

### 9. STOPPING THE ENGINE.

a. After completing a run, the engine must be allowed to operate at 500 revolutions per minute for 2 minutes to assure a gradual and uniform cooling of the valves and other various engine parts. To stop the engine hold fuel cut-off switch button in until engine stops; then turn ignition switch to off position.

### 10. OPERATING THE VEHICLE.

a. **Preliminary Instructions.** Before attempting to drive the vehicle, the prospective driver should be thoroughly familiar with all the instruments and the significance of their readings (par. 5 a). He

**3-INCH GUN MOTOR CARRIAGE M10A1**

must also know the function and operation of the controls in his compartment (par. 5 b). Review of paragraph 4 k will be helpful. The limitations of vehicle and engine are covered under paragraph 4 l. When starting out with a cold engine with the fuel tanks full of cold fuel, it is important to use in turn three or four gallons of fuel from each of the tanks to provide expansion space for the fuel as its temperature raises from the heat of the engine. Generally speaking, 3 or 4 miles from each tank will provide sufficient expansion space. With the engine at idling speed, and all instruments showing normal readings, the driver may now operate the vehicle.

**b. Setting the Vehicle in Motion.** Release parking brake (par. 5 b (7)). Disengage clutch by pressing clutch pedal (fig. 7) down to the floor and holding it down. Move gearshift lever into second gear position (fig. 11) for normal operation. (First gear will be used only when shifting vehicle in buildings or over obstacles.) Gradually release clutch pedal, at the same time depressing foot throttle.

(1) Except when under fire, do not move the vehicle in or out of close quarters without the aid of personnel outside of the vehicle serving as a guide.

(2) To avoid serious injuries to personnel or damage to the vehicle, do not operate the vehicle until both turret traversing locks are securely fastened. The traversing mechanism, although it acts as an auxiliary brake on the turret, is not by itself strong enough to lock the turret while traveling, particularly over rough terrain. If the traversing mechanism breaks because the primary locks are not engaged, the gun tube will swing around and strike the heads of the driving crew, causing serious injury and possibly further damage to the vehicle.

**c. Shifting Gears.** When the vehicle has started and is moving with engine speed of 1,200 revolutions per minute, release foot throttle, depress clutch again, and move gearshift lever into third gear position. Release clutch and again depress foot throttle to pick up the load of the vehicle. Repeat above procedure until the highest gear is reached which will enable the vehicle to proceed at the desired speed without causing the engine to labor. Do not ride the clutch. Driver's left foot must be completely removed from the clutch pedal while driving, to avoid unnecessary wear and burning out the clutch. (Clutch pedal should be readjusted when the free travel drops to 2 inches or less (par. 115 d).)

**d. Reversing the Vehicle.** To place the vehicle in reverse gear, a complete stop must be made. Close throttle until the tachometer reads 500 revolutions per minute (lowest idling speed). Depress clutch pedal and move gearshift lever to the reverse position (fig. 11). Backing the vehicle should never be attempted unless an observer is stationed in front to guide the driver.

## OPERATION AND CONTROLS

e. **Steering the Vehicle.** To steer the vehicle, pull back right-hand steering lever to make a right turn, or left-hand lever for a left turn. This action "brakes" the track on the inside of the turn and speeds up the outside track. The driver should anticipate each turn and be ready to apply more power as it is needed to compensate the braking effort. The hands should be free of the steering lever when not actually steering the vehicle.

f. **Operation on Hand Pulls.** Never lug engine below 1,000 revolutions per minute at wide open throttle. Shift to a lower gear (fig. 11). Check oil pressure, oil level, and engine temperature frequently.

g. **Descending Grades.** Care must be taken while descending steep grades to shift to a low enough gear to control the vehicle speed and use the steering brake to keep the engine speed. Failure to follow this procedure may cause failure of the propeller shaft and transfer case coupled with serious injury to the crew. The following cautions should be observed when descending a steep grade.

(1) Never release the clutch and allow the propeller shaft to reach a speed beyond its capacity. When the vehicle is in low gear, every mile-per-hour increase in speed will increase the propeller shaft speed 1,000 revolutions per minute.

(2) Never release the clutch momentarily and then engage it while descending a steep grade, thus imposing too great a load on the propeller shaft and transfer case.

(3) Shift to a low enough gear to control the speed of the vehicle.

(4) Use the steering brake to keep the engine speed, as indicated by the tachometer within the maximum allowable revolutions per minute of the power units. The maximum allowable for the power units of the M10A1 are 2,600 revolutions per minute.

h. **Stopping the Vehicle.** To stop the vehicle, release throttle and pull back on both steering levers at the same time. Depress clutch pedal when the vehicle has slowed down to approximately 2 to 5 miles per hour, depending upon which gear is being employed before stopping. Set the hand throttle for a tachometer reading of 500 revolutions per minute for the duration of the halt.

i. **The Use of Gages on the Instrument Panel.** The tachometer, oil temperature gage, and oil pressure gage give the most satisfactory indications of the engine's performance. Should the indications of any of these instruments appear to be irregular, the engine should be stopped and the cause investigated.

## 11. TOWING INSTRUCTIONS.

a. **General.** A towing shackle is mounted on each corner of the hull of the vehicle about 20 inches from the ground. Two of these shackles are mounted in front and two in the rear. These shackles provide a quick method of attaching either a towing bar or cables.

**3-INCH GUN MOTOR CARRIAGE M10A1**

**b. Precautions When Towing.** If there are tracks on the vehicle to be towed, always disconnect the propeller shaft at the transmission companion flange and leave the vehicle in fifth gear. This procedure insures adequate circulation of the transmission oil while the vehicle is in motion. If the tracks are removed before towing the vehicle, this precaution is not necessary. In towing, there are several precautions that the driver must take to avoid trouble or unnecessary delay. Changes of direction are always to be made by a series of slight turns so that the vehicle being towed is as nearly as possible, directly behind or "tracking" the one doing the towing. This will prevent the cable from contacting the track, which might damage both the cable and the track blocks. Soft muddy ground is to be avoided, since the tracks may slip on such a surface. If it is necessary to cross a muddy area, the driver should be careful to straighten out both vehicles before entering it, as it is more difficult to pull at an angle than when following in tow. On vehicles equipped with rubber block tracks, grousers may be installed as required. The maximum speed when towing should be not more than 12 miles per hour and then only with an operator for steering and braking the towed vehicle.

**c. Handling of Towing Cable.** Except in cases where a "short hitch" is absolutely necessary a towing cable will not be coupled to another vehicle by other than the thimble eyes provided at both ends. Doubling the cable causes sharp bends in the wire rope which will cause rapid failure of the strands and will leave the cable extremely dangerous to handle. When a "short hitch" is desired, the two eyes of the cable are attached to the towing vehicle. The cable with leads crossed, is then passed through both shackles of the towed vehicle. This provides an arrangement having a minimum of bending action and movement at the shackles, and furnishes clearance between cable and tracks.

**d. Method of Towing.** If no operator is available to steer the disabled vehicle, one cable will facilitate tracking of the towed vehicle. Care must be taken on turning, not to get the cable tangled up with the track of either vehicle.

Section IV

OPERATION UNDER UNUSUAL CONDITIONS

	Paragraph
Cold weather starting . . . . .	12
Operation at high temperatures . . . . .	13
Operation at high altitudes . . . . .	14
Operation in sand . . . . .	15
Operation on slippery terrain . . . . .	16
Operation under dusty conditions . . . . .	17

12. COLD WEATHER STARTING.

a. **Starting With Starting Motor.** When starting the engine in cold weather, it is doubly important to follow the starting procedure outlined in paragraph 7 c. If this procedure is followed, few additional instructions are required. Briefly stated, cold weather starting problems are nearly always the result of poor preparation or maintenance of the vehicle and in addition to the causes of failure to start as outlined in paragraph 36, can be attributed either to the engine oil being too heavy for the temperatures encountered or the batteries being low in charge. In sub-zero temperatures, a battery that has set over night will have a capacity much lower than at normal temperatures.

b. **Towing to Start. CAUTION:** If the engine is forced to turn over while there is water, antifreeze, or oil in the cylinders above the pistons (as a result of condensation or leakage), breakage of internal parts of the engine will result. Turn the engine over three complete revolutions by hand (fig. 35) prior to towing. Never use other than fifth gear (fig. 11) when towing the vehicle to start the engine.

(1) **TURN ENGINE OVER.** Leave the ignition switch off. Tow the vehicle several feet with the transmission in neutral (fig. 11) to remove the slack from the towing line and to break the track loose from the frozen ground. Depress the clutch and place the gearshift lever in fifth gear (fig. 11). Tow the vehicle at 1 mile per hour and engage the clutch gradually (permitting it to slip) until two complete revolutions of the engine have been made. If the engine will not turn over with the clutch slipping, discontinue attempting to start and notify ordnance maintenance personnel.

(2) **START THE ENGINE.** After the engine has been turned over as outlined above, turn the ignition switch on and engage the clutch. Increase towing speed to from 3 to 5 miles per hour (in fifth gear, fig. 11) and make from 3 to 5 strokes with the priming pump. If the engine does not start, see paragraph 36.

13. OPERATION AT HIGH TEMPERATURES.

a. When operating at high temperatures, observe the engine temperature gage frequently and add water to the cooling system as often

**3-INCH GUN MOTOR CARRIAGE M10A1**

as may be required to prevent overheating. The viscosity of the various oils used decreases at higher temperatures. Be sure oils are being used with sufficient body to match the temperature. Engine oil thinned out by high temperatures is used up more rapidly. Check the engine oil level frequently.

**14. OPERATION AT HIGH ALTITUDES.**

a. High altitudes result in a lowering of compression due to lowered atmospheric pressure and a corresponding lowering of the developed horsepower. Due to rarefied atmosphere, a smaller quantity of air is taken into each cylinder while the quantity of fuel remains practically the same as at sea level. This results in the fuel air mixture being too rich. This can only be remedied by reducing the size of the various carburetor jets if the vehicle is to be operated continually at high altitudes. Generally speaking, elevations up to 5,000 feet present no particular problems and can be considered as normal.

**15. OPERATION IN SAND.**

a. Desert operation and operations under extremely sandy road conditions may necessitate cleaning the air cleaner as often as every 2 hours. When operating in sand deep enough to force the use of lower gear ratios, do not exceed the speed specified for the particular gear ratio (par. 4 k).

**16. OPERATION ON SLIPPERY TERRAIN.**

a. For operation in mountainous terrain, in mud, or over ice and snow, where sufficient traction is not normally possible, grousers are provided for use on certain types of track. When operating on slippery terrain start vehicle carefully by engaging clutch gradually; do not attempt to turn until after vehicle is moving at normal speed. Tracks and bogies should be periodically cleaned of mud, snow, or ice.

**17. OPERATION UNDER DUSTY CONDITIONS.**

a. In operating the vehicle cross country on dry, dusty ground along with other vehicles, avoid running in the dust cloud of other vehicles as much as possible. When operating in single file on dusty roads where no cross wind exists, space the vehicles far enough apart to reduce the dust hazard as much as possible if practicable. Even when the above precautions are taken, it may be necessary to clean the air cleaner as often as every 2 hours (par. 55). If the air cleaners are kept clean and their oil level is maintained, little damage to the engine will result. On the other hand, if the air cleaners run dry, it is possible to wear out an engine in 1 hour or less.

Section V

PREVENTIVE MAINTENANCE INSPECTIONS AND SERVICE

	Paragraph
Purpose .....	18
Before-operation service .....	19
During-operation service .....	20
At-halt service .....	21
After-operation and weekly service .....	22

**18. PURPOSE.**

a. To insure mechanical efficiency, it is necessary that the vehicle be systematically inspected at intervals each day it is operated, and weekly, so defects may be discovered and corrected before they result in serious damage or failure. Certain scheduled maintenance services will be performed at these designated intervals. The services set forth in this section are those performed by driver or crew, before-operation, during-operation, at-halt, and after-operation and weekly.

b. Driver preventive maintenance services are listed on the back of Driver's Trip Ticket and Preventive Maintenance Service Record W.D. Form No. 48 to cover vehicles of all types and models. Items peculiar to specific vehicles but not listed on W.D. Form No. 48 are covered in manual procedures under the items with which they are related. Certain items listed on the form that do not pertain to the vehicle involved are eliminated from the procedures as written into the manual. Every organization must thoroughly school each driver in performing the maintenance procedures set forth in manuals, whether they are listed specifically on W.D. Form No. 48 or not.

c. The items listed on W.D. Form No. 48 that apply to this vehicle are expanded in this manual to provide specific procedures for accomplishment of the inspections and services. These services are arranged to facilitate inspection and conserve the time of the driver, and are not necessarily in the same numerical order as shown on W.D. Form No. 48. The item numbers, however, are identical with those shown on that form.

d. The general inspection of each item applies also to any supporting member or connection, and generally includes a check to see whether the item is in good condition, correctly assembled, secure, or excessively worn.

e. The inspection for "good condition" is usually an external visual inspection to determine whether the unit is damaged beyond safe or serviceable limits. The term good condition is explained further by the following terms: Not bent or twisted, not chafed or burned, not broken or cracked, not bare or frayed, not dented or collapsed, not torn or cut.



### **3-INCH GUN MOTOR CARRIAGE M10A1**

f. The inspection of a unit to see that it is "correctly assembled" is usually an external visual inspection to see whether it is in its normal assembled position in the vehicle.

g. The inspection of a unit to determine if it is "secure" is usually an external visual examination, a hand-feel, or a pry bar check for looseness. Such an inspection should include any brackets, lock washers, lock nuts, locking wires, or cotter pins used in assembly.

h. "Excessively worn" will be understood to mean worn, close to or beyond serviceable limits, and likely to result in a failure if not replaced before the next scheduled inspection.

i. Any defects or unsatisfactory operating characteristics beyond the scope of first echelon to correct must be reported at the earliest opportunity to the designated individual in authority.

### **19. BEFORE-OPERATION SERVICE.**

a. This inspection schedule is designed primarily as a check to see that the vehicle has not been tampered with, or sabotaged since the after-operation service was performed. Various combat conditions may have rendered the vehicle unsafe for operation and it is the duty of the driver to determine whether or not the vehicle is in condition to carry out any mission to which it is assigned. This operation will not be entirely omitted, even in extreme tactical situations.

b. **Procedures.** Before-operation service consists of inspecting items listed below according to the procedure described, and correcting or reporting any deficiencies. Upon completion of the service, results should be reported promptly to the designated individual in authority.

(1) **ITEM 1, TAMPERING AND DAMAGE.** Examine hull, armament, tracks, volute suspensions, engine compartment, and turret for evidence of tampering or sabotage.

(2) **ITEM 4, ACCESSORIES AND DRIVES.** Examine all accessories such as carburetors, generators, fuel pump, starter, fans and shrouds, and water pump for loose connections, mountings, and for leaks.

(3) **ITEM 3, FUEL, OIL, AND WATER.** Inspect tanks, filler caps, lines, hoses, and connections for evidence of leaks or tampering. Read fuel and oil gage on instrument panel and inspect water level in expansion tanks. Add if necessary.

(4) **ITEM 6, LEAKS, GENERAL.** Look on ground under vehicle and around final drive for evidence of oil leaks.

(5) **ITEM 8, PRIMER.** While starting the engine, observe for proper operation of the primer.

(6) **ITEM 7, ENGINE WARM-UP.** Close battery master switch. Ammeter must read "ZERO." Voltmeter must read 26 to 28 volts to indicate fully charged battery. Open fuel tank selector valves and

**PREVENTIVE MAINTENANCE INSPECTIONS AND SERVICE**

start engine. Run engine at 600 revolutions per minute with transmission in neutral until water temperature reads above 100 F.

(7) **ITEM 9, INSTRUMENTS.**

(a) *Oil Pressure Gage.* Must read 60 to 80 pounds when engine is operating at 2,600 revolutions per minute, and not fall below 11 pounds when idling. Stop engine immediately if red indicator lights come on.

(b) *Ammeter.* Must show a high charging rate for first few minutes. A high charging rate for extended period with all electrical units turned off, indicates a discharged battery or faulty regulator.

(c) *Voltmeter.* Must not read more than 30 volts. Excessive voltage indicates a faulty regulator.

(d) *Engine Temperature Gages.* Should rise slowly during warm-up period until 110 F is reached. Stop engine if temperature exceeds 235 F. Normal temperature is 90 F above atmospheric temperature.

(e) *Transmission Oil Temperature Gage.* Reading must be 120 F before driving vehicle. Transmission must be operated in neutral during engine warm-up period. Stop engine if temperature exceeds 200 F.

(f) *Tachometers.* Must register accumulated revolutions and operate without fluctuating or grinding. Engine speed must not exceed 2,600 revolutions per minute. Correct engine idling speed is 500 revolutions per minute.

(g) *Clock.* Must be wound, running, and indicate correct time.

(h) *Fuel Gage.* Should indicate the correct amount of fuel in each of the four tanks.

(i) *Engine Oil Level Gage.* Pointer should remain in green sector while engine is running. Stop engine and investigate if pointer moves to red sector.

(8) **ITEM 10, SIREN.** Sound siren for proper tone if tactical situation permits.

(9) **ITEM 12, LIGHTS.** If tactical situation permits, turn all light switches to "ON" position; inspect all lights to see that they are burning, securely mounted, clean, and that they go out when switches are turned off.

(10) **ITEM 13, SPROCKET NUTS.** Examine sprocket cap screws and hub nuts to determine that they are present and secure.

(11) **ITEM 14, TRACKS.** Inspect tracks for evidence of tampering or sabotage since the after-operation inspection.

(12) **ITEM 15, SPRINGS AND SUSPENSIONS.** Inspect bogie suspensions, rollers, sprockets, and idlers for any damage such as shell fire, accident, or sabotage.

(13) **ITEM 18, TOWING CONNECTIONS.** Towing shackles, pins, and pintle hook must be in usable condition.

(14) **ITEM 20, DECONTAMINATOR.** Must be fully charged and securely mounted. Shake to determine contents.

**3-INCH GUN MOTOR CARRIAGE M10A1**

(15) **ITEM 21, TOOLS AND EQUIPMENT.** Inspect all tools and equipment for condition, proper stowage and serviceability, using the On Vehicle Material List.

(16) **ITEM 23, DRIVER PERMIT AND FORM NO. 26 (ACCIDENT REPORT FORM).** Must be present, legible, and safely stowed.

(17) **ITEM 2, FIRE EXTINGUISHER.** Inspect portable fire extinguishers to see that they are in place, securely mounted, and that seals are not broken. Inspect fixed fire extinguisher system to see that pull handles and control head handles have not been operated and that red sealing caps are intact. Nozzles must be free from obstructions.

(18) **ITEM 22, ENGINE OPERATION.** After proper operating temperature has been reached, notice if engine idles smoothly. Accelerate engine a few times while listening for excessive vibration or unusual noises.

(19) **ITEM 25, DURING-OPERATION SERVICE.** Immediately after putting the vehicle in motion, start the during-operation service.

**20. DURING-OPERATION SERVICE.**

a. While vehicle is in motion, listen for any sounds such as rattles, knocks, squeals, or hums that may indicate trouble. Look for indications of trouble in cooling system and smoke from any part of the vehicle. Be on the alert to detect any odor of overheated components or units such as generator, brakes or clutch, fuel vapor from a leak in fuel system, exhaust gas, or other signs of trouble. Any time the brakes are used, gears shifted, or vehicle turned, consider this a test and notice any unsatisfactory or unusual performance. Watch the instruments constantly. Notice promptly unusual instrument indication that may signify possible trouble in system to which the instrument applies.

b. **Procedures.** During-operation services consist of observing items listed below according to the procedures following each item, and investigating any indications of serious trouble. Notice minor deficiencies to be corrected or reported at earliest opportunity, usually next scheduled halt.

(1) **ITEM 26, STEERING BRAKES.** Apply both steering brakes at slow speed to test for effectiveness. Free travel must be 4 to 6 inches. Test each brake for effective steering with moderate application.

(2) **ITEM 27, HAND BRAKES.** Stop vehicle and apply parking brake. Must hold vehicle stationary on a reasonable incline.

(3) **ITEM 28, CLUTCHES.** Test free travel of pedal, which must be 3½ inches. Clutch must fully release and must not slip or chatter. After shifting gears listen for noisy release bearing.

(4) **ITEM 29, TRANSMISSION.** Gears must shift smoothly, operate quietly, and not slip out of mesh. Stop vehicle in case of grinding or any unusual noise.

## PREVENTIVE MAINTENANCE INSPECTIONS AND SERVICE

(5) **ITEM 31, ENGINE AND CONTROLS.** Note power when accelerating, excessive smoking, detonation, misfiring, stalling, or overheating. Test governor control. Maximum full load speed is 2,600 revolutions per minute.

(6) **ITEM 32, INSTRUMENTS.**

(a) *Oil Pressure Gage.* Must register 60 to 80 pounds at operating speeds. Stop engine if red indicator light comes on.

(b) *Ammeter.* Will show a high charging rate for first few minutes. A high charging rate for extended period with all electrical units turned off, indicates a discharged battery or faulty regulator.

(c) *Engine Temperature Gage.* Normal reading is 60 F above atmospheric temperature. Should reading exceed 235 F, stop engine and investigate.

(d) *Transmission Temperature Gage.* Reading must not exceed 200 F.

(e) *Tachometer.* Must register engine speed and accumulated crankshaft revolutions.

(f) *Speedometer.* Must register correct speed and accumulated mileage without noise.

(g) *Voltmeter.* Reading should not exceed 30 volts.

(h) *Fuel Gage.* Must show correct amount of fuel in each of the four tanks.

(i) *Fire Detector Signal.* Operate test switch to determine whether fire detector system is working. Green light should go on if system is in satisfactory condition.

(j) *Engine Oil Level Gage.* Pointer should remain in the green sector. Should pointer indicate in the red sector, stop engine and investigate.

(k) *Engine Boil Signal.* This signal should light when temperature in the cooling system reaches 235 F. If signal lights, stop and investigate cause of overheating.

(7) **ITEM 36, GUNS AND MOUNTINGS, ELEVATING, TRAVERSING, AND FIRING CONTROLS.** While the vehicle is in operation, but before it is used in combat, check manual turret traversing controls and gun elevating, and firing controls to be sure that all mechanism responds properly.

## 21. AT-HALT SERVICE.

a. At-halt services may be regarded as minimum maintenance procedures and should be performed under all tactical conditions even though more extensive maintenance services must be slighted or omitted altogether.

b. **Procedures.** At-halt Services consist of investigating and deficiencies noted during operation, inspecting items listed below according to the procedures following the items, and correcting any

**3-INCH GUN MOTOR CARRIAGE M10A1**

deficiencies found. Deficiencies not corrected should be reported promptly to the designated individual in authority.

(1) **ITEM 39, TEMPERATURES (HUBS AND FINAL DRIVES).** Hand-feel the hubs of sprockets, idlers, bogie wheels, and track support rollers to determine whether or not they are abnormally hot.

(2) **ITEM 38, FUEL, OIL, AND WATER.** Determine quantity of fuel, oil, and water to make sure supply is adequate for mission. Add if necessary.

(3) **ITEM 45, TRACKS.** Remove stones and other material. Inspect tracks for correct tension, loose, worn or missing connectors and wedges and also worn, damaged, or dead blocks.

(4) **ITEM 42, SPRINGS AND SUSPENSIONS.** Examine suspensions for broken or loose parts. Remove any debris lodged in bogie assemblies.

(5) **ITEM 44, SPROCKET NUTS.** Examine sprocket cap screws and hub nuts to determine that they are present and secure.

(6) **ITEM 46, LEAKS, GENERAL.** Examine bottom of hull and ground under vehicle for evidence of any leaks. Inspect the hull, fighting compartment, and engine compartment for fuel, oil, or water leaks. Tighten any loose connections.

(7) **ITEM 50, TOWING CONNECTIONS.** Towing shackles, pins, and pintle hook must be in usable condition.

(8) **ITEM 47, ACCESSORIES AND BELTS.** Investigate possible causes of improper operation or performance noted during operation. Examine generators, starter, and water pump for security of mounting. Examine generator belts for good condition.

(9) **ITEM 48, AIR CLEANERS.** When operating under extremely dusty conditions, clean air cleaners as often as required when tactical situation permits. Examine filter elements. Clean and replace oil if necessary.

(10) **ITEM 52, APPEARANCE AND GLASS.** Thoroughly inspect exterior of vehicle for missing pioneer equipment. Inspect all lights and vision devices. Clean if necessary. See that all covers and hatches can be closed and locked securely.

**22. AFTER-OPERATION AND WEEKLY SERVICE.**

a. After-operation service is particularly important because at this time the driver inspects his vehicle to detect any deficiencies that may have developed, and corrects those he is permitted to handle. He should report promptly, to the designated individual in authority the results of his inspection. If this schedule is performed thoroughly, the vehicle should be ready to roll again on a moment's notice. The before-operation service, with a few exceptions, is then necessary only to ascertain whether the vehicle is in the same condition in which it was left upon completion of the after-operation service. The after-opera-

**PREVENTIVE MAINTENANCE INSPECTIONS AND SERVICE**

tion service should never be entirely omitted even in extreme tactical situations, but may be reduced to the bare fundamental services outlined for the at-halt service if necessary.

**b. Procedures.** When performing the after-operation service, the driver must remember and consider any irregularities noticed during the day in the before-operation, during-operation, and at-halt services. The after-operation service consists of inspecting and servicing the following items. Those items of the "after operation" that are marked by an asterisk (\*) require additional weekly services, the procedures for which are indicated in subparagraph (b) of each applicable item.

(1) **ITEM 55, ENGINE OPERATION.** Accelerate and decelerate the engine and note any tendency to miss or backfire, or any unusual noise or vibration that might indicate worn parts, loose mountings, incorrect fuel mixture, or faulty ignition. Report any unsatisfactory performance.

(2) **ITEM 56, INSTRUMENTS.** Examine for security of mounting and undamaged condition.

(3) **ITEM 70, STEERING LINKAGE.** Pull back steering levers to check free travel, which must be at least 4 inches. When travel is 8 inches, brakes must be adjusted.

(4) **ITEM 67, ENGINE CONTROLS.** Look for worn or disconnected engine control linkage. Investigate any improper action of control linkage noted during operation.

(5) **ITEM 57, SIREN.** Sound siren for proper tone if tactical situation permits.

(6) **ITEM 74, GEAR OIL LEVEL.** With vehicle on level ground, read oil level on transmission filler cap dip stick, and add oil if necessary to reach "FULL" mark.

(7) **ITEM 54, \*FUEL, OIL, AND WATER.**

(a) Fill all fuel tanks with fuel. Add oil to engine until gage reads "FULL." Do not overfill. Turn water expansion tank filler cap to first position to release pressure before removing cap. Before adding water, allow engine to cool if overheated. Have antifreeze tested if considerable water is added.

(b) *Weekly.* Have antifreeze tested to be sure protection is adequate for prevailing temperature.

(8) **ITEM 73, LEAKS, GENERAL.** Examine all fuel, oil, and water lines, pipes, connections, seals, gaskets, and tanks for leaks. Tighten loose connections and drain hull of any accumulated oil, water, or fuel.

(9) **ITEM 79, ARMOR.** Examine hull, turret, and gun mount shield for fractures or damage that would render vehicle unsafe for combat duty. All covers and hatches must operate freely and lock securely.

(10) **ITEM 68, \*TRACKS.**

(a) Remove all foreign matter such as mud, stones, and sticks from

**3-INCH GUN MOTOR CARRIAGE M10A1**

tracks. Look for loose and worn track connectors and wedges. Note if tracks have  $\frac{3}{4}$ -inch sag between upper track support rollers.

(b) *Weekly*. Tighten all track wedges securely. Examine tracks carefully for worn guides and blocks, also dead blocks. Adjust track tension so as to have  $\frac{3}{4}$ -inch sag between rear track support rollers.

**11. ITEM 69, \*SPRINGS AND SUSPENSIONS.**

(a) Examine the volute springs for abnormal sag and breakage. Volute springs are unserviceable when two or more coils contact lower spring seat. Look for looseness, wear, damage, and grease leaks of bogie frames, arms, and rollers. Remove all stones and trash lodged in bogie assemblies.

(b) *Weekly*. Tighten all bogie brackets, sprockets wheels, upper and lower rollers, mounting bolts and nuts, or cap screws.

(12) **ITEM 77, TOWING CONNECTIONS.** Examine towing shackles, pintle hook, and lifting eyes to see that they are in serviceable condition. Make sure pintle hook latch operates freely. Lubricate if necessary.

**(13) ITEM 64, \*ELECTRICAL WIRING.**

(a) Examine conduits for damaged condition and tighten all loose connections.

(b) *Weekly*. Clean all accessible wiring, looking for loose connections and cracked insulation.

**(14) ITEM 65, \*AIR CLEANERS AND BREATHER CAP.**

(a) Remove air cleaners and inspect elements and condition of oil. If necessary, clean elements and refill with oil to "LEVEL" mark on body. Examine condition of gaskets before installation.

(b) *Weekly*. Clean both air cleaners and breather cap and refill air cleaners with oil.

**(15) ITEM 66, \*FUEL FILTERS.**

(a) Remove plug and drain water and sediment.

(b) *Weekly*. Clean element and bowl.

(16) **ITEM 60, FIRE EXTINGUISHER.** Inspect portable fire extinguishers to see that they are in place, securely mounted, and that seals are not broken. See that red sealing caps on fixed fire extinguisher cylinder valves are intact. Discharged cylinders must be replaced. Make sure mountings are tight and nozzles are free from obstruction.

**(17) ITEM 62, \*BATTERY.**

(a) Battery connections and mountings must be kept clean and tight. Electrolyte must be one-fourth inch above plates in each cell. Add fresh clean water as required. Turn battery master switch and radio switch to "OFF" position after completing services.

(b) *Weekly*. Clean battery and terminal connections. Tighten connections and battery hold-downs if necessary.

**PREVENTIVE MAINTENANCE INSPECTIONS AND SERVICE**

(18) **ITEM 81, TURRET AND GUN MOUNT MECHANISM AND CONTROLS.** Release turret lock and gun traveling lock. Traverse turret full 360 degrees in both directions. Elevate and depress gun with hand mechanism. All mechanisms must operate freely and without bind or excessive play throughout entire limit of travel. Tighten all loose wiring connections and mountings. Test operation of firing controls and sighting equipment. Guns must be cleaned, properly oiled, and covered.

(19) **ITEM 59, LAMPS.** If tactical situation permits, turn all light switches to "ON" position, inspect all lights to see that they are operating properly, clean, and securely mounted and go out when switches are turned off.

(20) **ITEM 80, VISION DEVICES.** Clean and install serviceable periscope heads or assemblies as required. Mounts must pivot or rotate without binding.

(21) **ITEM 61, DECONTAMINATOR.** Must be fully charged and securely mounted. Shake to determine contents.

(22) **ITEM 84, CLEAN VEHICLE.** Remove all expended materiel and clean interior of vehicle thoroughly. Clean exterior as necessary, making sure identification markings are visible.

(23) **ITEM 83, \*LUBRICATE AS NEEDED.**

(a) Oil or lubricate all parts as required when performing after-operation service. For specific intervals and lubricants to be used, refer to War Department Lubrication Guides and section VI.

(b) *Weekly.* Perform regularly scheduled lubrication if this service is due.

(24) **ITEM 85, \*TOOLS AND EQUIPMENT.**

(a) Inspect all tools and equipment for condition, proper mounting, and serviceability using On Vehicle Materiel List. Replace missing items and replenish supplies.

(b) *Weekly.* Clean all tools and equipment. Replace items that are unserviceable.



3-INCH GUN MOTOR CARRIAGE M10A1

Section VI

LUBRICATION

	Paragraph
Introduction .....	23
Lubrication guide .....	24

23. INTRODUCTION.

a. **General.** The following lubrication instructions for 3-inch Gun Motor Carriage M10A1, are published for the information and guidance of the using arm personnel. Reference is made to OFSB 6-11 and OFSB 6-5 for lubrication and service below 0° F. In the field, it may not be possible to supply a complete assortment of lubricants called for by the lubrication guide to meet the recommendations. It will be necessary to make the best use of those available, subject to inspection of the officer concerned, in consultation with responsible ordnance personnel.

24. LUBRICATION GUIDE.

a. **Lubrication Instructions.** Lubrication instructions for all points to be serviced by the using arms are shown in War Department Lubrication Guide (figs. 13 and 14), which specifies the types of lubricants required and the intervals at which they are to be applied. Guides from which information is reproduced are 10- x 15-inch laminated charts which are part of the accessory equipment of each piece of materiel. Data contained in the lubrication guides are binding on using troops.

b. **Lubrication Notes.** The following notes apply to the lubrication guide (figs. 13 and 14). All note references in the guide itself are to the subparagraph below having the corresponding number. In addition to the items on the guide, other small moving parts, such as hinges and latches, must be lubricated at frequent intervals.

(1) **FITTINGS.** Clean before applying lubricant.

(a) *Motor Carriage.* Lubricate bogie wheels, idler and track support rollers, tachometer and speedometer adapters until lubricant overflows relief valve. Lubricate other fittings until new lubricant is forced from the bearing, unless otherwise specified.

(b) *Armament.* Where bearings can be seen, lubricate until new lubricant is forced from the bearing. **CAUTION:** Lubricate suspension points and armament fittings after washing vehicle.

(2) **INTERVALS.** Intervals indicated are for normal service. For extreme conditions of speed, heat, water, sand, mud, snow, dust, etc., reduce interval by one-third or one-half, or more, if conditions warrant.

LUBRICATION

CARRIAGE, MOTOR, GUN, 3-in., M10A1

MANUFACTURER'S SERIAL NUMBER located on name plate inside fighting compartment.

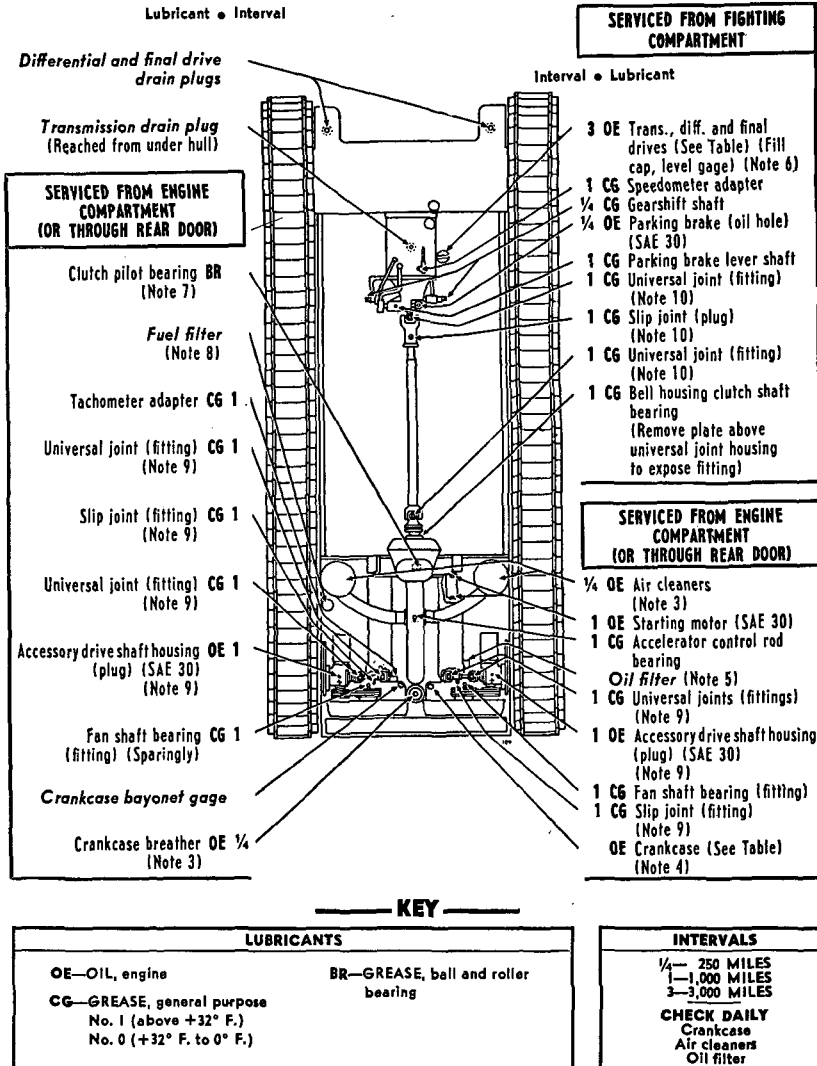


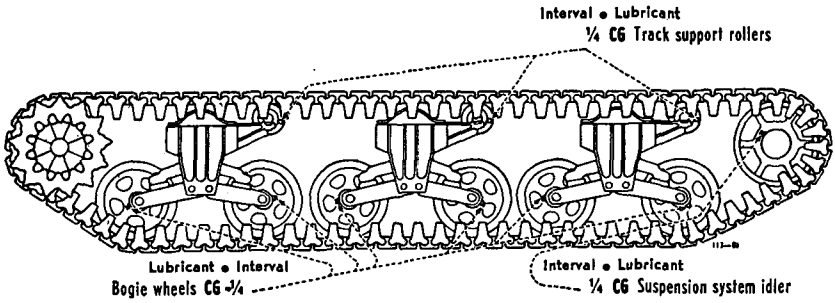
Figure 13—Lubrication Guide for Power Drive Units

3-INCH GUN MOTOR CARRIAGE M10A1

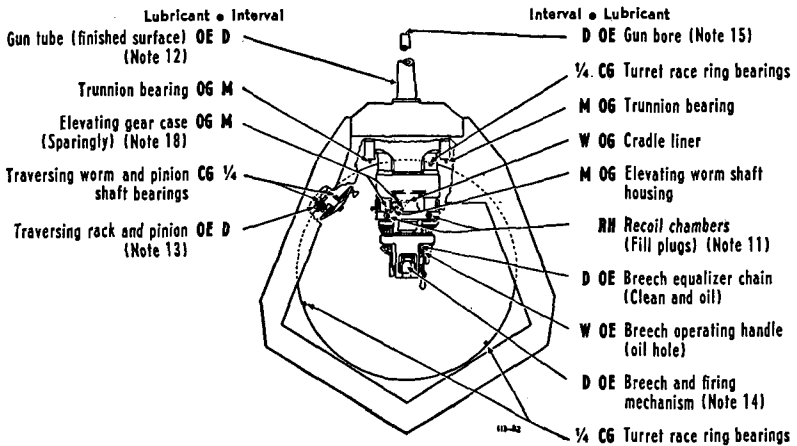
CARRIAGE, MOTOR, GUN, 3-in., M10A1

MANUFACTURER'S SERIAL NUMBER located on name plate inside fighting compartment.

**CAUTION** — Lubricate SUSPENSION SYSTEM POINTS on BOTH SIDES of MOTOR CARRIAGE



SUSPENSION SYSTEM



GUN, 3-in., M7; MOUNT,  
GUN, 3-in., M7

KEY

LUBRICANTS	
CG—GREASE, general purpose No. 1 (above +32° F.) No. 0 (+32° F. to 0° F.)	RH—OIL, recoil, heavy
OE—OIL, engine SAE 30 (above +32° F.) SAE 10 (+32° F. to 0° F.)	OG—GREASE, O.D. No. 0 (above +32° F.) No. 00 (below +32° F.)

INTERVALS
1/4—250 MILES
D—DAILY
W—WEEKLY
M—MONTHLY

TABLE OF CAPACITIES AND LUBRICANTS TO BE USED

OFSB 4-G-170 (104)

UNIT	CAPACITY (Approx.)	LOWEST EXPECTED AIR TEMPERATURE		
		+32° F. and above	+32° F. to 0° F.	Below 0° F.
Engine Crankcase	32 qt.	OE SAE 50	OE SAE 30	Refer to OFSB 6-11
Trans., Diff. and Final Drives	152 qt.			

RA PD 307527

Figure 14—Lubrication Guide for Suspension and Turret

## LUBRICATION

(3) **AIR CLEANERS.** Daily, when operating on dirt roads or cross country, or every 250 miles when operating on paved roads or during wet weather, drain, clean, and refill engine air cleaner with used crankcase oil or OIL, engine (crankcase grade). Every 100 to 500 miles, depending on operating conditions, remove air cleaner and wash all parts. **CAUTION:** Keep all air cleaner connections clean and tight. Every 100 to 500 miles, remove crankcase breather cap, wash in SOLVENT, dry-cleaning, and reoil with used crankcase oil or OIL, engine (seasonal grade). Proper maintenance of air cleaners is essential to prolonged engine life.

(4) **CRANKCASE.** Daily, check oil level; add oil if necessary. Every 500 miles or 50 hours, when operating on dirt roads or cross country, or every 1,000 miles when operating on paved roads or during wet weather, drain and refill. Drain only when engine is hot. Refill to "FULL" mark on bayonet gage, located on rear of engine on left side. **CAUTION:** Be sure pressure gage indicates oil is circulating. To avoid overfilling, allow engine to stand idle for several minutes before making final oil level check.

### (5) OIL FILTER.

(a) The oil filter is of the self-turning type and is located in the engine crankcase. Daily, check operation of self-turning mechanism. Weekly, remove filter element from housing, clean, and inspect.

(b) *Operation Check.* To check the operation of the filter, remove the manual turning nut, turn end for end, and attach; then run the engine at a speed which shows oil pressure at approximately 30 pounds. The manual turning nut will rotate slowly if the filter is operating. After the check is made, replace the manual turning nut in original position and secure with lock wire. If filter nut fails to turn, remove unit from engine for examination.

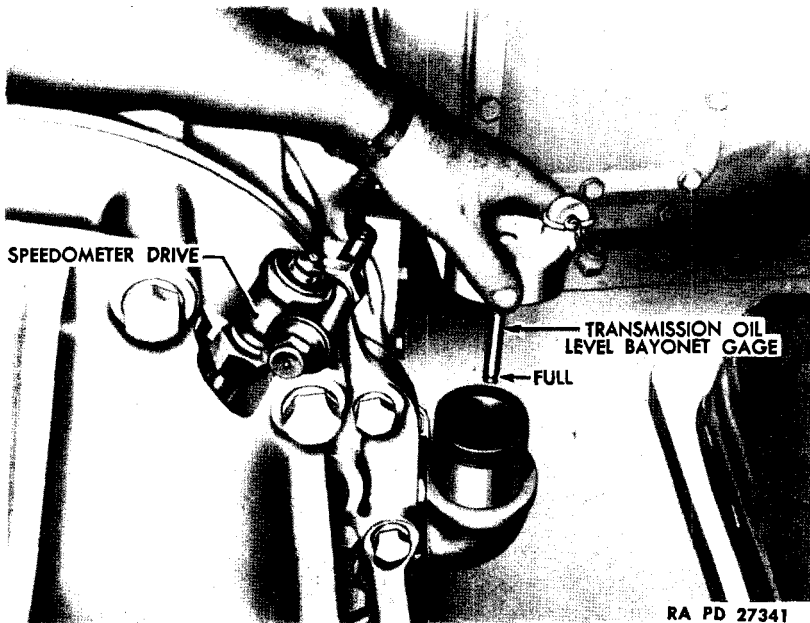
(c) *Servicing.* To remove the unit from the engine, remove engine compartment floor plate. Remove the six nuts securing the filter to the oil pan, and remove the filter unit.

(d) Clean the filter element by washing in SOLVENT, dry-cleaning, and turn the element by means of the manual turning nut while cleaning. *Do not blow air on the element.* Replace the filter by reversing sequence given in removal procedure.

### (6) GEAR CASES.

(a) Fill through transmission filler to mark on bayonet gage with filler cap resting on top of filler pipe (fig. 15). Drain through transmission and final drive drain plug holes. Weekly, check level with vehicle on level ground; if necessary, add lubricant to correct level. Drain, flush, and refill as indicated at points on guide. When draining, drain immediately after operation. Every 3,000 miles, clean transmission filler strainer. **CAUTION:** Do not remove strainer when filling.

## 3-INCH GUN MOTOR CARRIAGE M10A1



**Figure 15—Transmission Oil Bayonet Gage and Speedometer Drive**

(b) To flush, fill cases to about one-half capacity with OIL, engine, SAE 10. Operate mechanism within cases slowly for several minutes and redrain. Replace drain plug and refill cases to correct level with lubricant specified on guide.

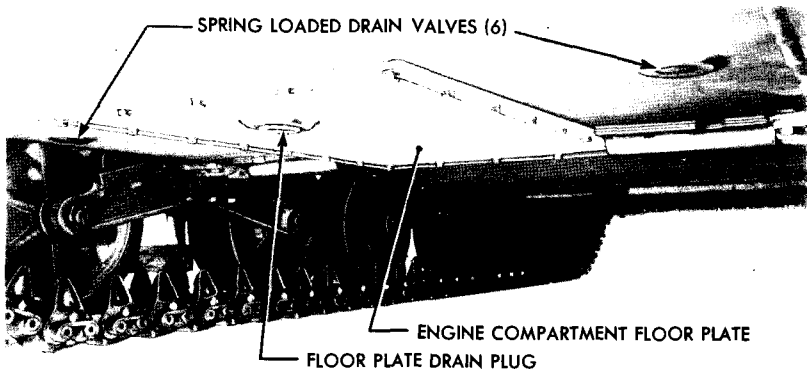
(7) **CLUTCH PILOT BEARING.** At time of disassembly of clutch for inspection, replacement, or overhaul, clean and repack bearing with GREASE, ball and roller bearing.

(8) **FUEL FILTER.** Daily, close all four fuel line shut-off valves, remove drain plug, and drain out sediment and water. Every 1,000 miles, remove element and wash in Diesel fuel or SOLVENT, dry-cleaning.

(9) **ACCESSORY DRIVE SHAFT HOUSINGS.**

(a) **Universal Joints and Slip Joints.** Filler plug in housing is fitted with bayonet gage; fill to "FULL" mark on gage. Lubricate universal joints through fittings with GREASE, general purpose (seasonal grade). There is no relief valve in these joints; do not use excessive pressure. To lubricate slip joints, apply GREASE, general purpose (seasonal grade), to fitting until lubricant is forced from end of spline.

## LUBRICATION



RA PD 27501

**Figure 16—Underside of Hull—From the Rear**

(10) **MOTOR CARRIAGE DRIVE UNIVERSAL JOINTS AND SLIP JOINT.** Remove tunnel shield sections over universal joints and slip joint at ends of tunnel shield. To lubricate slip joint, remove plug and insert fitting. Apply GREASE, general purpose (seasonal grade), to universal joints until it overflows at relief valve, and to slip joint until lubricant is forced from end of spline. CAUTION: After lubricating, remove fitting and replace plug in slip joint.

(11) **RECOIL FLUID.** Use OIL, recoil, heavy. Capacity is approximately 20 pints each cylinder. For instructions on handling of recoil fluid, refer to OFSB 6-6.

(12) **GUN TUBE.** Daily and before firing, clean and oil exposed finished metal surface. Keep surface covered with thin film of OIL, engine (seasonal grade).

(13) **TRAVERSING RACK AND PINION.** Daily, clean and apply OIL, engine (seasonal grade).

(14) **BREECH AND FIRING MECHANISM.** Daily and before and after firing, clean and oil all moving parts and exposed metal surfaces with OIL, engine (seasonal grade). CAUTION: To insure easy breech operation and to avoid misfiring in cold weather, clean with SOLVENT, dry-cleaning. Dry and lubricate with OIL, lubricating, preservative, light. To clean firing mechanism, remove and operate pin in SOLVENT, dry-cleaning.

(15) **GUN BORE.** Daily and after firing, clean and coat with OIL, engine (seasonal grade).

(16) **OILCAN POINTS.** Every 250 miles, lubricate steering and braking rod clevises and pins, spark and throttle rod end linkage, hinges, latches, elevating and traversing handwheel handles, traversing race

**3-INCH GUN MOTOR CARRIAGE M10A1**

ring and pinion, periscope holder pivots, etc., with OIL, engine (seasonal grade).

(17) **POINTS REQUIRING NO LUBRICATION SERVICE.** These points are: clutch release bearing, water pump, bogie wheel suspension linkage, final drive sprocket bearings.

(18) **POINTS TO BE SERVICED AND/OR LUBRICATED BY ORDNANCE MAINTENANCE PERSONNEL.** Generators, throttle control rod jackshaft, sight and gun rotor bearings, magnetos, elevating gear case (for disassembly and cleaning), and breech operating shaft bearings.

**c. Reports and Records.**

(1) **REPORTS.** If lubrication instructions are closely followed, proper lubricants used, and satisfactory results are not obtained, a report will be made to the ordnance officer responsible for the maintenance of the materiel.

(2) **RECORDS.** Record of seasonal changes of lubricants and recoil oil will be kept in the Artillery Gun Book.

Section VII

EQUIPMENT AND TOOLS ON VEHICLE

	Paragraph
Armament .....	25
Sighting equipment .....	26
Miscellaneous accessories and equipment .....	27
Signalling equipment .....	28
Rations .....	29
Vehicular tools and spare parts .....	30

25. ARMAMENT.

Item	Where Carried
<b>a. Accessories.</b>	
(1) 3-INCH GUN M7.	
Book, Artillery Gun, O.O. Form 5825 .....	Instruction bag
Brush, bore, M15 w/staff .....	Bracket on engine bulkhead
(consisting of	
Brush, bore, M15 B168031	
Staff, end B103377	
Staff, end B103378	
Staff, middle B124134)	
Can, ¼-gal (stencil "OIL RECOIL" in black letters ½ in. high on can)	
Case, carrying, gunner's quadrant, M1 .....	Bracket in turret
Cover, bore brush	
Cover, breech .....	On breech
Cover, muzzle .....	On gun
Extension, oil gun	
Gun, oil, recoil	
Oil, recoil, heavy, 1-qt (in can B101420)	
Quadrant, gunner's, M1 .....	Bracket in turret
Rammer, cleaning and unloading, M3	
Setter, fuse, M14 .....	Tool box under subfloor
Sight, bore	
Table, firing .....	Instruction bag
Table, range and elevation	
Target, testing (set of 4)	
(2) CAL. .50 MACHINE GUN.	
Bag, metallic belt link .....	Tool box under subfloor
Box, ammunition (50 rounds cal. .50) (6) .....	Bracket under subfloor
Brush, cleaning, cal. .50, M4 (4) .....	Tool box under subfloor
Case, cleaning rod, M15 .....	Tool box under subfloor
Chute, metallic belt link, M1 .....	Tool box under subfloor
Cover, gun and cradle, cal. .50 .....	On cal. .50 machine gun
Cover, mount tripod, M1	



**3-INCH GUN MOTOR CARRIAGE M10A1**

Item	Where Carried
Cover, spare barrel, M13, 45 in. ....	On spare barrel
Envelope, spare parts, M1 (w/o contents) (2) .....	Tool box under subfloor
Extractor, ruptured cartridge .....	Tool box under subfloor
Mount, tripod, cal. .50, M3	
Oiler, filling, oil buffer .....	Tool box under subfloor
Rod, cleaning, jointed, cal. .50, M7 .....	Tool box under subfloor
<b>(3) CAL. .45 SUBMACHINE GUN.</b>	
Brush, chamber cleaning, M6 .....	Tool Box
Brush, cleaning, cal. .45, M5 .....	Tool Box
Case, accessories and spare parts, M1918, w/o contents .....	Tool box
Cover, submachine gun bracket .....	Submachine gun bracket
Cover, Thompson submachine gun .....	On rack in turret
Envelope, fabric, one-button, 3- x 3½-in. ....	On rack in turret
Magazine, 30-round (clip) (20) or .....	Rack in turret
Magazine, 20-round (clip) .....	Rack in turret
Oiler, Thompson submachine gun .....	Tool box
Rod, cleaning .....	Tool box
Sling, gun, M1923 (webbing) .....	On cal. .45 submachine gun
Thong .....	Tool box

**h. Spare Parts.**

**(1) 3-INCH GUN M7.**

Fork, firing pin cocking .....	Tool box
Gasket, recoil cylinder filling plug (2) .....	Tool box
Percussion, assembly, consisting of:	
Guide, B163553 .....	Tool box
Pin, A25829	
Pin, straight, BFDX1BK	
Spring, A25835	
Stop, A25634	
Pin, cotter, 1/8- x 7/8-in. (2) .....	Tool box
Pin, firing .....	Tool Box
Plug, filling, recoil cylinder (2) .....	Tool box
Plunger, cocking fork .....	Tool box
Retainer, sear .....	Tool box
Spring, cocking fork plunger .....	Tool box
Spring, firing .....	Tool box
Spring, firing pin retracting .....	Tool box
Spring, sear .....	Tool box

**(2) CAL. .50 MACHINE GUN.**

Barrel, assembly .....	Tool box
Disk, buffer .....	Tool box
Extension, firing pin assembly .....	Tool box

**EQUIPMENT AND TOOLS ON VEHICLE**

Item	Where Carried
Extractor, assembly	Tool box
Lever, cocking	Tool box
Pin, cotter, belt feed lever pivot stud	Tool box
Pin, cotter, cover pin	Tool box
Pin, cotter, switch pivot (2)	Tool box
Pin, firing	Tool box
Plunger, belt feed lever	Tool box
Rod, driving spring w/spring assembly	Tool box
Slide, belt feed group	Tool box
Consisting of:	
Arm, belt feed pawl, B8914	
Pawl, feed belt, assy., B8961	
Pin, belt feed pawl, assy., B8962	
Slide, belt feed, assy., B261110	
Spring, belt feed pawl, A9351	
Slide, sear	Tool box
Spring, belt feed lever plunger	Tool box
Spring, belt holding pawl	Tool box
Spring, cover extractor	Tool box
Spring, locking barrel	Tool box
Spring, sear	Tool box
Stud, bolt	Tool box
(3) CAL. .45 MACHINE GUN.	
Disconnecter, 6D	Tool box
Ejector, 4B (M1928A1 only)	Tool box
Ejector, assembly (M1 only)	Tool box
Extractor, 15A	Tool box
Pin, firing, 14A	Tool box
Rocker, 16D	Tool box
Spring, disconnecter, 9A	Tool box
Spring, firing, 14C	Tool box
Spring, magazine catch, 9D	Tool box
Spring, recoil, 17C	Tool box
Spring, sear, 9B	Tool box
<b>c. Tools.</b>	
(1) 3-INCH GUN M7.	
Eyebolt, breech block, removing	Tool box
Mallet, rawhide, 230Z	Tool box
Tool, breech block removing	Tool box
(2) CAL. .50 MACHINE GUN.	
Wrench, combination, M2	Tool box
<b>d. Ammunition.</b>	
Cal. .30 rounds for model M1903 (60)	Bandolier, right front side plate

# TM 9-731G

25-27

## 3-INCH GUN MOTOR CARRIAGE M10A1

Item	Where Carried
Cal. .45 rounds (600)	Rack in turret
Cal. .50 rounds (300)	Boxes under subfloor
3-inch rounds (54)	48 rounds sponson, 6 rounds turret
90 percent A.P.	
10 percent H.E.	
Grenade, adapter	Under subfloor left front
Grenade, fragmentation (5)	Boxes in turret
Grenade, rifle (10)	Under subfloor left front
Grenade, smoke (5)	Boxes in turret
Grenade, thermite (2)	Boxes in turret

### e. Guns.

Gun, machine, cal. .50, H.B., M2	Mount in turret
Gun, Thompson, submachine, cal. .45, M1928A1	Rack in turret
Gun, 3-inch, M7	Mount in turret
Rifle, cal. .30, M1903	Left front side plate

## 26. SIGHTING EQUIPMENT.

Binocular, M3, complete, composed of:

Binocular, M3	In case
Case, carrying	Bracket in turret
Strap, neck	On case
Case, tube sight assembly	In bracket under gun
Mount, panoramic telescope, M39	On bracket in turret
Periscope, M6 (6)	In boxes by assistant driver (3 are spares)
Periscope, M6, extra heads (9)	In boxes by assistant driver
Telescope, M51 (2)	Bracket in turret (1 is a spare)
Telescope, panoramic, M12A4	In box on engine bulkhead
Tube, sight assembly	In bracket under gun

## 27. MISCELLANEOUS ACCESSORIES AND EQUIPMENT.

Apparatus, decontaminating 1½-qt, M2 (2)	Bracket under right rear subfloor
Bag, canvas, filed, O.D., M1936 (5)	Strap on to turret
Bag, tool	
Belt, safety (2)	On driver and assistant driver seat
Book, motor, for ordnance vehicles (O.O. Form 7255)	Instruction bag
Bucket, canvas, folding, 18-qt	Under left front subfloor
Bulb, lamp, inspection	Tool box
Cable, towing, 1½-in. x 20 ft	On upper hull
Canteen, M1910, with cup and cover, M1910 (5)	Brackets on right side plate
Container, water, 5-gal (QMC Standard) (2)	Brackets under subfloor
Extinguisher, fire, 4-lb CO <sub>2</sub> (2)	Bracket by driver, bracket in turret
Flashlight (5)	Bracket by assistant driver and driver

**EQUIPMENT AND TOOLS ON VEHICLE**

Item	Where Carried
Grouser (when track D48076 or D48067 is used) (26)	Bracket on rear of turret
Helmet, tank (sizes in accordance with QMC headsize chart) (5)	On men
Kit, first-aid (24-unit)	Bracket to left of driver
Lamp, inspection	Bracket to left of driver
Manual, field, for cal. .45 Submachine Gun M1928A1 (FM 23-40)	Instruction bag
Manual, field, for cal. .50 Machine Gun M2 (FM 23-65)	Instruction bag
Manual, field, for hand grenades (FM 23-30)	Instruction bag
Manual, spare parts, illustrated (for vehicle)	Instruction bag
Manual, technical, for 3-inch Gun M7	Instruction bag
Manual, technical, for 3-inch Gun Motor Carriage M10	Instruction bag
Manual, technical, for 3-inch Gun Motor Carriage M10A1	Instruction bag
Mittens, asbestos (2 pairs)	Behind cal. .45 submachine gun rack
Net, camouflage, cotton shrimp, 45- x 45-ft, Spec. T-1669	On Turret
Oiler (trigger type 1-pt)	Bracket under right front subfloor
Paulin, 12- x 12-ft	Bracket on turret
Roll, blanket (5)	On turret
Stove, cooking, gasoline, M1941, 1 burner	
consisting of:	Under subfloor
Coleman military burner No. 520 (with accessory cups)	
Strap, canvas, 1½- x 50-in. (4)	On turret
Tape, adhesive, 4-in. wide (O.D.) 15 yd long	Tool box
Tape, friction, ¾-in. wide, 30-ft roll	Tool box
Top, canvas, assembly	In place on turret
Tube, flexible, nozzle (2)	Tool box
War Department Lubrication Guide No. 113	Instruction bag
War Department Lubrication Guide No. 109	
Wire, soft iron, 14-Ga., 10-ft roll	Tool box

**28. SIGNALLING EQUIPMENT.**

Antenna, complete, w/cover (spare)	Depot
Flag set, M238, composed of:	Depot
Case, CS-90	
Flag, MC-273 (red)	
Flag, MC-274 (orange)	
Flag, MC-275 (green)	
Flagstaff, MC-270 (3)	
Interphone-System-RC-99	Depot

**TM 9-731G****28-30****3-INCH GUN MOTOR CARRIAGE M10A1**

Radio set, either SCR-510, SCR-610, or British 19 (1 per  
2 tanks) ..... Depot

**29. RATIONS.**

Item	Where Carried
Type "C" 2-day rations for 5 men (60 cans) .....	Ration box under right subfloor
Type "D" 1-day rations for 5 men (2 cans) .....	Ration box under right subfloor

**30. VEHICULAR TOOLS AND SPARE PARTS.****a. Spare Parts.**

Bulb, lamp, 3-cp, 24-28V (4) .....	Behind instrument panel
Bushing, rubber (4)	
Connector, end (12) .....	Tool box
Link (furnish link in accordance with track being used) (6) .....	On rear of turret
Nut, safety, 5/8-18NF-3 (16) .....	Tool box
Pin, cotter, 1/4- x 2 1/4-in. (for tow shackle pin) (2) .....	Tool box
Pin, locking (for tow shackle pin) (2) .....	Tool box
Solenoid, firing	
Switch, firing	
Wedge (12)	

**b. Tools.**

Adapter, button head to bayonet type .....	Tool bag
Adapter, button head to hydraulic type .....	Tool bag
Chisel, cold, 3/4-in. ....	Tool bag
Crossbar .....	Tool bag
Extension, handy grip, 1/2-in. sq-drive, 5-in. long .....	Tool bag
Extension, 1/2-in. drive, 10-in. long .....	Tool bag
File, hand, smooth, 8-in. ....	Tool bag
File, 3-square, smooth, 6-in. ....	Tool bag
Fixture, set, track connecting .....	Tool bag
Gun, grease, hand, type 1 .....	Tool bag
Hammer, machinist's, ball-peen, 32-oz .....	Tool bag
Handle, combination, T-, 1/2-in. sq-drive, 11-in. long .....	Tool bag
Handle, combination, T-, 3/4-in. sq-drive, 17-in. long .....	Tool bag
Handle, flexible, 1/2-in. sq-drive, 12-in. long .....	Tool bag
Handle, speeder, 1/2-in. sq-drive, 17-in. ....	Tool bag
Hose, lubricating, heavy-duty, 15-in., B.H. fitting .....	Tool bag
Joint, universal, 1/2-in. sq-drive .....	Tool bag
Pliers, combination, slip joint, 8-in. ....	Tool bag
Pliers, side cutting, 8-in. ....	Tool bag
Ratchet, reversible, 1/2-in. sq-drive, 9-in. ....	Tool bag
Screwdriver, machinist's, 5-in. blade .....	Tool bag

**EQUIPMENT AND TOOLS ON VEHICLE**

Screwdriver, special purpose, 1 <sup>3</sup> / <sub>4</sub> -in. blade	Tool bag
Screwdriver, special purpose, 1 <sup>1</sup> / <sub>2</sub> -in. blade	Tool bag
Wrench, adjustable, single-end, 8-in.	Tool bag
Wrench, adjustable, single-end, 12-in.	Tool bag
Wrench, engineer's, dble-hd, alloy-steel, <sup>5</sup> / <sub>16</sub> - x <sup>3</sup> / <sub>8</sub> -in.	Tool bag
Wrench, engineer's, dble-hd, alloy-steel, <sup>7</sup> / <sub>16</sub> - x <sup>1</sup> / <sub>2</sub> -in.	Tool bag
Wrench, engineer's, dble-hd, alloy-steel, <sup>9</sup> / <sub>16</sub> - x 1 <sup>1</sup> / <sub>16</sub> -in.	Tool bag
Wrench, engineer's, dble-hd, alloy-steel, <sup>5</sup> / <sub>8</sub> - x <sup>3</sup> / <sub>4</sub> -in.	Tool bag
Wrench, engineer's, dble-hd, alloy-steel, 1 <sup>3</sup> / <sub>16</sub> - x <sup>7</sup> / <sub>8</sub> -in.	Tool bag
Wrench, engineer's, dble-hd, alloy-steel, 1 <sup>5</sup> / <sub>16</sub> - x 1-in.	Tool bag
Wrench, plug, <sup>9</sup> / <sub>16</sub> -in. hex (transmission and oil drain plug)	Tool bag
Wrench, plug, <sup>3</sup> / <sub>4</sub> -in. hex (differential filler and drain plug)	Tool bag
Wrench, safety screw, <sup>3</sup> / <sub>32</sub> -in. hex	Tool bag
Wrench, safety screw, <sup>1</sup> / <sub>8</sub> -in. hex	Tool bag
Wrench, safety screw, <sup>3</sup> / <sub>16</sub> -in. hex	Tool bag
Wrench, safety screw, <sup>1</sup> / <sub>4</sub> -in. hex	Tool bag
Wrench, safety screw, <sup>5</sup> / <sub>16</sub> -in. hex	Tool bag
Wrench, safety screw, <sup>3</sup> / <sub>8</sub> -in. hex	Tool bag
Wrench, safety screw, <sup>5</sup> / <sub>8</sub> -in. hex	Tool bag
Wrench, socket, <sup>1</sup> / <sub>2</sub> -in. sq-drive, <sup>3</sup> / <sub>8</sub> -in. sq	Tool bag
Wrench, socket, <sup>1</sup> / <sub>2</sub> -in. sq-drive, <sup>7</sup> / <sub>16</sub> -in. hex	Tool bag
Wrench, socket, <sup>1</sup> / <sub>2</sub> -in. sq-drive, <sup>1</sup> / <sub>2</sub> -in. hex	Tool bag
Wrench, socket, <sup>1</sup> / <sub>2</sub> -in. sq-drive, <sup>9</sup> / <sub>16</sub> -in. hex	Tool bag
Wrench, socket, <sup>1</sup> / <sub>2</sub> -in. sq-drive, <sup>5</sup> / <sub>18</sub> -in. hex	Tool bag
Wrench, socket, <sup>1</sup> / <sub>2</sub> -in. sq-drive, <sup>3</sup> / <sub>4</sub> -in. hex	Tool bag
Wrench, socket, <sup>1</sup> / <sub>2</sub> -in. sq-drive, <sup>7</sup> / <sub>8</sub> -in. hex (2)	Tool bag
Wrench, socket, <sup>1</sup> / <sub>2</sub> -in. sq-drive, 1 <sup>5</sup> / <sub>16</sub> -in. hex (2)	Tool bag
Wrench, socket, <sup>1</sup> / <sub>2</sub> -in. sq-drive, 1-in. hex	Tool bag
Wrench, socket, <sup>1</sup> / <sub>2</sub> -in. sq-drive, 1 <sup>1</sup> / <sub>16</sub> -in. hex	Tool bag
Wrench, socket, <sup>1</sup> / <sub>2</sub> -in. sq-drive, 1 <sup>1</sup> / <sub>8</sub> -in. hex	Tool bag
Wrench, socket, <sup>3</sup> / <sub>4</sub> -in. sq-drive, 1 <sup>1</sup> / <sub>2</sub> -in. hex	Tool bag
Wrench, track adjusting	Tool bag

**c. Pioneer Tools.**

Axe (chopping, single-bitted 5-lb)	Bracket on rear plate
Crowbar, 5-ft, pinch point	Bracket on rear plate
Handle, mattock	Bracket on rear plate
Mattock, pick, M1 (without handle)	Bracket on rear plate
Shovel, short handled	Bracket on rear plate
Sledge, blacksmith, dble-face, 10-lb	Bracket on rear plate

**3-INCH GUN MOTOR CARRIAGE M10A1**

**PART TWO**

**VEHICLE MAINTENANCE INSTRUCTIONS**

**Section VIII**

**MAINTENANCE ALLOCATION**

	Paragraph
Scope .....	31
Allocation of maintenance .....	32

**31. SCOPE.**

a. The scope of maintenance and repair by the crew and other units of the using arms is determined by the availability of suitable tools, availability of necessary parts, capabilities of the mechanics, time available, and the tactical situation. All of these are variable and no exact system of procedure can be prescribed.

**32. ALLOCATION OF MAINTENANCE.**

a. Indicated below are the maintenance duties for which tools and parts have been provided for the using arm and ordnance maintenance personnel. Replacements and repairs which are the responsibility of ordnance maintenance personnel may be performed by using arm personnel when circumstances permit, within the discretion of the commander concerned. Echelons and words as used in this list of maintenance allocations are defined as follows:

**SECOND ECHELON:** Line organization regiments, battalions, companies, detachments, and separate companies (first and second echelons).

**THIRD ECHELON:** Ordnance light maintenance companies, ordnance medium maintenance companies, ordnance divisional maintenance battalions, and post ordnance shops.

**FOURTH ECHELON:** Ordnance heavy maintenance companies, and service command shops.

**FIFTH ECHELON:** Ordnance base regiments, ordnance bases, arsenals, and manufacturers' plants.

**SERVICE:**

(Including preventive maintenance) (par. 23 a (1) and (2), AR 850-15 (10-6-42))

Consists of servicing, cleaning, lubricating, tightening bolts and nuts, and making external adjustments of subassemblies or assemblies and controls.

**MAINTENANCE ALLOCATION**

**REPLACE:**

(par. 23 a (4), AR 850-15 (10-6-42)) Consists of removing the part, subassembly or assembly from the vehicles, and replacing it with a new or reconditioned or rebuilt part, subassembly or assembly, whichever the case may be.

**REPAIR:**

(par. 23 a (3) and (5), in part, AR 850-15 (10-6-42)) Consists of making repairs to, or replacement of the part, subassembly or assembly that can be accomplished without completely disassembling the subassembly or assemblies, and does not require heavy welding, or riveting, machining, fitting and/or alining or balancing.

**REBUILD:**

(par. 23 a (5), in part, and (6), AR 850-15 (10-6-42)) Consists of completely reconditioning and replacing in serviceable condition any unserviceable part, subassembly or assembly of the vehicle, including welding, riveting, machining, fitting, alining, balancing, assembling, and testing.

**NOTE:** Operations allocated will normally be performed in the echelon indicated by "X." Operations allocated to the echelons as indicated by "E" may be accomplished by the respective echelons in emergencies only.

	ECHELONS			
	2nd	3rd	4th	5th
<b>GENERAL INFORMATION ON MAINTENANCE</b>				
<b>BOXES AND RACKS, AMMUNITION</b>				
Boxes, ammunition—replace . . . . .	x			
Boxes, ammunition—repair . . . . .		x		
Racks, ammunition—replace . . . . .	x			
Racks, ammunition—repair . . . . .		x		
<b>CONTROLS, BRACKETS AND LEVERS</b>				
Brackets and levers—replace . . . . .	x			
Brackets and levers—repair . . . . .		x		
Controls and linkage (all)—service and/or replace . . . . .	x			
Controls and linkage (all)—repair . . . . .		x		
<b>COOLING GROUP</b>				
Connections, radiator to engine—replace . . . . .	x			
Fan assembly—replace . . . . .	x			
Fan assembly—repair . . . . .		x		
Fan assembly—rebuild . . . . .			x	
Radiator assemblies—replace . . . . .	x			
Radiator assemblies—repair . . . . .		x		
Radiator assemblies—rebuild . . . . .			E	x



3-INCH GUN MOTOR CARRIAGE M10A1

	2nd	ECHELONS		
		3rd	4th	5th
<b>COOLING GROUP—Cont'd</b>				
System, cooling—service . . . . .	X			
Tank, surge—replace . . . . .	X			
Tank, surge—repair . . . . .		X		
<b>DRIVE ASSEMBLY, GENERATOR AND FAN</b>				
Drive assemblies, generator and fan—replace . . . . .	X			
Drive assemblies, generator and fan—repair . . . . .		X		
Drive assemblies, generator and fan—rebuild . . . . .			X	
Shaft and universal joint assembly—replace . . . . .	X			
Shaft and universal joint assembly—repair . . . . .		X		
Shaft and universal joint assembly—rebuild . . . . .			E	X
<b>DRIVE, FINAL (GEAR TRAIN ASSEMBLY) (1-PIECE)</b>				
*Drive, final, gear train assembly—replace . . . . .		X		
Drive, final, gear train assembly—repair . . . . .		X		
Drive, final, gear train assembly—rebuild . . . . .			E	X
<b>DIFFERENTIAL AND SUBASSEMBLY, CONTROLLED</b>				
*Differential and subassembly, controlled— replace . . . . .		X		
Differential and subassembly, controlled—repair . . . . .		X		
Differential and subassembly, controlled—rebuild . . . . .			E	X
Drums, steering brake—replace and/or repair . . . . .		X		
Shoes, steering brake—service and/or replace . . . . .	X			
Shoes, steering brake—repair (reline) . . . . .		X		
<b>REDUCTION, FINAL</b>				
Hubs, sprocket—replace . . . . .	X			
Hubs, sprocket—repair . . . . .		X		
Hubs, sprocket—rebuild . . . . .			E	X
Reduction assembly, final drive—replace . . . . .	X			
Reduction assembly, final drive—repair . . . . .		X		
Reduction assembly, final drive—rebuild . . . . .			E	X
Sprockets—replace . . . . .	X			
Sprockets—rebuild . . . . .			E	X
<b>TRANSMISSION ASSEMBLY</b>				
Brake, parking—service and/or replace . . . . .	X			
Brake, parking—repair (reline) . . . . .		X		
*Transmission assembly—replace . . . . .		X		
Transmission assembly—repair . . . . .		X		
Transmission assembly—rebuild . . . . .			E	X

\*The second echelon is authorized to remove and reinstall items marked by an asterisk. However, when it is necessary to replace an item marked by an asterisk with a new or rebuilt part, subassembly or unit assembly, the assembly marked by an asterisk may be removed from the vehicle by the second echelon *only after authority has been obtained from a higher echelon of maintenance.*

**MAINTENANCE ALLOCATION**

**DRIVE, FINAL (GEAR TRAIN ASSEMBLY) (3-PIECE)**

	ECHELONS			
	2nd	3rd	4th	5th
*Drive, final, gear train assembly—replace . . . . .		X		
Drive, final, gear train assembly—repair . . . . .		X		
Drive, final, gear train assembly—rebuild . . . . .			E	X

**DIFFERENTIAL ASSEMBLY, CONTROLLED**

*Differential assembly, controlled—replace . . . . .		X		
Differential assembly, controlled—repair . . . . .		X		
Differential assembly, controlled—rebuild . . . . .			E	X

**DIFFERENTIAL SUBASSEMBLY, CONTROLLED**

*Differential subassembly, controlled—replace . . . . .		X		
Differential subassembly, controlled—repair . . . . .		X		
Differential subassembly, controlled—rebuild . . . . .			E	X
Drums, steering brake—replace and/or repair . . . . .		X		
Shoes, steering brake—service and/or replace . . . . .	X			
Shoes, steering brake—repair (reline) . . . . .		X		

**REDUCTION, FINAL**

Hubs, sprocket—replace . . . . .	X			
Hubs, sprocket—repair . . . . .		X		
Hubs, sprocket—rebuild . . . . .			E	X
Reduction assembly, final drive—replace . . . . .	X			
Reduction assembly, final drive—repair . . . . .		X		
Reduction assembly, final drive—rebuild . . . . .			E	X
Sprockets—replace . . . . .	X			
Sprockets—rebuild . . . . .			E	X

**TRANSMISSION ASSEMBLY**

Brake, parking—service and/or replace . . . . .	X			
Brake, parking—repair (reline) . . . . .		X		
*Transmission assembly—replace . . . . .		X		
Transmission assembly—repair . . . . .		X		
Transmission assembly—rebuild . . . . .			E	X

**ELECTRICAL GROUP**

Batteries—service, recharge, and/or replace . . . . .	X			
Batteries—repair . . . . .		X		
Batteries—rebuild . . . . .			E	X
Box, battery—replace . . . . .	X			
Box, battery—repair . . . . .		X		
Box, terminal—replace . . . . .	X			
Box, terminal—repair . . . . .		X		

\*The second echelon is authorized to remove and reinstall items marked by an asterisk. However, when it is necessary to replace an item marked by an asterisk with a new or rebuilt part, subassembly or unit assembly, the assembly marked by an asterisk may be removed from the vehicle by the second echelon only after authority has been obtained from a higher echelon of maintenance.

3-INCH GUN MOTOR CARRIAGE M10A1

	2nd	ECHELONS		
		3rd	4th	5th
<b>ELECTRICAL GROUP—Cont'd</b>				
Box, turret collector ring—replace	x			
Box, turret collector ring—repair		x		
Box, turret collector ring—rebuild			x	
Brackets, mounting and supports—replace	x			
Brackets, mounting and supports—repair		x		
Breakers, circuit—replace	x			
Breakers, circuit—repair		x		
Breakers, circuit—rebuild			x	
Cables, battery—replace	x			
Cables, battery—repair		x		
Conduit—replace	x			
Conduit—repair		x		
Filters—replace	x			
Filters—repair		x		
Generator assembly—replace	x			
Generator assembly—repair		x		
Generator assembly—rebuild			x	
Generator assembly, auxiliary—replace	x			
Generator assembly, auxiliary—repair		x		
Generator assembly, auxiliary—rebuild			E	x
Lamp assemblies (all)—service and/or replace	x			
Lamp assemblies (all)—repair		x		
Regulator, current and voltage—replace	x			
Regulator, current and voltage—service and/or repair		x		
Regulator, current and voltage—rebuild			x	
Siren—replace	x			
Siren—repair		x		
Siren—rebuild			x	
Solenoids—replace	x			
Solenoids—repair		x		
Switches—replace	x			
Switches—repair		x		
Switches—rebuild			x	
Units, signal sending—replace	x			
Units, signal sending—repair		x		
Wiring—replace	x			
Wiring—repair		x		
<b>ENGINE, FORD V8—MODEL GAA</b>				
Bearings, camshaft—replace			E	x
Bearings, connecting rod—replace		E	E	x
Bearings, crankshaft main—replace		E	E	x
Belts—service and/or replace	x			
Block, cylinder—rebuild (recondition)			E	x

MAINTENANCE ALLOCATION

ENGINE, FORD V8—MODEL GAA—Cont'd	ECHELONS			
	2nd	3rd	4th	5th
Brackets, engine mounting—replace	X			
Brackets, engine mounting—repair		X		
Carburetor assembly—service and/or replace	X			
Carburetor assembly—repair		X		
Carburetor assembly—rebuild			X	
Clutch assembly—replace	E	X		
Clutch assembly—repair		X		
Clutch assembly—rebuild			E	X
Crankshaft—rebuild (recondition)			E	X
Drive, tachometer—replace	X			
*Engine assembly—replace		X		
Engine assembly—repair		X		
Engine assembly—rebuild (recondition)			E	X
Filter, crankcase breather—replace	X			
Filter, crankcase breather—repair		X		
Filter, engine oil—replace	X			
Filter, engine oil—repair		X		
Gaskets, cylinder head and manifold—replace	X			
Governor assembly—service and/or replace		X		
Governor assembly—rebuild			E	X
Head assembly, cylinder and valve—repair and/or replace		X		
Head assembly, cylinder and valve—rebuild (recondition)			E	X
Housing, clutch—replace	E	X		
Housing, clutch—rebuild			X	
Lines, oil (external)—replace	X			
Lines, oil (external)—repair		X		
Lines, oil (internal)—replace and/or repair		X		
Magneto assemblies—replace	X			
Magneto assemblies—repair		X		
Magneto assemblies—rebuild			X	
Manifolds, intake, exhaust and water—replace	X			
Manifolds, intake, exhaust and water—repair		X		
Motor assembly, starting—replace	X			
Motor assembly, starting—repair		X		
Motor assembly, starting—rebuild			X	
Pan assembly, oil—service and/or replace gasket		X		
Pan assembly, oil—replace and/or repair		X		
Pistons and rings—replace		E	E	X

\*The second echelon is authorized to remove and reinstall items marked by an asterisk. However, when it is necessary to replace an item marked by an asterisk with a new or rebuilt part, subassembly or unit assembly, the assembly marked by an asterisk may be removed from the vehicle by the second echelon only after authority has been obtained from a higher echelon of maintenance.

3-INCH GUN MOTOR CARRIAGE M10A1

	2nd	ECHELONS		
		3rd	4th	5th
<b>ENGINE, FORD V8—MODEL GAA—Cont'd</b>				
Plugs, spark—service and/or replace	x			
Plugs, spark (2-piece)—repair		x		
Pulleys, accessory drive—replace	x			
Pump assembly, fuel—service and/or replace	x			
Pump assembly, fuel—repair		x		
Pump assembly, fuel—rebuild			x	
Pump assembly, oil—replace and/or repair		x		
Pump assembly, oil—rebuild			x	
Pump assembly, water—replace	x			
Pump assembly, water—repair		x		
Pump assembly, water—rebuild			x	
Rods, connecting—replace		E	E	x
Screen assembly—replace	x			
Units, signal sending, oil and water—replace	x			
Valves—service	x			
Wiring and conduit assembly, ignition—replace	x			
Wiring and conduit assembly, ignition—repair		x		
<b>FIRE EXTINGUISHING SYSTEM</b>				
Control, remote—replace	x			
Control, remote—repair		x		
Cylinder, CO <sub>2</sub> —replace	x			
Cylinder, CO <sub>2</sub> —repair and/or recharge		x		
Extinguisher assemblies, fire, CO <sub>2</sub> —repair and/or recharge		x		
Extinguisher assemblies, fire, CO <sub>2</sub> —rebuild			E	x
Lines and nozzles—replace	x			
Lines and nozzles—repair		x		
<b>FUEL GROUP</b>				
Cleaners, air—service and/or replace	x			
Cleaners, air—repair		x		
Filter—service and/or replace	x			
Filter—repair		x		
Lines, valves and fittings—replace	x			
Lines, valves and fittings—repair		x		
Pump, priming—replace	x			
Pump, priming—repair		x		
Pump, priming—rebuild			x	
Tanks, fuel—service and/or replace	x			
Tanks, fuel—repair		x		
<b>HULL</b>				
Brackets, engine support—replace			E	x
Doors and cover plates—replace	x			
Doors and cover plates—repair		x		

**MAINTENANCE ALLOCATION**

	HULL—Cont'd	ECHELONS			
		2nd	3rd	4th	5th
Guards, mud—replace		X			
Guards, mud—repair			X		
Housing, propeller shaft—replace		X			
Housing, propeller shaft—repair			X		
Hull—repair			X		
Hull—rebuild				E	X
Insulation and padding—replace		X			
Periscope—replace		X			
Periscope—repair			X		
Periscope—rebuild				E	X
Pintle assembly—replace		X			
Pintle assembly—repair			X		
Pintle assembly—rebuild				X	
Seats—replace		X			
Seats—repair			X		
Subfloor—replace		X			
Subfloor—repair			X		
<b>INSTRUMENTS AND PANELS</b>					
Instruments—replace		X			
Instruments—repair			X		
Instruments—rebuild				E	X
Panels and connections—replace		X			
Panels and connections—repair			X		
<b>LUBRICATION GROUP</b>					
Cooler, transmission oil—replace		X			
Cooler, transmission oil—repair			X		
Cooler, transmission oil—rebuild				E	X
Filter, engine oil—replace		X			
Filter, engine oil—repair			X		
Lines, oil, engine and transmission—replace		X			
Lines, oil, engine and transmission—repair			X		
<b>SHAFT, PROPELLER</b>					
Shaft assembly, propeller, w/universal joints— replace		X			
Shaft assembly, propeller, w/universal joints— repair			X		
Shaft assembly, propeller, w/universal joints— rebuild				E	X
<b>TRACK SUSPENSION GROUP</b>					
Bearings and seals, bogie and idler wheels—replace		X			
Bogie components—replace		X			
Bogie components—repair			X		

3-INCH GUN MOTOR CARRIAGE M10A1

TRACK SUSPENSION GROUP—Cont'd	ECHELONS			
	2nd	3rd	4th	5th
Bogie components—rebuild			E	X
Bracket, idler—replace	E	X		
Bracket, idler—repair		X		
Bracket, idler—rebuild			E	X
Roller and bracket assembly, track supporting—replace	X			
Roller and bracket assembly, track supporting—repair		X		
Roller and bracket assembly, track supporting—rebuild			E	X
Track assembly—replace and/or repair	X			
Track assembly—rebuild			E	X
Wheels, bogie—replace	X			
Wheels, bogie—repair (replace tire)		X		
Wheels, idler—replace	X			
Wheels, idler—repair		X		
Wheels, idler—rebuild			E	X
<b>TURRET</b>				
Brake assembly—replace	X			
Brake assembly—repair		X		
Mechanism, turret traversing—replace	X			
Mechanism, turret traversing—repair		X		
Mechanism, turret traversing—rebuild			X	
Ring, turret—replace		X		
Turret assembly—replace and/or repair		X		
Turret assembly—rebuild			E	X
<b>VEHICLE ASSEMBLY</b>				
Carriage, motor, 3-inch gun, M10A1—service and preventive maintenance	X			
Carriage, motor, 3-inch gun, M10A1—rebuild (with serviceable unit assemblies)			X	E

Section IX

ORGANIZATION PREVENTIVE MAINTENANCE SERVICES

	Paragraph
Second echelon preventive maintenance services . . . . .	33

**33. SECOND ECHELON PREVENTIVE MAINTENANCE SERVICES.**

a. Regular scheduled maintenance inspections and services are a preventive maintenance function of the using arms, and are the responsibility of commanders of operating organizations.

(1) **FREQUENCY.** The frequencies of the preventive maintenance services outlined herein are considered a minimum requirement for normal operation of vehicles. Under unusual operating conditions such as extreme temperatures, dusty or sandy terrain, it may be necessary to perform certain maintenance services more frequently.

(2) **FIRST ECHELON PARTICIPATION.** The drivers should accompany their vehicles and assist the mechanics while periodic second echelon preventive maintenance services are performed. Ordinarily the driver should present the vehicle for a scheduled preventive maintenance service in a reasonably clean condition; that is, it should be dry and not caked with mud or grease to such an extent that inspection and servicing will be seriously hampered. However, the vehicle should not be washed or wiped thoroughly clean, since certain types of defects, such as cracks, leaks and loose or shifted parts or assemblies, are more evident if the surfaces are slightly soiled or dusty.

(3) If instructions other than those contained in the general procedures in step (4) below, or the specific procedures in paragraph (5) which follow, are required for the correct performance of a preventive maintenance service or for correction of a deficiency, other sections of the vehicle operator's manual pertaining to the item involved, or a designated individual in authority, should be consulted.

(4) **GENERAL PROCEDURES.** These general procedures are basic instructions which are to be followed when performing the services on the items listed in the specific procedures. **NOTE:** The second echelon personnel must be thoroughly trained in these procedures so that they will apply them automatically.

(a) When new or overhauled subassemblies are installed to correct deficiencies, care should be taken to see that they are clean, correctly installed, properly lubricated, and adjusted.

(b) When installing new lubricant retainer seals, a coating of the



**3-INCH GUN MOTOR CARRIAGE M10A1**

lubricant should be wiped over the sealing surface of the lip of the seal. When the new seal is a leather seal, it should be soaked in SAE No. 10 engine oil (warm if practicable) for at least 30 minutes. The leather lip should be worked carefully by hand before installing the seal. The lip must not be scratched or marred.

(c) The general inspection of each item applies also to any supporting member or connection, and usually includes a check to see whether the item is in good condition, correctly assembled, secure, or excessively worn. The mechanics must be thoroughly trained in the following explanations of these terms.

1. The inspection for "good condition" is usually an external visual inspection to determine whether the unit is damaged beyond safe or serviceable limits. The term "good condition" is explained further by the following terms: Not bent or twisted, not chafed or burned, not broken or cracked, not bare or frayed, not dented or collapsed, not torn or cut.

2. The inspection of a unit to see that it is "correctly assembled" is usually an external visual inspection to see whether it is in its normal assembled position in the vehicle.

3. The inspection of a unit to determine if it is "secure" is usually an external visual examination, a hand-feel, or a pry-bar check for looseness. Such an inspection should include any brackets, lock washers, lock nuts, locking wires, or cotter pins used in assembly.

4. "Excessively worn" will be understood to mean worn, close to or beyond serviceable limits, and likely to result in a failure if not replaced before the next scheduled inspection.

(d) *Special Services.* These are indicated by repeating the item numbers in the columns which show the interval at which the services are to be performed, and show that the parts or assemblies are to receive certain mandatory services. For example, an item number in one or both columns opposite a *Tighten* procedure, means that the actual tightening of the object must be performed. The special services include:

1. *Adjust.* Make all necessary adjustments in accordance with the pertinent section of the vehicle operator's manual, special bulletins, or other current directives.

2. Clean units of the vehicle with dry-cleaning solvent to remove excess lubricant, dirt, and other foreign material. After the parts are cleaned, rinse them in clean fluid and dry them thoroughly. Take care to keep the parts clean until reassembled, and be certain to keep clean-

## ORGANIZATION PREVENTIVE MAINTENANCE SERVICES

ing fluid away from rubber or other material which it will damage. Clean the protective grease coating from new parts, since this material is not a good lubricant.

3. *Special lubrication.* This applies either to lubrication operations that do not appear on the vehicle lubrication chart and to items that do appear on such charts but should be performed in connection with the maintenance operations if parts have to be disassembled for inspection or service.

4. *Serve.* This usually consists of performing special operations, such as replenishing battery water, draining and refilling units with oil, and changing the oil filter cartridge.

5. *Tighten.* All tightening operations should be performed with sufficient wrench torque (force on the wrench handle) to tighten the unit according to good mechanical practice. Use torque-indicating wrench where specified. Do not overtighten, as this may strip threads or cause distortion. Tightening will always be understood to include the correct installation of lock washers, lock nuts, and cotter pins provided to secure the tightening.

(e) When conditions make it difficult to perform the complete preventive maintenance procedure at one time, they can sometimes be handled in sections, planning to complete all operations within the week if possible. All available time at halts and in bivouac areas must be utilized if necessary to assure that maintenance operations are completed. When limited by the tactical situation, items with Special Services in the column should be given first consideration.

(f) The numbers of the preventive maintenance procedures that follow are identical with those outlined on W.D. A.G.O. Form No. 462, which is the Preventive Maintenance Service Work Sheet for Full Track and Tank-like Wheeled Vehicles. Certain items on the work sheet that do not apply to this vehicle are not included in the procedures in this manual. In general, the numerical sequence of items on the work sheet is followed, in the manual procedures, but in some instances there is deviation for conservation of the mechanic's time and effort.

(5) The procedures for performing each item in the 50-hour (500 miles) and 100-hour (1,000 miles) maintenance procedures are described in the following chart. Each page of the chart has two columns at its left edge corresponding to the 100-hour and the 50-hour maintenance, respectively. Very often it will be found that a particular procedure does not apply to both maintenances. In order to determine which procedure to follow, look down the column corresponding to the maintenance due, and wherever an item number appears, perform the operations indicated opposite the number.

**3-INCH GUN MOTOR CARRIAGE M10A1**

**ROAD TEST**

NOTE: If the tactical situation does not permit a full road test, perform items 2, 3, 5, 6, 9, 12, 13, 14, and 15 which require slight or no movement of the vehicle. When a road test is possible, it should be, preferably, for 3 miles but not over 5 miles.

Maintenance 100-Hour	Maintenance 50-Hour	
1	1	<b>BEFORE OPERATION INSPECTION.</b> Before vehicle is road tested, perform those before-operation services, paragraph 19, necessary to determine whether the vehicle is in satisfactory condition to be road tested.
2	2	<p><b>INSTRUMENTS AND GAGES.</b></p> <p><i>Oil Pressure Gages.</i> Engine oil pressure must read at least 11 pounds when engine is idling and 60 to 80 pounds at 2,600 revolutions per minute. Stop engine immediately when red indicator light comes on.</p> <p><i>Ammeter.</i> Ammeter will show a high charging rate for first few minutes. A high charging rate for extended period with all electrical units turned off indicates a discharged battery or faulty regulator.</p> <p><i>Voltmeter.</i> Voltmeter must not read more than 30 volts when regulator operates properly.</p> <p><i>Speedometer.</i> Speedometer must register correct speed and accumulated mileage without noise.</p> <p><i>Tachometer.</i> The tachometer must register accumulated crankshaft revolutions.</p> <p><i>Engine Temperature Gage.</i> The gage should not exceed 235 F nor fall below 90 F plus atmospheric temperature.</p> <p><i>Transmission Oil Temperature Gage.</i> Oil gage should not exceed 200 F.</p> <p><i>Fuel Gage.</i> Fuel gage must register approximate amount of fuel in tanks.</p> <p><i>Clock.</i> The clock must be wound, running, and indicate correct time.</p>
3	3	<b>SIREN.</b> Sound siren for proper tone if tactical situation permits.
5	5	<b>BRAKES.</b> Apply both steering brakes at slow speed to test effectiveness. Free travel must be 4 to 8 inches. Test each brake for effective steering with moderate

**ORGANIZATION PREVENTIVE MAINTENANCE SERVICES**

Maintenance 100-Hour	Maintenance 50-Hour	
		application. Stop vehicle and apply parking brake. When steering levers are used as parking brake, pedal lock must securely hold levers in applied position and release freely. When transmission parking brake is used, lever must move freely and remain locked in fully applied position.
6	6	<b>CLUTCH.</b> Test free travel of pedal which must be 3½ inches. Clutch must fully release and must not slip or chatter. Listen for noisy release bearing.
7	7	<b>TRANSMISSION.</b> Shift through entire gear range. Lever and safety button must operate freely, gears must shift smoothly, operate quietly, and not slip out of mesh. Note any unusual noise, clashing, or hard shifting.
9	9	<b>ENGINE.</b> Engine must run smoothly and quietly at idle speed of 500 to 600 revolutions per minute. Gradually increase speed to maximum governed speed of 2,600 revolutions per minute, noting any misfiring, detonation, unusual noises, or excessive smoking. When driving vehicle, observe power and acceleration.
10	10	<b>UNUSUAL NOISE.</b> During road test listen for any unusual noise or vibration that would indicate loose, worn or defective units, or lack of lubrication.
11	11	<b>TEMPERATURES.</b> Stop vehicle and feel bogie wheel and roller, and idler wheel bearings for overheating.
12	12	<b>GUN ELEVATING, TRAVERSING, AND STABILIZER MECHANISM.</b> Release turret lock and gun travelling lock. Traverse turret full 360 degrees. Elevate and depress gun with hand mechanism. All mechanism must operate freely without binding or excessive play throughout entire travel. Secure gun travelling lock and turret lock.
13	13	<b>LEAKS.</b> Stop vehicle with engine running and thoroughly examine bottom of hull and ground under vehicle for evidence of any leaks. Inspect hull and engine compartment for fuel, oil, or water leaks.
15	15	<b>TRACK TENSION.</b> Track must not bind nor whip. Proper tension is ¾-inch sag between support rollers.

3-INCH GUN MOTOR CARRIAGE M10A1

Maintenance 100-Hour	Maintenance 50-Hour	
		<b>MAINTENANCE OPERATIONS</b>
17	17	<b>CRANKCASE.</b> Stop engine and open battery master switch. Remove engine access plate. Inspect oil pan, engine, and connections for leaks. Drain oil pan and refill if this service is due or oil is contaminated. When oil is drained, do not install new oil until item 54 is completed.
54	54	<b>ENGINE OIL FILTER.</b> Inspect engine oil filter for loose mounting bolts and leaks. Remove and thoroughly clean element and install new gasket.
18	18	<b>SIDE ARMOR.</b> Examine front, rear and side armor, and plates for fractures or damage that would render vehicle unsafe for combat duty. Inspect towing shackles, lifting eyes, and pintle hook. Make sure pintle hook latch operates freely. Inspect fenders, exhaust deflectors, and light guards for bent or damaged condition. Identification markings must be visible. Paint and camouflage must meet the requirements of the tactical situation. Tighten loose mountings and straighten bent parts. Lubricate towing shackles, pintle hook, and latch.
19	19	<b>BOTTOM ARMOR.</b> Examine bottom of hull to determine whether it is in serviceable condition. Examine inspection plate and drain valves to make sure they are properly sealed and securely mounted. Release escape hatch must operate freely and lock securely. Tighten engine inspection plate securely. Lubricate escape hatch lock mechanism.
20	20	<b>DIFFERENTIAL AND FINAL DRIVES.</b> Examine housings for fractures, leaks, or loose attaching bolts. Drain differential and/or final drive housings when transmission oil is to be changed. See item 78.
20		<i>Tighten.</i> All mounting and attaching bolts should be tightened securely.
21	21	<b>TRACKS.</b> Examine tracks for loose, worn, or missing connectors and wedges; also for worn, damaged, or dead blocks. Inspect tracks for proper tension. Tighten all wedge nuts securely. Replace unserviceable blocks, connectors, or wedges. Adjust track so that it is not too tight and does not sag more than three-fourths inch between support rollers.

**ORGANIZATION PREVENTIVE MAINTENANCE SERVICES**

Maintenance 100-Hour	Maintenance 50-Hour	
21		<i>*Serve.</i> Remove tracks on each third 100-hour maintenance service (par. 129). Thoroughly inspect all parts covered in items 21, 22, 23, 24, and 25.
22	22	<b>IDLERS.</b> Examine bracket for fracture or loose or missing attaching bolts. Spindle clamp and locking collar must be securely locked. Inspect idler wheel for damage, bearing, or bearing seal failure, missing lubrication fittings, or loose bearing cap. Tighten all attaching bolts, spindle clamp bolts, bearing cap bolts, and locking collar.
22		<i>*Bearings.</i> Bearings must be thoroughly tested for failure, excessive wear, or looseness by using pry bar on wheel when track is removed at every third 100-hour preventive maintenance service.
23	23	<b>BOGIES.</b> Examine bogie bracket for fractures or loose mounting. Inspect bogie arms, levers, gudgeons, spring seats, and rubbing plates for fractures, excessive wear, or looseness. Volute springs are unserviceable if two or more coils contact lower spring seat.
23		<i>Tighten.</i> All assembly and mounting bolts must be tightened securely.
24	24	<b>BOGIE WHEELS AND ROLLERS.</b> Inspect bogie wheels for broken hubs, grease leaks, and missing lubrication fittings. Inspect rollers for loose mountings, breaks, or missing lubrication fittings. Inspect track skids for loose mountings or excessive wear. Examine all bogie wheel tires for scoring, excessive wear, or blow-outs. Raise bogie wheels using bogie lift (par. 128). Rotate wheel to detect worn, broken, or inadequately lubricated bearings and test for end play. Track must be connected when making this test.
24		<i>*Serve.</i> Raise tracks free of support rollers. Rotate rollers to detect worn, broken, or inadequately lubricated bearings and test for end play. Make this test before track is connected at each third 100-hour preventive maintenance service. Tighten all assembly and mounting bolts securely.

## 3-INCH GUN MOTOR CARRIAGE M10A1

Maintenance 100-Hour	Maintenance 50-Hour	
25	25	<b>SPROCKETS.</b> Examine sprockets for fractures, excessively worn or broken teeth, or loose attaching bolts. Inspect hub for grease leaks, loose attaching bolts, or fractures. Tighten all attaching bolts securely.
25		* <b>Serve.</b> Remove track at each third 100-hour preventive maintenance service (par. 129). Test track drive sprocket shaft bearings for excessive wear, end play, or failure, by working hub with pry bar. Reverse or replace worn or damaged sprockets.
27	27	<b>TOP ARMOR.</b> Examine all top hull and turret armor for fractures or damage that would render vehicle unsafe for combat duty. All covers, grilles, and hatches must open freely and lock securely.
28	28	<b>FILLER COVERS AND CAPS.</b> All filler cap covers must open and close freely and have lock pin attached to chain. Examine all filler caps for crossed threads, leaking gaskets or plugged vents.
30		<b>ENGINE REMOVAL.</b> When condition indicates engine is no longer serviceable and specific orders are given by a higher echelon, the engine may be removed according to procedure given in paragraph 37 b.
43	43	<b>AIR CLEANERS.</b> Remove air cleaners and disassemble. Inspect all gaskets and seals for serviceability and bodies for evidence of leaks. Clean elements and thoroughly dry. Clean oil reservoir and refill with seasonal grade engine oil to "FULL" mark on body.
44	44	<b>CARBURETORS.</b> Inspect to see that they are securely mounted, not leaking, and that all linkage and springs are properly connected.
46	46	<b>CYLINDER HEADS AND GASKETS.</b> Examine cylinder heads for cracks, oil, water, or compression leaks around studs or gaskets. Cylinder heads will not be tightened unless there is definite evidence of looseness or leaks. Tighten cylinder heads or replace gaskets as needed.
31		<b>VALVE MECHANISM.</b> Remove camshaft housings and examine camshafts and push rods for good condition

**ORGANIZATION PREVENTIVE MAINTENANCE SERVICES**

Maintenance 100-Hour	Maintenance 50-Hour	
		and adequate lubrication. Valve clearance is not adjusted by the using arms. Inspect cover gasket for serviceability.
32		<b>SPARK PLUGS.</b> Remove all plugs and examine electrodes for pitting, burning, and gap setting of 0.011 inch to 0.014 inch. After cleaning, replace any spark plug that is unserviceable or requires gap adjustment.
33		<b>COMPRESSION TEST.</b> Test engine compression in each cylinder. Readings for all eight cylinders must not be below 155 pounds. Record readings in space provided on War Department Form No. 462. Normal compression is 155 to 180 pounds at cranking speed. Cylinders showing above 180 pounds indicate an excessive amount of carbon. Variation of 15 pounds between cylinders is permissible.
34	34	<b>GENERATORS AND STARTER.</b> Examine generators and starter for loose mounting bolts or loose electrical connections.
34		<i>Clean.</i> Remove generator cover band and inspect for worn brushes, brush spring tension, dirty or scored commutator. Clean commutator if required. Tighten all mounting bolts and electrical connections.
37	37	<b>MAGNETOS.</b> Examine for security of mounting and good condition. Note whether there is any evidence of oil leaks at mounting pads. Breaker point gap must be 0.016 inch. The points must be free from oil or grease and be in proper alinement. Pitted points must be replaced.
45	45	<b>MANIFOLDS.</b> Examine exhaust manifold, intake housing for loose mounting bolts or gasket leaks.
49	49	<b>WATER PUMP, FANS, AND SHROUDS.</b> Examine water pump, gaskets, and connections for loose mounting bolts and leaks. Inspect fans and shrouds for alinement and loose attaching bolts. Tighten bolts and replace gaskets as needed.



3-INCH GUN MOTOR CARRIAGE M10A1

Maintenance 100-Hour	Maintenance 50-Hour	
53	53	<b>FUEL TANKS AND PUMP.</b> Make sure fuel tanks, valves, lines, tubes, and connections are tight and securely mounted. Inspect these items for leaks. Examine fuel pump for loose mountings or leaking gaskets. Replace gaskets and tighten as necessary.
53		<i>Fuel Tanks and Pump.</i> Drain tanks to remove any sediment or water.
55	55	<b>FUEL FILTER.</b> Inspect filter for loose mounting and leaks. Clean the filter element and bowl. Replace gaskets and tighten loose mountings and connections as required.
57	57	<b>EXHAUST PIPES.</b> Inspect exhaust pipes to see that all connections are tight; that there are no leaks; and that units are securely mounted.
58	58	<b>ENGINE MOUNTINGS.</b> Inspect all engine mountings for looseness and tighten if required.
48	48	<b>CLUTCH ASSEMBLY.</b> Examine clutch housing for loose mountings and cracks. Examine all linkage for presence of cotter keys and return spring. Free travel must be 3½ inches.
51	51	<b>ENGINE COMPARTMENT.</b> Inspect engine compartment and all controls and linkage, making sure they are clean and in serviceable condition.
51		<i>Clean.</i> Clean engine compartment thoroughly and when engine is removed, repaint if necessary.
60	60	<b>FIXED FIRE EXTINGUISHER SYSTEM.</b> Examine all lines, connections, nozzles, and controls to see that they are tight and securely mounted. Nozzles must be intact and free from obstructions. Cylinders must be removed and weighed to make sure they are fully charged. Operate remote controls with cylinders removed to see that they have sufficient travel and work freely. Lubricate pulleys, cables, and mechanisms as needed.
61	61	<b>ENGINE INSTALLATION.</b> When the engine is removed at specific order given by a higher echelon, it must be installed according to procedures given in paragraph

**ORGANIZATION PREVENTIVE MAINTENANCE SERVICES**

Maintenance 100-Hour	Maintenance 50-Hour	
		37 b. Make certain all fuel, oil, water lines, and various controls are securely tightened and radiator and crankcase are filled before starting engine.
62	62	<b>RADIATOR.</b> Examine all water tubes, hoses, and connections to see that they are tight and securely mounted. Examine radiator core to see there are no leaks. Examine water for contamination, rust, or scale. Remove all accumulated dirt from radiator cooling surfaces. Test antifreeze to make sure protection is adequate for prevailing temperatures and record in space provided on War Department Form No. 462.
63	63	<b>BATTERIES.</b> Clean and dry exterior of batteries and inspect for cracks and leaks. Clean, tighten, and grease terminals. Make sure all electrical connections and battery clamps are tight. Take hydrometer reading of each cell. Normal reading is 1.275. Report reading if 1.225 or less. Make high rate discharge test on each cell. Report differences of more than 30 percent between cells. Record hydrometer and discharge readings in space provided on War Department Form 462. Add clean water to each cell as required to raise level of electrolyte to one-fourth inch above top of plates. Battery cover must be securely fastened.
64	64	<b>ACCELERATOR.</b> Make sure accelerator pedal and linkage has all cotter pins in place, is securely mounted and lubricated, and operates throughout full limit of travel without binding.
65	65	<b>STARTER.</b> Operate starter to make sure it engages freely and develops adequate cranking speed without unusual noise or grind.
66	66	<b>LEAKS.</b> Inspect all units serviced in the engine compartment for evidence of any fuel, oil, or water leaks while the engine is running. Tighten if required. Replace gaskets and other parts if necessary.
68	68	<b>GENERATOR REGULATORS.</b> Inspect mountings and electrical connections to see that they are tight. Regulators must be properly grounded.

3-INCH GUN MOTOR CARRIAGE M10A1

Maintenance 100-Hour	Maintenance 50-Hour	
68		Serve. Make voltage and amperage tests using low voltage tester to determine proper functioning of all regulators.
69		ENGINE IDLE. Run engine at idling speed. Tachometer must read 500 revolutions per minute. Listen to exhaust for indication of misfiring or uneven operation. Adjust idle as required.
70	70	THROTTLE SYNCHRONIZATION. The throttle connecting rod must be adjusted so that with engine stopped both throttles are against the stops on both carburetor adapters. Adjust and tighten linkage as necessary (par. 56).
71	71	FIGHTING COMPARTMENT. Inspect fighting compartment making sure it is clean and free from expended materiel and that painted surfaces are in good condition and clean. All fighting compartment stowage boxes, racks, brackets, and equipment must be in proper place, in serviceable condition, and securely mounted.
56	56	TRANSMISSION OIL COOLER. Inspect lines, hoses, connections, and core for leaks and loose mountings. Air-cooling fins must be kept clean.
72	72	TURRET. Platform doors must open freely and lock securely. All seats must operate freely and lock in position.
86	86	ELECTRICAL WIRING. Inspect all wiring, conduits, terminal boxes, and electrical connections. They must be tight, securely mounted, and in serviceable condition. See that all circuit breakers are closed.
		<b>ARMAMENT</b>
126	126	GUNS. The turret must operate through entire 360 degrees without bind or excessive backlash. Hand brake must operate effectively. Elevate and depress gun by hand mechanism. It must operate freely without bind or excessive backlash under positive control throughout entire limit of travel. Both manual and electrical firing controls must operate with positive action and all connections and mountings must be tightened securely.

## ORGANIZATION PREVENTIVE MAINTENANCE SERVICES

Maintenance 100-Hour	Maintenance 50-Hour	
128	128	<b>A. A. GUN MOUNT.</b> Install gun mount in turret bracket. Mount must move freely in all directions without binding. Lubricate as required.
129	129	<b>SPARE GUN BARRELS AND PARTS.</b> Inspect spare gun barrel to see that it is serviceable and properly stowed. Replace all expended armament spare parts.
84	84	<b>COMPASS.</b> Inspect compass to see that it is securely mounted, contains sufficient fluid, and is in serviceable condition.
73	73	<b>PERISCOPES.</b> All mounts must pivot or rotate freely without binding. All serviceable periscopes must be cleaned and expended units or heads replaced.
74	74	<b>CLUTCH PEDAL.</b> Clutch pedal height must be 16 inches, measured vertically, from top edge of pedal pad to driver's seat floor plate. Free pedal travel must be 3½ inches. Slowly depress pedal to see that there is no binding in linkage.
75	75	<b>BRAKES.</b> Steering brake levers must have 4 to 8 inches free travel and be parallel as shoes contact drums. When steering levers are used as parking brake, pedal lock must securely hold levers in applied position and release freely. When transmission parking brake is used, lever must move freely and remain locked in fully applied position. Adjust and tighten linkage as required. Replace brake shoes when road test or inspection reveals either the steering or parking brake lining is no longer serviceable (par. 123 e and par. 124 b).
77	77	<b>DIFFERENTIAL AND BREATHER.</b> Inspect all differential seals and gaskets in driver's compartment for evidence of leaking. Examine all mounting bolts for looseness. Tighten as necessary. Breather must not be clogged. Remove breather and clean.
78	78	<b>TRANSMISSION AND BREATHER.</b> Inspect all transmission seals and gaskets for evidence of leaking. Examine all attaching bolts for looseness. Tighten when necessary. Breather must not be clogged. Remove breather and clean.

3-INCH GUN MOTOR CARRIAGE M10A1

Maintenance 100-Hour	Maintenance 50-Hour	
80	80	TRANSMISSION CONTROLS. Examine for worn or loose linkage. Safety button must operate freely without binding. Tighten and lubricate when necessary.
81	81	PROPELLER SHAFT. Test propeller shaft for run-out and inspect welds. Inspect universal joint flange bolts for looseness. Inspect universal joints for wear and grease leaks. Tighten bolts and lubricate when necessary. Housing bolts must be tight and covers securely fastened.
85	85	LIGHTS AND SWITCHES. With all light switches in "ON" position, inspect all lights to see that they are operating properly, clean and securely mounted, and go out when switches are turned off. Inspect all switches, making sure all connections and mountings are tightened securely.
<b>TOOLS AND EQUIPMENT</b>		
130	130	TOOLS AND EQUIPMENT. Inspect all tools and equipment to make certain they are in serviceable condition and properly stowed in quantities shown on the current, "On Vehicle Materiel List."
134	134	DECONTAMINATOR. Shake to see that it is full and look at date on tag to see that charge is not more than 90 days old. Recharge if required. Fasten securely in place.
135	135	PORTABLE FIRE EXTINGUISHERS. Remove and weigh extinguishers to make sure they are fully charged (par. 138). Replace with fully charged units if necessary. Fasten securely in place.
136	136	PUBLICATIONS AND FORM NO. 26. See that the "On Vehicle Materiel List" and all publications and forms listed therein and Standard Accident Form No. 26 are legible and properly stowed.
137	137	VEHICLE LUBRICATION. Check lubrication of entire vehicle. On any unit where disassembly was necessary for inspection purposes, lubrication must be performed

**ORGANIZATION PREVENTIVE MAINTENANCE SERVICES**

Maintenance 50-Hour	Maintenance 100-Hour	
		<p>unless the vehicle is to be deadlined for repair of that unit. Lubricate all points of vehicle in accordance with instructions in this manual, War Department Lubrication Guide (figs. 13 and 14), current lubrication bulletins, or directives, and the following instructions: Use only clean lubricant and keep all lubricant containers covered; before applying lubricant, clean lubrication fitting or plug; replace missing or damaged fittings, lines, plugs, or vents. On unsealed bushings or joints, the lubricant should be applied until it appears at openings. On units provided with lubricant retainer seals, do not force excess lubricant past seals. Drain oil from engine, oil tanks, oil pump, transmission, transfer case, differential, and final drives while warm. Refill units to correct level as soon as draining is completed so units will not be operated without lubricant. The "COLD" oil level, as marked on the oil level indicator in transmission, is the level desired and if conditions make it necessary to check the level when hot with oil foaming, level may be above level line marked "HOT." Do not apply more than specified amount of lubricant to generator or starter. To do so, may cause a failure of the unit. Wipe off excess lubricant that may soil clothes and equipment, or detract from the vehicle's appearance. Parts or assemblies that have been lubricated while disassembled for inspection, gear cases that have been drained and refilled as mandatory items in the procedures, and those parts that have been indicated in the procedures for special lubrication may be omitted from the general lubrication of the vehicle.</p>
138	138	<p><b>MODIFICATION.</b> The organizational records must be reviewed to make certain that all Field Service Modification Work Orders pertaining to the vehicle have been completed.</p>
139	139	<p><b>FINAL ROAD TEST.</b> Repeat items 2 to 15 inclusive, paying particular attention to those units on which work has been performed to make certain they have been restored to first-class operating condition. Correct any deficiencies found during the final road test.</p>

3-INCH GUN MOTOR CARRIAGE M10A1

Section X

ORGANIZATIONAL TOOLS AND EQUIPMENT

	Paragraph
Allocation of tools and equipment . . . . .	34

34. ALLOCATION OF TOOLS AND EQUIPMENT.

a. The tools and equipment included in this section, together with the vehicular tools listed in section VII, provide the using arms with necessary tools and equipment for servicing the vehicle.

b. Organization Maintenance Tools, Standard Sets.

Standard Tool Sets	Federal Stock Number
Tool-set, motor vehicle mechanics' . . . . .	41-T-3538
Tool-set, blacksmiths' No. 2 . . . . .	41-T-3515
Tool-set, pioneer equipment, motor vehicle Set No. 1 . . . . .	41-T-3539-5
Tool-set, welders' . . . . .	41-T-3555
Tool-set, unit equipment, second echelon Set No. 1 . . . . .	41-T-3545-10
Tool-set, unit equipment, second echelon Set No. 2 . . . . .	41-T-3545-11
Tool-set, unit equipment, second echelon Set No. 3 . . . . .	41-T-3545-12
Tool-set, unit equipment, second echelon Set No. 4 . . . . .	41-T-3545-13
Tool-set, unit equipment, second echelon Set No. 5 . . . . .	41-T-3545-14
Tool-set, unit equipment, second echelon Set No. 6 . . . . .	41-T-3545-15
Tool-set, unit equipment, second echelon Set No. 7 . . . . .	41-T-3545-16
Tool-set, unit equipment, second echelon Set No. 9 . . . . .	41-T-3545-18

**ORGANIZATIONAL TOOLS AND EQUIPMENT**

**c. Organization Special Tools.**

Name	Mfrs. Symbol	Mfrs. Tool No.	Federal Stock Number	Vehicle Set	Mech. Set	Company Set	Bn. or Regt. Crew Set	Regt. or Bn. Maint. Plat. Set
Adapter, overhaul stand, use stand 15035	WKR	T 61	41-A-18-100					2
Bolt, eye lifting, engine compartment top plate	MTM	M3-497	41-B-1586-200			4	2	4
Bolt, eye, 1-8NC-2 transmission lifting			41-B-1586-350					4
Compressor, suspension volute spring	MTM	M3-3				2	2	2
Drift, bogie wheel, bearing	MTM	M3-13	41-D-1463			1	1	1
Drift, idler wheel inner bearing, use with W/MTM-M3-8 puller	MTM	M3-41				1	1	1
Drift, idler wheel inner bearing	MTM	M3-15	41-D-1540-500			1	1	1
Drift, idler wheel outer bearing	MTM	M3-14	41-D-1540-550			1	1	1
Fixture, track connecting with simplex jack	TK	7278	41-F-2997-85	1		1	1	1
Gage, pair brake linkage, adjusting	MTM	M3-158			1	1	1	1
Guide, bogie wheel gudgeon, installing	MTM	M3-5	41-G-2500			1	1	1
Handle, socket wrench, spark plug	WKR	T-5	41-H-1507-50		1	1	1	1
Indicator, top dead center and timer	WKR	T 77	41-I-115				1	1
Lift, bogie wheel, medium tank	MTM	M3-813	41-L-1375			1	1	1
Plate, timing, magneto driven gear shaft holder and indexing	WKR	T 51	41-P-1567-300				1	1
Protector, bogie wheel gudgeon, driving	MTM	M3-133	41-P-2838			1	1	1
Puller, bogie gudgeon screw type with adapter A161884	MTM	M3-6A	41-P-2905-65					1
Puller, idler wheel	MTM	M3-8	41-P-2940-800			1	1	1
Puller, idler wheel outer bearing	MTM	M3-40				1	1	1



3-INCH GUN MOTOR CARRIAGE M10A1

Name	Mfrs. Symbol	Mfrs. Tool No.	Federal Stock Number	Vehicle Set	Mech. Set	Company Set	Bn. or Regt. Crew Set	Regt. or Bn. Maint. Plat. Set
Puller, slide hammer type, bogie gudgeon			41-P-2957-33			1	1	1
Remover, dowel, clutch and flywheel alinement	WKR	T 58	41-R-2377					1
Remover, flange clutch and engine turner	WKR	T 14	41-R-2380-500				1	1
Replacer, clutch pilot bearing	WKR	T 78	41-R-2391-36				1	1
Screwdriver, special, adjusting	WKR	T 59	41-S-1652-500			1	1	1
Sling, engine	WKR	T 68	41-S-3831					2
Sling, final drive and transmission	MTM	M3-136	41-S-3832-72					4
Socket, screwdriver, 1/2-in. square drive (for 1/2-in. armor plate bolts)			41-S-3867-150		1	2		2
Socket, screwdriver, 1/2-in. square drive (for 3/4-in. armor plate bolts)			41-S-3867-157		1	2		2
Stand, engine, overhaul	STY	15035	41-S-4942-14					2
Tool, clutch, disk alining	WKR	T 3	41-T-3083-75				1	1
Tool, idler wheel installing	MTM	M3-9	41-T-3216-150			1	1	1
Wrench, box socket, suspension, spring compressor, special, 1 1/2-in. hexagon	MTM	M3-2A	41-W-640-200			1	1	1
Wrench, box, 3-in. hexagon, 44 5/8 in. long	MTM	M3-7	41-W-640-400			1	1	1
Wrench, cylinder head nut, long	WKR	T 9	41-W-866-200			1	1	1
Wrench, cylinder head nut, short	WKR	T 29	41-W-866-250			1	1	1
Wrench, drain plug, final drive, differential, 3/4-in. hexagon	MTM	M3-130	41-W-877	1	1	1	1	1
Wrench, arain plug, transmission	MTM	M3-131	41-W-878	1	1	1	1	1
Wrench, open end, special timing, 3/4-in.	WKR	T 69	41-W-1578-500				1	1
Wrench, plug, male, 5/8-in. hexagon	MTM	M3-10	41-W-1960		1	1	1	1

**ORGANIZATIONAL TOOLS AND EQUIPMENT**

Name	Mfrs. Symbol	Mfrs. Tool No.	Federal Stock Number	Vehicle Set	Mech. Set	Company Set	Bn. or Regt. Crew Set	Regt. or Bn. Maint. Plat. Set
Wrench, socket, bogie wheel gudgeon nut, 2 <sup>3</sup> / <sub>8</sub> -in. hexagon	MTM	M3-137	41-W-2573-150			1	1	1
Wrench, socket, idler wheel shaft lock nut	MTM	M3-21				1	1	1
Wrench, socket, spark plug, Ford GAA engine	WKR	T 5	41-W-3336-300		1	1	1	1
Wrench, socket, special clutch, mainshaft nut, 2 <sup>1</sup> / <sub>8</sub> -in.	WKR	T 17	41-W-2964-248				1	1
Wrench, spanner, track support roller lock ring	MTM	M3-19	41-W-3260			1	1	1
Wrench, spanner, track support roller retainer	MTM	M3-11	41-W-3261			1	1	1
Wrench, spanner, special lock, magneto driven gear to cross shaft	WKR	T 36	41-W-3255-550				1	1

3-INCH GUN MOTOR CARRIAGE M10A1

Section XI

ENGINE

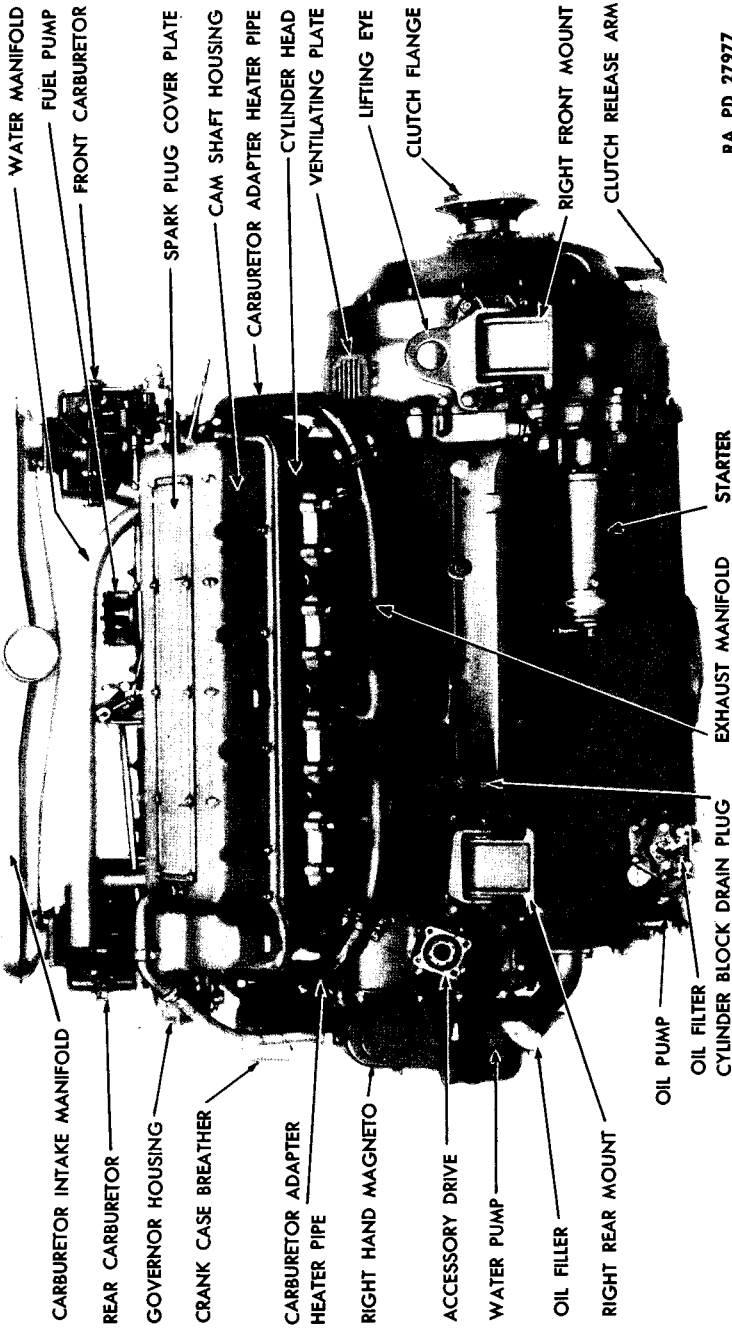
	Paragraph
General description and data .....	35
Engine trouble shooting .....	36
Engine replacement .....	37
Engine mounts .....	38
Governor .....	39
Valve mechanism .....	40
Manifolds .....	41
Oil pump .....	42
Oil filter .....	43
Crankcase breather .....	44

35. GENERAL DESCRIPTION AND DATA.

a. **Description.** This vehicle is powered with a 60-degree, V, 8-cylinder, 4-cycle, valve-in-head, liquid-cooled Ford tank engine. The cylinder block and crankcase are cast enblock of aluminum with steel, dry-type, sleeves in cylinder bores. The water jackets extend the full length of cylinders. Four overhead camshafts are used, one exhaust and one intake for each bank of cylinders. There are two exhaust and two intake valves in each cylinder. The engine is mounted at the rear of the vehicle and supported by four brackets. The two front brackets are mounted on the engine compartment bulkhead. The two rear brackets are mounted on the engine compartment floor. Rubber mounts are used between the brackets and the engine. Two 4-cylinder magnetos are used. These are located at the rear of the engine (fig. 19), one mounted at each end of a cross shaft driven by gears. The water pump (fig. 19), is driven from the end of the crankshaft. Two accessory drive housings located on the side walls of the engine compartment are each driven through an accessory drive shaft and universal joints by the accessory drive gears in the engine. Two pusher-type fans are driven through double V-type belts by the accessory drives (par. 66). The generators are mounted on the forward end of the accessory drive housings (par. 72). The oil pump (par. 42) is of the gear type.

b. **Definition of Terms.** The flywheel end of engine will be referred to as the "front" of the engine as the engine is mounted in the vehicle with the flywheel forward. The terms "right" and "left" are used with reference to the engine as viewed from the rear looking toward front of the vehicle.

ENGINE



RA PD 27977

Figure 17 — Engine — Right Side

**3-INCH GUN MOTOR CARRIAGE M10A1**

c. **Tabulated Data.** The following data includes the general information and engine characteristics which are frequently required for reference:

**General:**

Make and type	Ford V-type, 8-cylinder, tank engine
Model	GAA
Over-all dimensions (including clutch)	{ 59.02 inches long 33.25 inches wide 47.78 inches high
Weight (including all parts listed in paragraph 45 d)	1,470 lb
Horsepower	500 at 2,600 rpm
Torque	1,050 lb at 2,200 rpm
Number of cylinders	8
Bore	5.4 in.
Stroke	6 in.
Piston displacement	1,100 cu in.
Compression ratio	7.5 to 1

**Directions or rotation (viewed from rear of engine):**

Crankshaft	Clockwise
Starter	Counterclockwise
Magnetos (right-hand rotor)	Clockwise
(left-hand rotor)	Counterclockwise

**Accessory speeds:**

Fan	1.4 crankshaft speed
Tachometer	1/2 crankshaft speed
Generator	1.75 crankshaft speed
Magneto rotor	1/2 crankshaft speed

**Magneto:**

Make and model	Bosch MJF4A307-308
Breaker point gap	0.014 in.-0.16 in.
Spark plug gap	0.011 in.-0.014 in.
Valve clearance (nonadjustable)	0.027 in.-0.30 in.
Carburetor—Make and model (2 used)	Bendix-Stromberg NA-Y5G

**Numbering of cylinders from rear to front:**

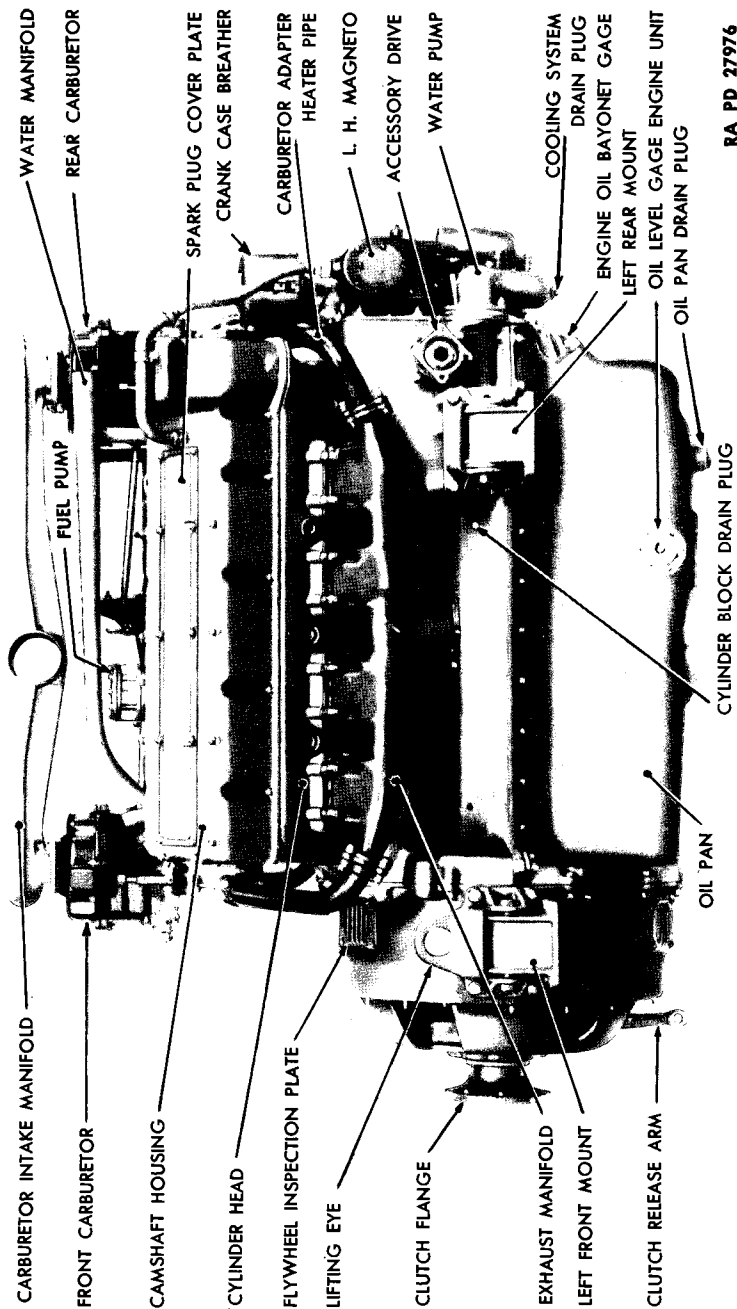
Right bank	1-2-3-4
Left bank	1-2-3-4

**Firing order:** 1-R, 2-L, 3-R, 1-L, 4-R, 3-L, 2-R, 4-L

**36. ENGINE TROUBLE SHOOTING.**

a. **General.** Difficulty in determining the exact cause of engine trouble will be encountered at times because of the number of sources

ENGINE



RA PD 27976

Figure 18—Engine—Left Side

**3-INCH GUN MOTOR CARRIAGE M10A1**

to which a given symptom may be attributed. The best method of trouble shooting is to consider the possible causes and eliminate them, one by one, starting with the most probable cause. The purpose of this is to minimize, in so far as possible, the time wasted in ascertaining the source of a given trouble.

**b. Voltmeter Reading Remains Unchanged and the Engine Fails to Turn Over When the Starter Button Is Pressed.**

<b>Possible Cause</b>	<b>Possible Remedy</b>
Battery master switch off.	Turn master switch on.
Starter button circuit incomplete.	Tighten connections and repair or replace wires.
Starter button defective.	Replace (par. 88).
Circuit to starter incomplete.	Tighten connections and repair cable.
Battery not grounded.	Clean and tighten connections.
Open circuit in starter.	Replace (par. 78 b).

**c. Voltmeter Reading Drops to Low Limit and the Engine Fails to Turn Over when the Starter Button Is Pressed.**

Battery is undercharged.	Recharge or replace (par. 76 d) and correct cause.
Starter is shorted.	Replace starter (par. 78 b).
Starter circuit is shorted.	Repair or replace cable.

**d. Starter Runs but Engine Fails to Turn Over when Starter Button Is Pressed.**

Starter drive faulty.	Replace.
Starter gear on flywheel faulty.	Notify ordnance maintenance personnel.

**e. Engine Turns Over but Does Not Start.**

Ignition switch "OFF."	Turn "ON."
Fuel shut-off valves closed.	Open valves.
Fuel tank empty.	Refill tank.
Engine flooded (overpriming).	Place throttle in wide open position and turn engine over with the starter five or six revolutions.
Insufficient priming.	Reprime the engine with two or three additional strokes.
Magneto ground wires shorted.	Replace.
No fuel in carburetor bowl.	(Par. 36 f.)
No spark at spark plugs.	(Par. 36 g.)
Ignition switch faulty.	Replace (par. 48).
Ignition timing (engine backfires but does not start).	Time ignition (par. 46 c).

ENGINE

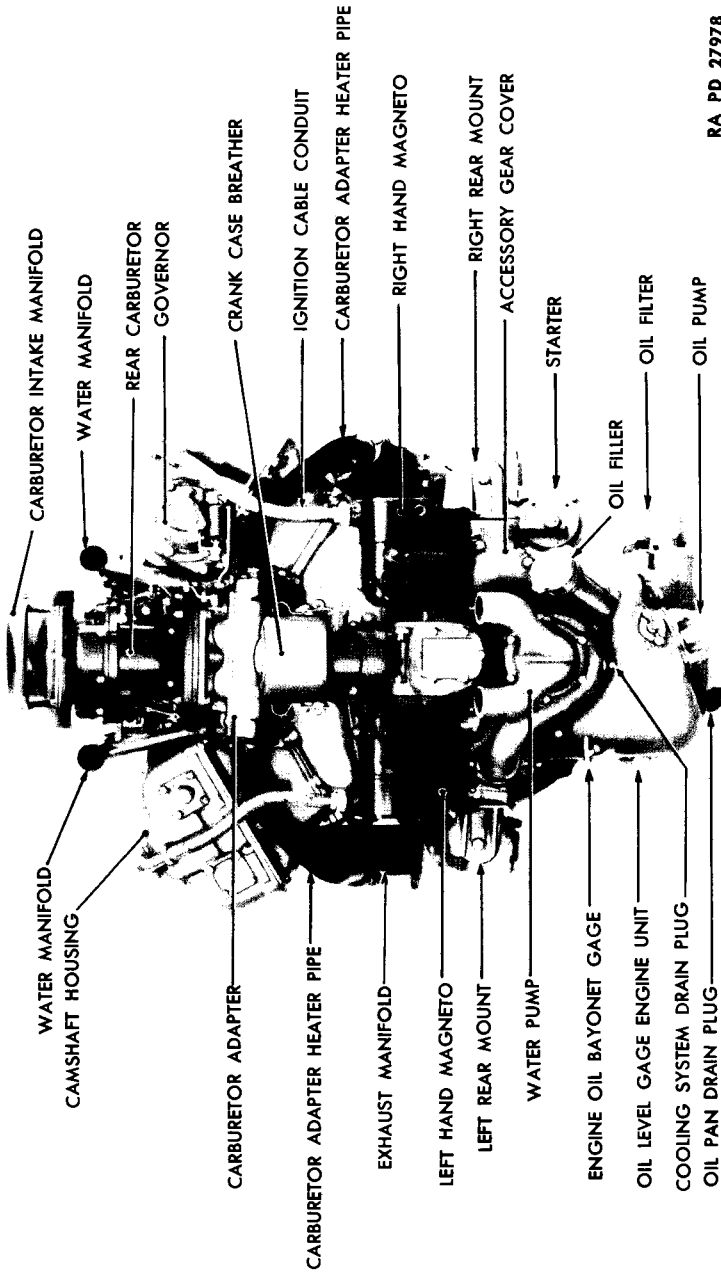


Figure 19—Engine—Rear View

RA PD 27978



3-INCH GUN MOTOR CARRIAGE M10A1

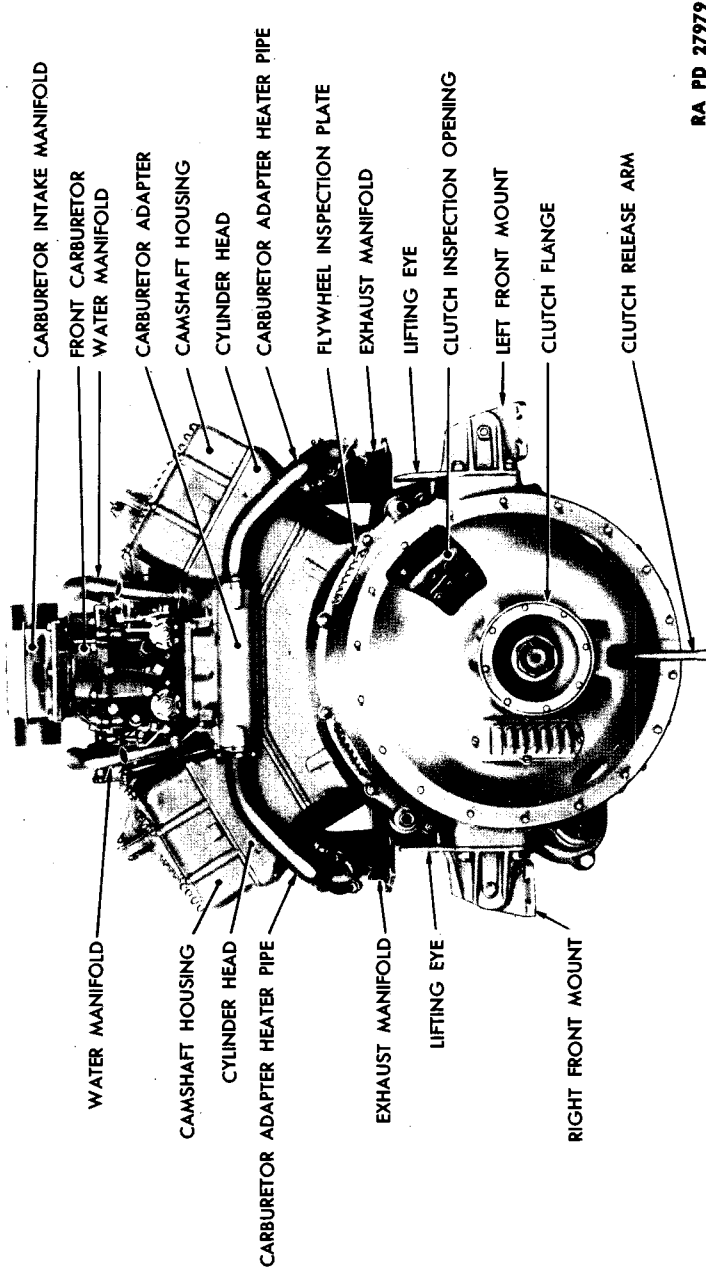


Figure 20—Engine—Front View

**ENGINE****f. No Fuel in the Carburetor Bowl.**

Possible Cause	Possible Remedy
Fuel shut-off valves closed.	Open valves.
Fuel filter clogged.	Clean fuel filter.
Fuel lines clogged.	Blow out or replace.
Fuel pump faulty.	Replace (par. 59 d).

**g. No Spark at One or More Spark Plugs.**

Magneto ground wires shorted.	Replace.
Spark plug wires broken or faulty insulation.	Replace (par. 50 b).
Spark plugs shorted.	Replace.
Ignition switch faulty.	Replace.
Magnetos faulty.	Replace (par. 46 b).

**h. Ignition Timing (Engine Backfires but Does Not Start).**

Magnetos out of time.	Notify ordnance maintenance personnel.
Spark plug wires on wrong terminal of magnetos.	Connect as shown in figure 30.

**i. Engine Runs Unevenly and Black Smoke Is Emitted from the Exhaust.**

Fuel mixture too rich due to:

Carburetor float level too high.	Replace carburetor (par. 52 e).
Fuel pump pressure too high.	Replace fuel pump (par. 58 c).

**j. Engine Runs Unevenly and Backfires Through the Carburetors.**

Fuel mixture too lean due to:

Engine cold.	Run engine until normal temperature is reached.
Carburetor float level too low.	Replace carburetor (par. 52 e).
Dirt in carburetor.	Replace carburetor (par. 52 e).
Fuel pump pressure too low.	Replace fuel pump (par. 58 c).
Air leak at carburetor gasket or carburetor adapter gasket.	Tighten or replace gasket.

Ignition trouble due to:

Magneto distributor plate cracked.	Replace magneto (par. 46 b).
Spark plug wires on wrong terminals of magnetos.	Connect as shown in figure 30.
Spark plug wires (broken or faulty insulation).	Replace (par. 50 b).
Spark plug gap too wide.	Replace plugs (par. 49).

3-INCH GUN MOTOR CARRIAGE M10A1

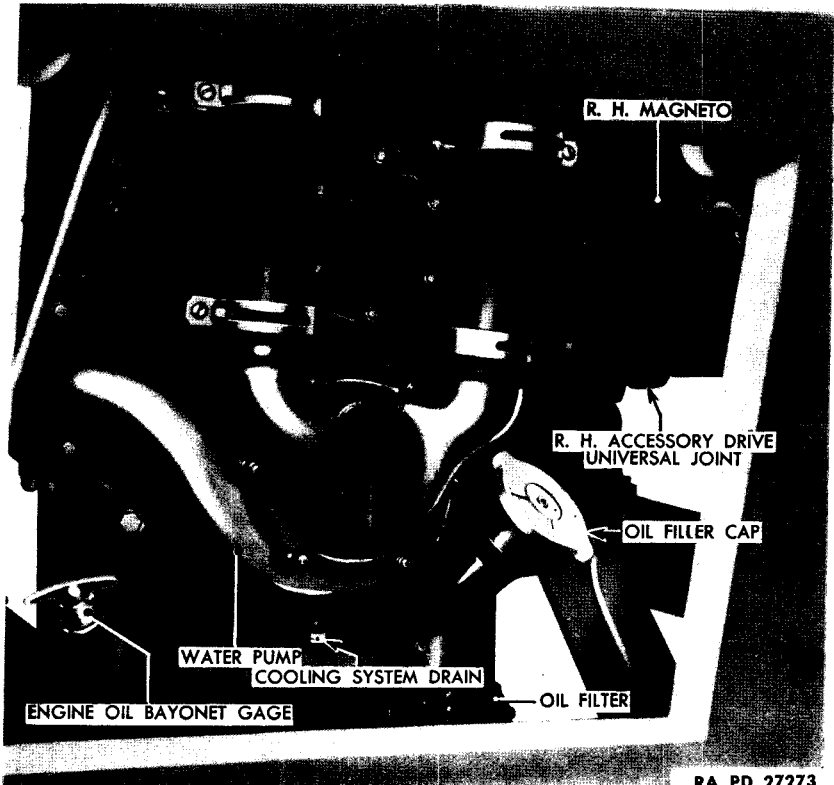


Figure 21—Engine—Viewed Through the Rear Door

Possible Cause	Possible Remedy
<p>Engine valves due to:</p> <ul style="list-style-type: none"> <li>Insufficient push rod clearance.</li> <li>Sticky valve guides, broken valve springs, and valve seats leaking.</li> </ul>	<ul style="list-style-type: none"> <li>Notify ordnance maintenance personnel.</li> <li>Notify ordnance maintenance personnel.</li> </ul>

k. Engine Overheating.

<ul style="list-style-type: none"> <li>Water low.</li> <li>Air flow restricted through radiator core.</li> <li>Loose fan belts.</li> <li>Engine operating with late spark.</li> <li>Thermostat faulty.</li> </ul>	<ul style="list-style-type: none"> <li>Refill.</li> <li>Clean (par. 33 a (5)).</li> <li>Adjust (par. 66 b).</li> <li>Time ignition (par. 47).</li> <li>Replace (par. 68 b).</li> </ul>
---	--

ENGINE

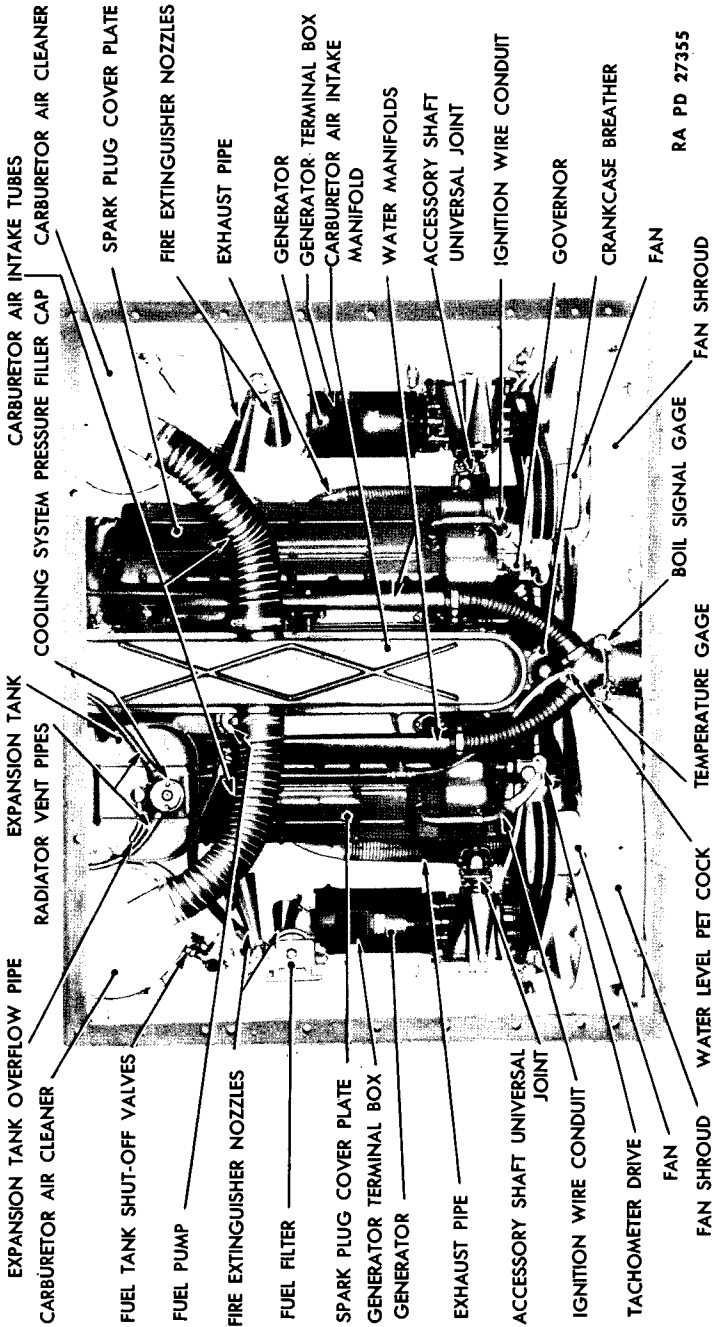


Figure 22 -- Engine Compartment -- from Above

**3-INCH GUN MOTOR CARRIAGE M10A1**

**l. Lack of Power.**

Possible Cause	Possible Remedy
Spark plug gap too wide.	Replace spark plugs (par. 49).
Track suspension too tight.	Adjust (par. 129 b).
Track suspension dirty.	Clean.
Ignition timing late.	Time ignition (par. 47).
Low compression.	Notify ordnance maintenance personnel.
Valve timing.	Notify ordnance maintenance personnel.
Clutch slipping.	Adjust (par. 115 b, c, d). Replace (par. 115 g).

**m. Low Oil Pressure.**

Oil supply low.	Refill.
Over diluted oil.	Change oil.
Faulty oil pressure regulator.	Notify ordnance maintenance personnel.
Excessive bearing clearance.	Notify ordnance maintenance personnel.

**n. Abnormal Engine Noise.**

Valve mechanism and camshaft idling noise due to:

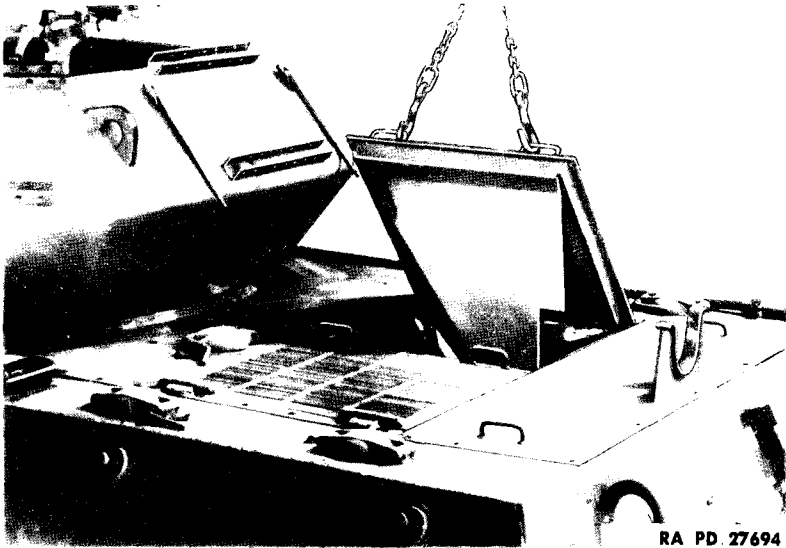
NOTE: Camshaft backlash noise below 500 revolutions per minute is not to be considered abnormal.

Broken or scored push rod.	Notify ordnance maintenance personnel.
Broken valve springs.	Notify ordnance maintenance personnel.
Connecting rod bearing knock.	Notify ordnance maintenance personnel.
Crankshaft main bearing knock.	Notify ordnance maintenance personnel.

Engine pinging or spark knock due to:

Excessive carbon formation.	Notify ordnance maintenance personnel.
Ignition timing too early.	Time ignition (par. 47).
Wrong type spark plug.	Replace with correct type (par. 49).
Low octane fuel.	Drain and refill with correct quality (par. 4 i).
Spark fails to retard due to broken magneto governor springs or sluggish action of governor weights.	Notify ordnance maintenance personnel.

## ENGINE



**Figure 23—Removing Right Door**

### 37. ENGINE REPLACEMENT.

#### a. Removal of Engine.

(1) **TURN BATTERY MASTER SWITCH "OFF."**

(2) **REMOVE DOORS AND COVERS FROM THE ENGINE COMPARTMENT.** Remove five cap screws which secure each door to top of hull and lift doors from vehicle (figs. 23 and 24), with a chain fall or hoist. Remove the cap screws which hold rear cover plate to top of hull and lift from hull with chain fall or hoist (fig. 25). Remove cap screws which hold front cover to top of hull and lift cover from hull.

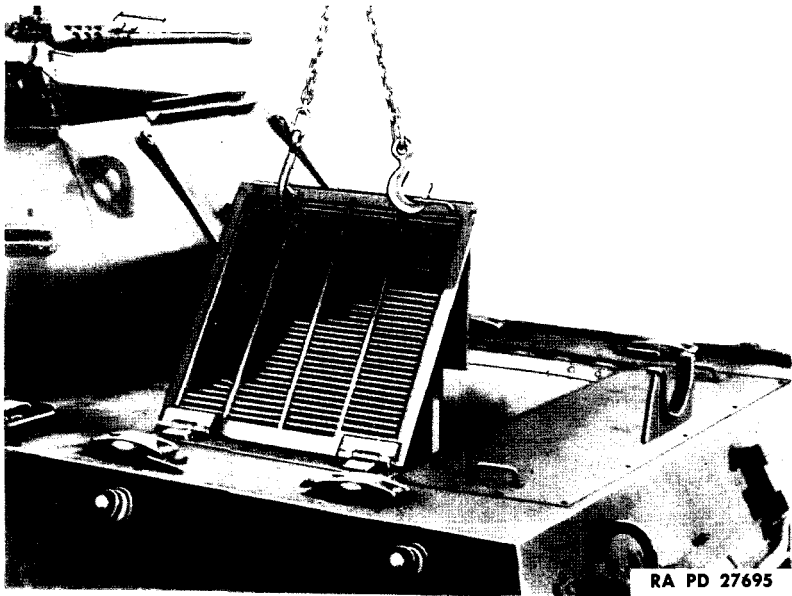
(3) **OPEN REAR DOOR OF THE ENGINE COMPARTMENT.** Remove the three cap screws which hold door closed. To open this door all the way, raise radiator air baffle and allow it to rest on top of door after door is open.

(4) **REMOVE ENGINE COMPARTMENT FLOOR PLATE.** Remove lock wires from cap screw heads which hold floor plate to hull. Remove cap screws leaving one at each corner of floor plate. Place a jack at center of the plate and remove remaining cap screws, then lower floor plate with jack.

(5) **DRAIN COOLING SYSTEM.** Remove drain plug at bottom of water pump (fig. 21) and drain cooling system.

(6) **DRAIN ENGINE OIL.** Remove drain plug at bottom of engine oil pan and drain oil (a container holding 8 gallons or more is required).

## 3-INCH GUN MOTOR CARRIAGE M10A1



**Figure 24—Removing Left Door**

(7) REMOVE OIL FILLER PIPE (fig. 21). Remove three nuts which hold oil filler pipe to engine oil pan. Remove filler pipe.

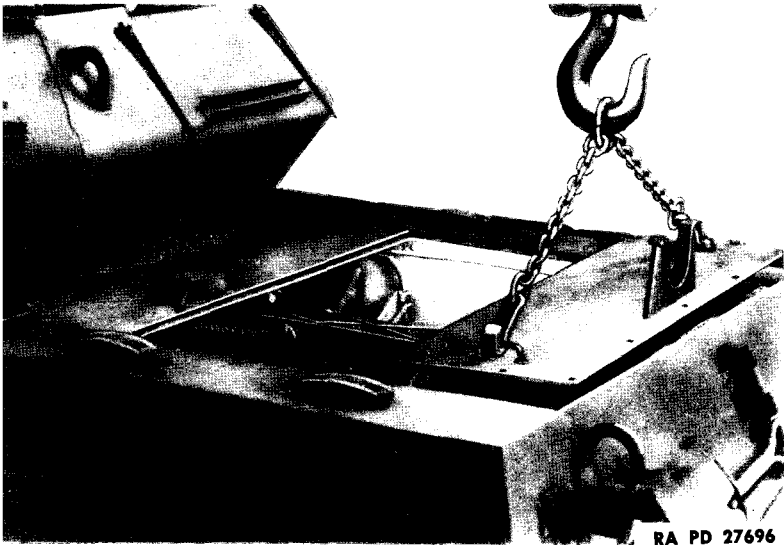
(8) REMOVE WATER PUMP AND RADIATOR EXPANSION TANK. Remove four nuts securing water pump to engine and disconnect water pump hose. Remove water pump (par. 65 c). Remove cooling system expansion tank and hose (par. 69 b).

(9) REMOVE MISCELLANEOUS ELECTRICAL CONNECTIONS. Disconnect the degasser wires from carburetors (fig. 37); disconnect temperature gage wires and degasser conduit from engine. Disconnect starter cable at starter. Disconnect oil level indicator wire on left side of engine oil pan. Disconnect oil pressure gage connection at right rear end of engine oil pan. Disconnect ground wire (running from each magneto to the ignition switch) at each magneto (fig. 30); then with two short lengths of wire, ground the ground wire terminal of each magneto to cover retainer screws (fig. 30). This will prevent possibility of engine starting in the event it is turned over.

(10) REMOVE INLET AND OUTLET CONNECTIONS FROM RADIATOR. Loosen clamps and remove two top radiator hose. Remove four cap screws from radiator upper and lower water connections. Remove connections (including thermostat and gasket).

(11) REMOVE FAN BELTS. To remove fan belts, loosen four bolts

**ENGINE**



**Figure 25—Removing Engine Compartment Rear Cover Plate**

securing each accessory drive housing to hull (fig. 45). Raise housings to provide slack for belts and remove belts.

(12) **REMOVE FAN AND SHROUD ASSEMBLIES AND ACCESSORY SHAFTS.** To remove fan and shroud assemblies and accessory shafts, remove six bolts holding each fan shroud in place. Remove each fan and shroud assembly from engine compartment. Remove the four bolts from flanges of universal joint at each end of accessory drive shaft. Remove accessory shafts.

(13) **DISCONNECT THE TACHOMETER CABLE AND FIRE EXTINGUISHER NOZZLES.** Disconnect tachometer cable from tachometer drive unit located on left-hand camshaft housing. Remove pipe connections from upper fire extinguisher nozzles on right- and left-hand side of engine compartment. Remove two cap screws from each fire extinguisher nozzle bracket. Remove nozzles and brackets.

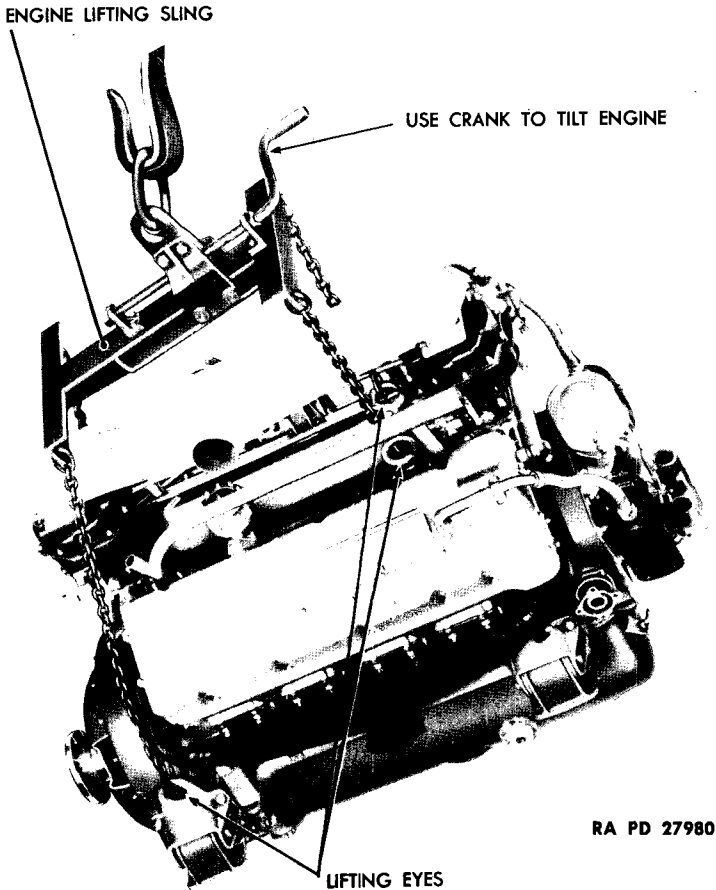
(14) **DISCONNECT FUEL AND PRIMER LINES.** Shut off fuel valves (fig. 9). Disconnect fuel line from fuel pump. Disconnect primer line at left side of forward carburetor, and remove primer lines running to each intake manifold.

(15) **DISCONNECT THROTTLE ROD.** Disconnect and remove throttle control rod running from throttle cross shaft on bulkhead to throttle control bracket in center of the engine (fig. 39).

(16) **REMOVE AIR CLEANERS AND TUBES.** Remove the two air cleaners and tubes (par. 55 c).



**3-INCH GUN MOTOR CARRIAGE M10A1**



**Figure 26—Engine Lifting Sling**

(17) **DISCONNECT REAR UNIVERSAL JOINT AND CLUTCH THROW-OUT CLEVIS.** Lift the cover over propeller shaft rear universal joint and remove eight bolts which connect universal joint to clutch shaft flange (fig. 35). Remove clevis pin from clutch release arm (fig. 18).

(18) **REMOVE EXHAUST PIPES AND DISCONNECT ENGINE MOUNTS FROM SUPPORT BRACKETS.** Remove six bolts that secure exhaust pipes to exhaust manifolds on each side of engine. Remove exhaust pipes. Remove four bolts from both engine rear support brackets and two rear bolts from both engine front support brackets. Remove plates from clutch housing cover which are directly in front of engine front support brackets; then remove two front bolts from both support brackets.

(19) **REMOVE ENGINE FROM HULL** (fig. 26). Attach engine sling

## ENGINE

(41-S-3831) to the four lifting eyes on engine (fig. 26). Remove engine front hull with chain fall or hoist. Figure 26 shows adjustable lifting sling and position of engine for removal. It will be necessary to adjust sling to tilt engine to obtain clearance at clutch housing and magnetos. After engine is removed, make sure that both magnetos are grounded (par. 37 a (9)) to eliminate the possibility of engine starting if it should be turned over while out of vehicle.

(20) REMOVE EXHAUST PIPES FROM REAR OF HULL. Remove the five bolts from both the external exhaust pipes on rear of hull and remove exhaust pipes.

### b. Engine Installation.

(1) SET ENGINE IN HULL. If a new or replacement engine is to be installed, the water pump assembly and the oil filler pipe are to be removed from the engine before attempting the installation. Remove the short lengths of wire from each magneto ground. Attach the engine lifting sling (41-S-3831) to the four lifting eyes on the engine (fig. 26). Attach a chain fall or hoist, raise the engine, and adjust the lifting sling to tilt the engine to approximately the angle shown in figure 26. Enter the engine into the hull with the front end pointing to the left-hand front corner of the engine compartment, lower the engine into place, adjusting the lifting sling as necessary to obtain clearance at clutch housing and magnetos. Line up the bolt holes in the engine mounts and supports.

(2) INSTALL EXHAUST PIPES AND CONNECT ENGINE MOUNTS. Using new bolts and gaskets, assemble the exhaust pipe to the exhaust manifold on each side of the engine. Using new packing, install the five bolts securing each external exhaust pipe to the rear of the hull. Install the four bolts securing the engine mounts to both engine rear support brackets and the two rear bolts in both engine front support brackets. Install the two front bolts in both front support brackets, working through the opening in the clutch housing cover.

(3) CONNECT REAR UNIVERSAL JOINT AND CLUTCH THROW-OUT CLEVIS. Install the eight bolts which connect the universal joint to the clutch shaft flange (fig. 35). Install the clevis pin which connects the clutch release arm to the clutch release clevis. Adjust the clutches (par. 115 d).

(4) INSTALL AIR CLEANERS. Install the two air cleaners and tubes (par. 55 c).

(5) CONNECT THROTTLE ROD. Connect throttle rod which runs from the throttle cross shaft on the bulkhead to the throttle control bracket at the center of the engine. Adjust linkage (par. 56 b) if required.

(6) CONNECT FUEL AND PRIMER LINES. Connect fuel line to fuel

**3-INCH GUN MOTOR CARRIAGE M10A1**

pump. Connect primer line at left side of forward carburetor and primer lines running to each intake manifold.

(7) **CONNECT TACHOMETER CABLE AND FIRE EXTINGUISHER NOZZLE.** Connect tachometer cable to tachometer drive unit located on left-hand camshaft housing. Install upper fire extinguisher nozzles and brackets on both sides of engine compartment. Connect fire extinguisher pipes to nozzles.

(8) **INSTALL FAN AND SHROUD ASSEMBLIES AND ACCESSORY SHAFTS.** Place fan and shroud assemblies in position in front of radiator. Place a new felt gasket between shroud and holding plate. Place a rubber bushing and collar in mounting holes, and install six bolts, securing each fan shroud to hull plate. Place right and left accessory drive shafts in position, and install four bolts in flanges of universal joint at each end of accessory drive shafts.

(9) **INSTALL FAN BELTS.** To install the fan belts, loosen four bolts securing each accessory drive housing to hull (fig. 45). Raise housings to provide slack for belts. Install belts and adjust to proper tension (par. 66 b).

(10) **INSTALL INLET AND OUTLET CONNECTIONS TO RADIATOR.** Install four cap screws in radiator upper and lower water connections to radiator (including thermostat and gaskets). Install two top radiator hose and tighten clamps.

(11) **CONNECT MISCELLANEOUS ELECTRICAL CONNECTIONS.** Connect oil pressure gage connection at right rear end of engine oil pan. Connect oil level indicator wire to oil level indicator on left side of oil pan. Connect starter cable to starter. Install degasser conduit on engine and connect degasser wires to degasser connections on carburetors. Connect temperature gage, and boil signal wires to engine units.

(12) **INSTALL WATER PUMP AND RADIATOR EXPANSION TANK.** Install water pump with gaskets on four studs on engine and secure with four fiber insert nuts. Install the two hose running from water pump to radiator lower water connection and tighten hose clamps. Install expansion tank (par. 69 b).

(13) **INSTALL OIL FILLER PIPE.** Install oil filler pipe and secure it with three fiber insert nuts.

(14) **FILL ENGINE OIL PAN.** Install drain plug in bottom of engine oil pan and fill with 8 gallons of specified oil.

(15) **FILL COOLING SYSTEM.** Install drain plug in water pump (fig. 21) and fill cooling system to level of the petcock in radiator upper water connection (fig. 46).

(16) **INSTALL ENGINE FLOOR PLATE.** Place a jack at the center

## ENGINE

of the floor plate and raise the plate against the bottom of the hull. Install a cap screw at each corner of the plate. Remove the jack and install the remainder of cap screws and secure with locking wires.

(17) **CLOSE AND FASTEN REAR DOOR OF ENGINE COMPARTMENT.** Raise the air baffle and close the engine compartment rear door. Install and tighten the three cap screws securing the door to rear of hull.

(18) **INSTALL DOORS AND COVERS ON ENGINE COMPARTMENT.** Place the front cover on the engine compartment and install the cap screws. With a chain fall or hoist place the rear cover (fig. 25) in position and install the cap screws. With a chain fall or hoist, place the right and the left doors in position (figs. 23 and 24), and install the cap screws.

(19) **TURN BATTERY MASTER SWITCH ON, START ENGINE, AND CHECK FOR OIL OR WATER LEAKS.**

### 38. ENGINE MOUNTS (figs. 17 and 18).

a. **Description.** The four engine mounts used to support the engine provide flexible rubber installation between the engine and its mounting brackets.

#### b. Engine Mounts (Front) Replacement (Right or Left).

(1) **REMOVAL.** Remove engine compartment floor plate (par. 37 a (4)). Place a jack under front of the engine oil pan, using a wood block between the pan and jack. Lift engine enough to take weight off engine mounts. Remove the four bolts which hold the mount to the support bracket. Two of these bolts are accessible through the inspection opening in the bulkhead and two through the engine floor plate opening. Remove the long bolt which holds the halves of the mount together. Remove the four nuts which hold the mount to the clutch housing. The two rear nuts are accessible through the engine floor plate opening, and the two front nuts through the inspection opening in the bulkhead.

(2) **INSTALLATION.** To reinstall engine front mounts, reverse the sequence of the steps of the removal procedure.

#### c. Engine Mounts (Rear) Replacement (Right or Left).

(1) **REMOVAL.** Remove engine compartment floor plate (par. 37 a (4)). Place a jack under rear of the engine oil pan, using a wood block between the pan and jack. Lift the engine enough to take weight off the engine mounts. Remove the four bolts which hold the mounts to the support bracket. Remove the four nuts which hold the mount to the engine. Remove the mount.

(2) **INSTALLATION.** Reverse the sequence of the steps in the removal procedure.

**3-INCH GUN MOTOR CARRIAGE M10A1**

**39. GOVERNOR.**

a. **Description.** The speed of the engine is regulated and limited by the use of additional dual throttle plates located in each of the carburetor adapters directly under each carburetor. These carburetor adapter throttles are connected by a rod, which in turn is connected to the governor located at the rear of the right-hand camshaft housing and is driven by the right-hand intake camshaft. With the engine idling, these governor-actuated throttles are in the wide-open position. As the engine speed is increased the action of the governor partially closes the throttles, thus limiting the maximum engine speed to approximately 2,600 revolutions per minute under full load. All maintenance on the governor must be referred to ordnance maintenance personnel.

b. **Link Adjustment.** The governor throttle connecting link should be adjusted by means of the clevis on the forward end so that with engine stopped, both throttle levers are against the stop on both carburetor adapters (figs. 19 and 20).

**40. VALVE MECHANISM.**

a. Two inlet and two exhaust valves are provided for each cylinder and are operated by overhead camshafts, two in each cylinder head. One shaft operates the intake valves and the other the exhaust valves. Special nonadjustable valve push rods are used. The clearance of 0.027 to 0.030 inch is established during manufacture or overhaul, and since this clearance is established cold and is greater than the maximum normal expansion of the parts, it should require no attention by the using arms. Both intake and exhaust valve ports are provided with steel alloy insert seats.

**41. MANIFOLDS.**

a. **Intake.** The intake manifolds are cast integral with the cylinder heads and are open at each end. Carburetor adapters are installed between the carburetors and the intake manifolds. These adapters are likewise connected to the exhaust manifolds which heat the fuel air mixture as it comes from the carburetors. These adapters each contain two butterfly valves operated by the engine speed governor (par. 39).

**b. Exhaust Manifolds.**

(1) **DESCRIPTION.** Two exhaust manifolds are used, one attached to each cylinder head. The end of each manifold is attached to the carburetor adapter housing by means of a connecting pipe.

(2) **EXHAUST MANIFOLD REPLACEMENT.** Remove the three cap screws from the upper flange and the three bolts from the lower flange of the carburetor heater pipe which connects the ends of the exhaust manifold to the carburetor adapter. Remove the 6 bolts at the center

## ENGINE

of flange of the exhaust pipe. Remove the 16 nuts securing the manifold to the cylinder head and remove the manifold. This procedure applies to either the right or the left manifold. To install, reverse the sequence of the steps in the removal procedure.

### c. Water Manifolds.

(1) **DESCRIPTION.** Two water manifolds are used, one attached to each cylinder head. The rear ends of the manifolds are attached to the top of the radiator by hose connections. The front ends are attached to the expansion tank (fig. 47) by hose connections.

(2) **WATER MANIFOLD REPLACEMENT.** Remove drain plug at bottom of water pump (fig. 21) and drain approximately 2 gallons of water. Loosen the hose clamps at each end of the manifold and remove the hose. Remove the two nuts and washers from the two flanges securing the manifold to the cylinder head and remove the manifold. (The above procedure applies to either manifold.) To install, reverse the sequence of the steps in the removal procedure.

## 42. OIL PUMP (fig. 19).

a. The oil pump is a gear type driven from the lower camshaft drive gear. The oil pump does not require periodical checking. To remove the oil pump, remove engine compartment floor plate (par. 37 a (4)). Remove the four nuts holding the oil pump to the crankcase and remove the pump. To install the oil pump, reverse the sequence of the steps in the removal procedure.

## 43. OIL FILTER (fig. 27).

a. **Description.** The oil filter consists of a stack of wheel-shaped disks, separated from each other by spoked spacer pieces and is mounted on a rotatable spindle. Located adjacent to this stack of disks and spacers, is a stack of cleaner blades mounted on a rod in such manner that each cleaner blade enters the space between adjacent disks. Solids, too large to pass between the disks, remain on the outer surface until such time as the disks are rotated past the cleaner blades. Accumulated solids are removed from the surface by combing action of the cleaner blades and collect in the sump around the filter. The filter disks are rotated by a hydraulic motor operated by oil pressure from the engine. The oil filter is located on the right side of the oil pan at the rear, accessible through the engine compartment rear door (fig. 17).

b. **Operation Check.** To check the operation of the filter, remove manual turning nut, turn this nut end for end, and install it back on shaft from which it was removed (fig. 27). Run engine at speed which shows oil pressure at approximately 30 pounds. The manual turning nut will rotate very slowly if the filter is operating. Mark the nut and check position of this mark, after engine has been running for 5

3-INCH GUN MOTOR CARRIAGE M10A1

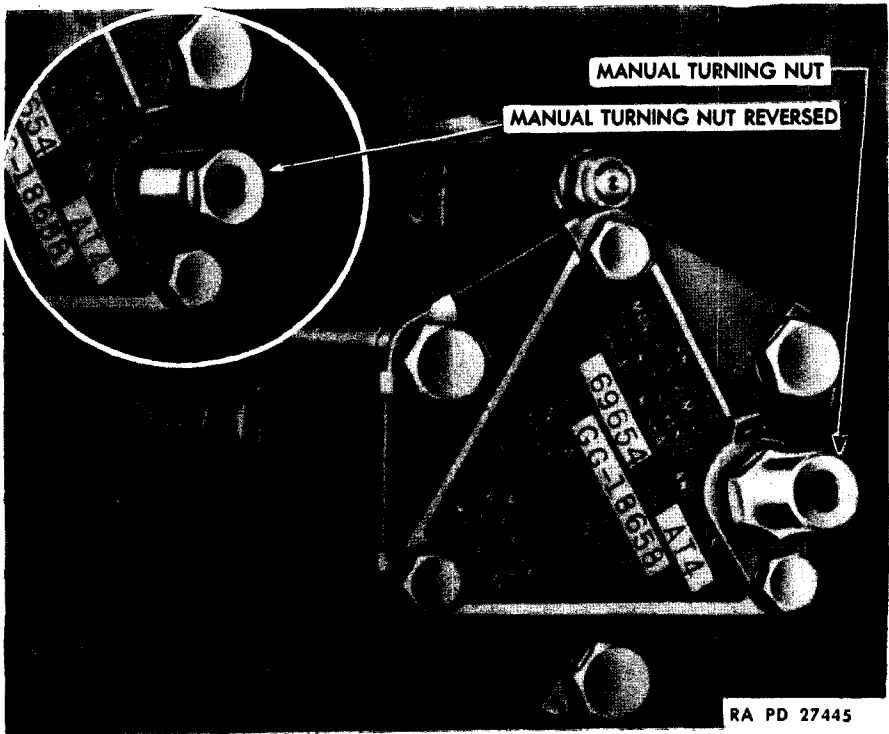


Figure 27—Oil Filter

minutes, to see if it has rotated. After check is made, replace manual turning nut in original position, and secure with lock wire. If filter nut fails to turn, remove unit from engine for examination or replacement.

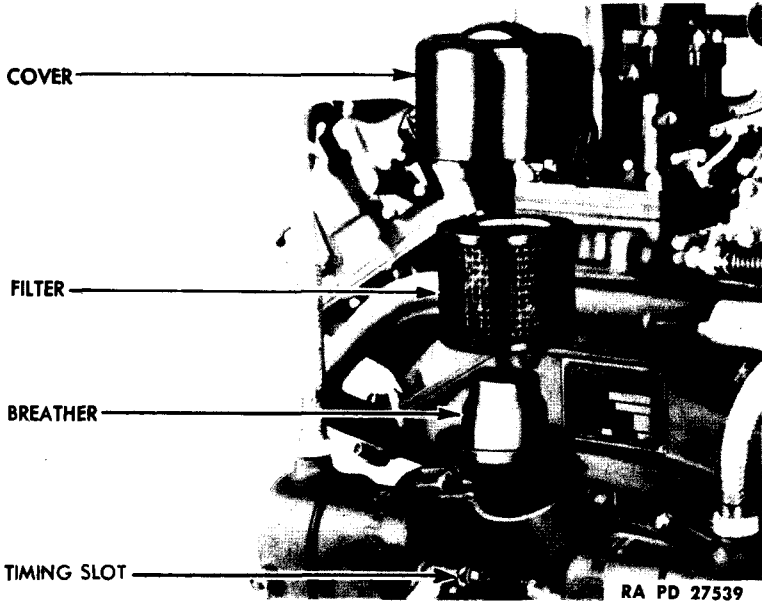
c. **Oil Filter Replacement.** Remove engine compartment floor plate (par. 37 a (4)). Remove six nuts securing filter to oil pan and remove filter unit. Install filter unit and secure filter to oil pan with six nuts. Install engine compartment floor plate (par. 37 b (16)).

d. **Cleaning.** Remove filter (par. 43 c). Clean filter element by washing in dry-cleaning solvent. Turn element by means of manual turning nut while cleaning. Continue to rotate element in solvent until all foreign material has been removed. When thoroughly clean, allow to dry. **NOTE:** Do not blow air on the element.

44. **CRANKCASE BREATHER** (fig. 28).

a. **Description.** The crankcase breather is located directly above the water pump, accessible either from above or through the engine compartment rear door (fig. 21). Figure 28 is an exploded view of the crankcase breather and shows the cover and the filter element.

## ENGINE



**Figure 28—Crankcase Breather**

**b. Servicing Filter Element.** To remove filter element for cleaning, release the two holding clips and lift off cover. Lift off the filter element. The filter should be cleaned by washing in dry-cleaning solvent. Blow out with compressed air, and when dry, dip in seasonal grade engine oil. Reinstall the filter element and the cover.



3-INCH GUN MOTOR CARRIAGE M10A1

Section XII

IGNITION SYSTEM

	Paragraph
Ignition system .....	45
Magnetos .....	46
Ignition timing and magneto governor advance .....	47
Ignition switch .....	48
Spark plugs .....	49
Spark plug wires and conduits .....	50

45. IGNITION SYSTEM.

a. **Description.** The Ford tank engine ignition system consists of two magnetos (par. 46), aircraft type spark plugs (par. 49) and the necessary connecting high tension wires (par. 50). The ignition is turned off when the magnetos are grounded by means of the ignition switch on the instrument panel (par. 5 a (6)). If at any time the ground wires running from the magnetos to the ignition switch were broken, the ignition could not be turned off with the ignition switch. On the other hand if these wires became shorted, it would be impossible to turn the ignition on with the ignition switch. The numbering of the cylinders and the firing order is shown in figure 29.

b. **Trouble Shooting.** Trouble shooting for the ignition system is covered in the engine section of this book (par. 36).

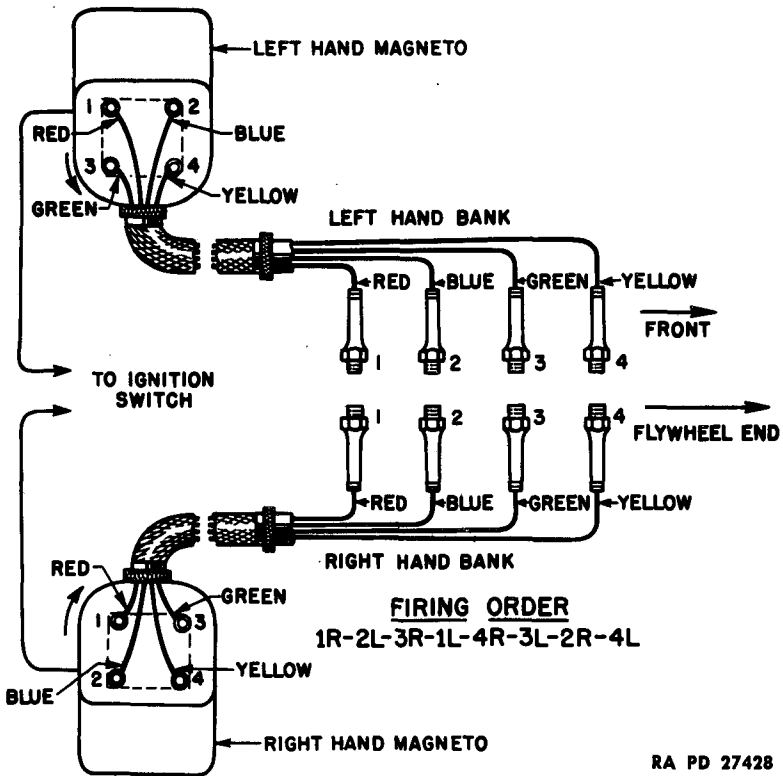
46. MAGNETOS.

a. **Description.** Two magnetos are used, one firing the cylinders in the right bank, and the other firing the cylinders in the left bank. Right and left throughout this book is determined when looking at the engine from the rear of the vehicle, looking toward the front. These magnetos employ the induction principle of current generation, the coil windings being stationary and the magnet rotated between laminated hole shoes. The automatic spark advance mechanism is a part of the engine, and is not a part of the magnetos. One governor assembly advances the spark of both magnetos together.

b. **Replacement.**

(1) **REMOVAL** (fig. 30). Remove four screws securing breaker point inspection plate. Remove plate. Remove four screws securing magneto circular inspection plate. Remove plate. Remove ground wire terminal screw. Unscrew knurled nut securing ground wire conduit to the magneto housing and remove ground wire and conduit. Remove four screws securing four ignition (high tension) cables to distributor plate and lift ignition cable terminals out of recesses. Unscrew knurled nut securing ignition cable conduit to magneto and

IGNITION SYSTEM



RA PD 27428

Figure 29—Cylinder Numbering and Firing Order

remove conduit and cables. Remove lock wire and upper and lower nuts securing magneto to accessory gear cover and remove magneto. **CAUTION:** Note the position of the rotor arrow (fig. 30) in the center of the distributor plate before removing the magneto. The magneto must be replaced with the arrow pointing to the same terminal as when removed. If engine has been turned over with magneto removed, proceed as outlined in subparagraph c below.

(2) **INSTALLATION.** To install the magnetos, reverse the sequence of the steps in the removal procedure, and also check the ignition timing as outlined in paragraph 47, and adjust the magnetos in the housing slots as outlined in paragraph 47 a (4).

c. **Installing Magnetos When Timing Has Been Lost.** If timing has been lost due to engine having been turned over while either magneto was removed, it will be necessary to get number 1 piston of the right-hand bank of cylinders at the top of its compression stroke, to set the right-hand magneto, or number 1 piston of the left

3-INCH GUN MOTOR CARRIAGE M10A1

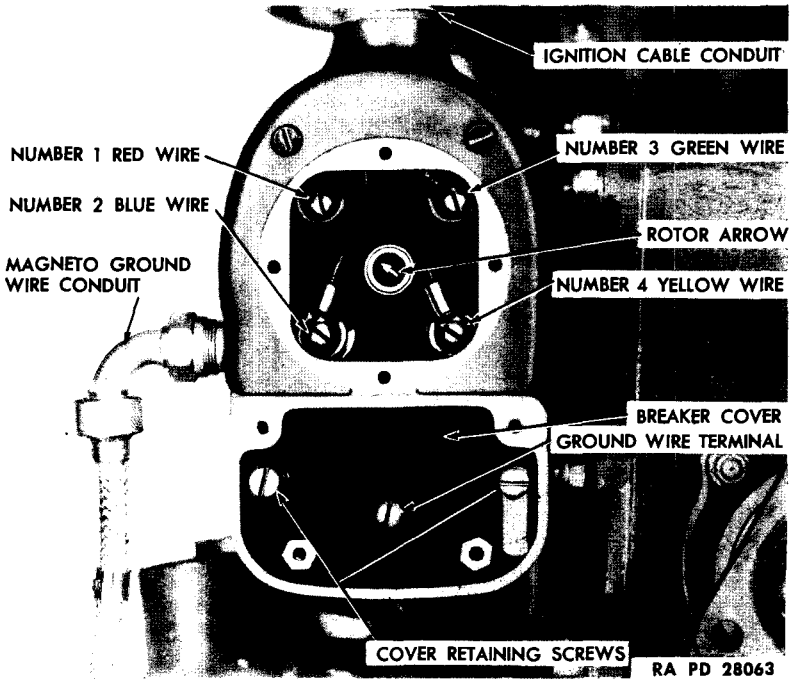
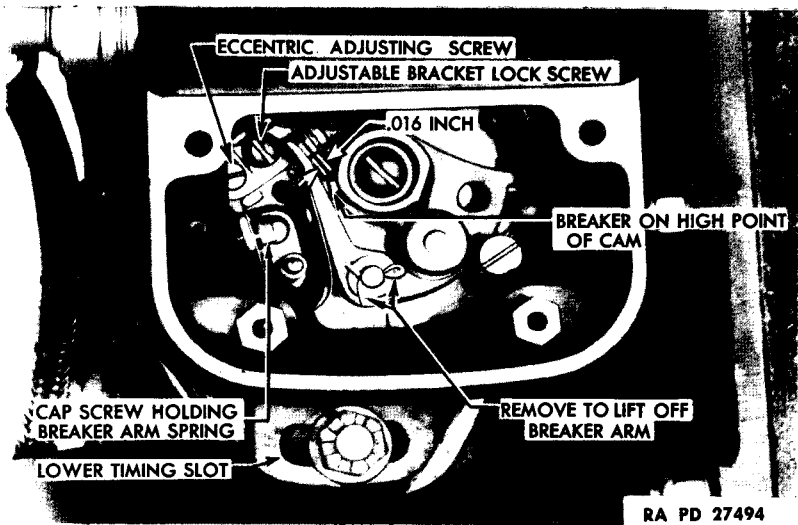


Figure 30—Magneto

bank for the left-hand magneto. Proceed as follows: Make certain ignition switch is turned off. Remove number 1 spark plug from the right bank (left bank for left-hand magneto). Install a compression gage in number 1 spark plug hole. To turn the engine by hand, uncover the rear universal joint, and use a bar in the universal joint as shown in figure 35. Turn the engine in the direction indicated by the arrow in figure 35 until the compression gage shows piston is coming up on compression stroke. Continue to turn until the compression reading no longer increases. This will place number 1 piston approximately at top of the stroke. Turn the magneto coupling until the arrow in the center of the rotor (fig. 30) points to number 1 cylinder (red wire). Install the magneto in engine (par. 46 b (2)) and time ignition (par. 47 a).

d. **Check and Reset Breaker Points.** Remove the magneto (par. 46 b (1)). Adjust the breaker points to an opening of 0.016 inch when the breaker arm rests on the high point of the cam as shown in figure 31. Loosen the lock screw of the adjustable bracket (fig. 31). Turn eccentric adjusting screw (fig. 31) until a 0.016-inch feeler gage can be moved between the points with a slight drag, then

IGNITION SYSTEM



**Figure 31—Magneto with Breaker Point Cover Removed**

tighten the lock screw to hold the adjustment. The contact points must be free from oil or grease and be in alignment with each other, so that the full surfaces of both contacts meet squarely. Pitted contact points should be replaced (par. 46 e). In emergencies, the points sometimes can be cleaned with an extremely fine hone. Do not use a file. When point replacement becomes necessary, always replace both the breaker arm and the contact bracket.

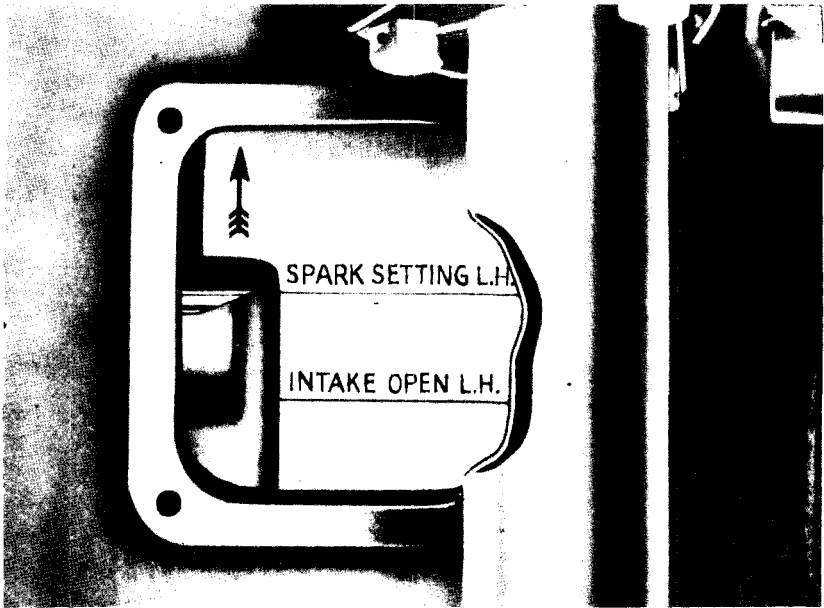
e. **Breaker Point Replacement** (fig. 31). To remove the breaker points, remove the cap screw which holds breaker arm spring, then remove cotter pin and washer from breaker arm pin and lift out the breaker arm. Remove the lock screw which holds adjustable bracket, and lift bracket off of the eccentric adjusting screw. To reinstall the breaker points, reverse the sequence of the steps in the removal procedure and adjust breaker points (par. 46 d).

**47. IGNITION TIMING AND MAGNETO GOVERNOR ADVANCE.**

a. **Procedure for Checking Timing.**

(1) **PRELIMINARY STEPS.** Open the engine compartment doors. Remove the four screws from the flywheel inspection plate (fig. 18) on the top left side of the flywheel housing and remove the plate. Make certain that the ignition switch is off; then turn engine by hand (fig. 35) until the timing mark "SPARK SETTING R.H." appears at the opening in the flywheel housing from which the plate was removed (fig 32). Make a narrow chalk mark across the flywheel

## 3-INCH GUN MOTOR CARRIAGE M10A1



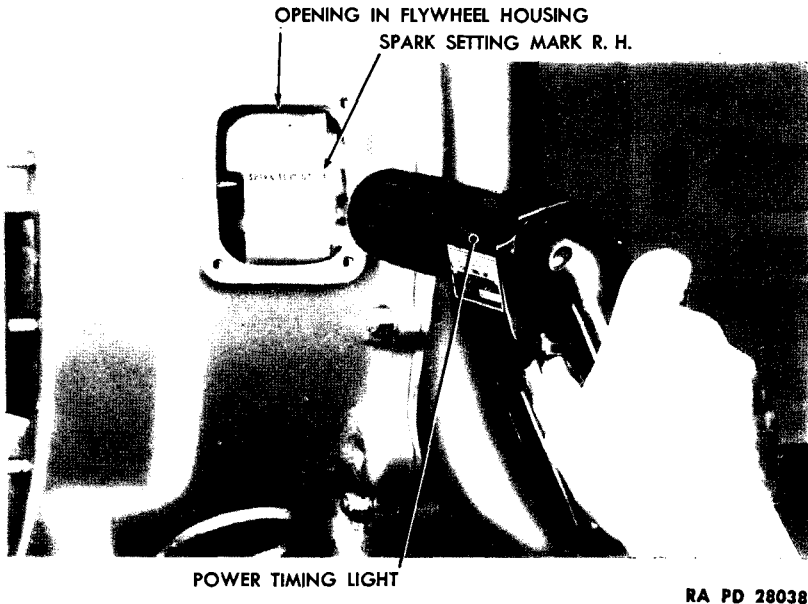
RA PD 27228

**Figure 32—Flywheel Timing Marks**

on the “SPARK SETTING” mark. Turn the engine until the other timing mark “SPARK SETTING L.H.” (fig. 32) appears at the opening and make a chalk mark as outlined above. **NOTE:** On early production engines having the mark “SPARK RETARDED” on the flywheel instead of “SPARK SETTING”, the timing is correct when the pointer in the flywheel housing is seven-eighths inch to the right of the “SPARK RETARDED” mark when the spark occurs. Therefore, a chalk mark should be placed across the flywheel seven-eighths inch to the right of both of the “SPARK RETARDED” marks.

(2) **CONNECTING THE TIMING LIGHT.** To connect the timing light, remove the nuts from the spark plug covers and remove the covers. Remove the spark plug wire from number 1 spark plug in the right bank to check right-hand magneto. (Use number 1 spark plug in left-hand bank to check left-hand magneto.) Procure a short piece of high tension wire and attach connector and terminal. Insert this wire in number 1 spark plug (fig. 34). Attach the high tension lead (large wire) of the timing light to the terminal of number 1 spark plug wire and also to the connector of the short piece of wire just inserted in the spark plug. Connect one end of a 12-foot length of insulated wire to the positive post of the forward battery; attach the other end to the positive (red) low tension lead of the timing light. Connect the other low tension lead to any convenient ground.

## IGNITION SYSTEM

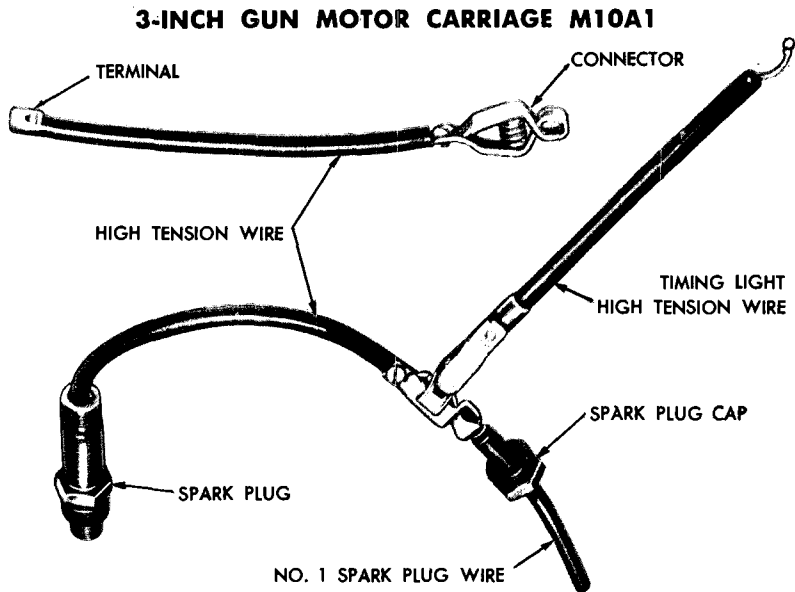


**Figure 33—Timing Light**

(3) **USE OF NEON TUBE TYPE TIMING LIGHT.** Start the engine and allow it to warm up. Set the engine idling speed at 500 revolutions per minute. Hold the timing light over the opening in flywheel housing so that it can flash on the timing marks (fig. 33). If the "SPARK SETTING" mark on the flywheel appears at the pointer, the timing is correct. If the "SPARK SETTING" appears to the left of the pointer, the timing is advanced; adjust magnetos (par. 47 a (4)). If the mark appears to the right of the pointer, the timing is retarded and should be adjusted (par. 47 a (4)). Repeat the above procedure for the second magneto.

(4) **ADJUSTING MAGNETOS TO CORRECT TIMING.** Remove the lock wire and loosen the upper and lower holding nuts on the magneto, and move the magneto in the housing slots toward the front (flywheel end of the engine) to advance the timing, or toward the rear to retard the timing. Recheck with timing light (par. 47 a (3)). After correct timing is obtained, tighten magneto holding nuts and secure with locking wire. Follow the same procedure in checking the timing and adjusting the second magneto. Check the magneto governor advance (par. 47 a (5)). Replace wires on spark plug and spark plug cover plates.

**NOTE:** If the timing is advanced or retarded more than 3 degrees or approximately one-half inch on the flywheel rim, it will be neces-



RA PD 28064

**Figure 34—Timing Light Connections**

sary to reset the timing by adjusting the magneto drive gear. Notify ordnance maintenance personnel.

(5) **CHECKING MAGNETO GOVERNOR ADVANCE.** Before attempting to check the magneto governor action, the initial timing must be established (par. 47 a (1) through (4)). With the timing light still connected, increase the speed of the engine, and observe the mark on the flywheel. The governor will start to advance when the engine speed reaches 600 revolutions per minute, and will be fully advanced when it reaches 1,400 revolutions per minute. The timing mark should move to the left of the pointer as the speed of the engine increases until the spark timing reaches maximum advance, at which time the flywheel mark will be approximately  $2\frac{5}{8}$  inches to the left of the pointer. If the timing mark does not change its position in relation to the pointer when the engine speed is increased, the magneto governor is faulty and should be replaced. Notify ordnance maintenance personnel.

#### 48. IGNITION SWITCH.

a. The operation of the ignition switch is described in paragraph 5 a (6). To replace the ignition switch, remove the instrument panel (par. 80 b). Remove the four bolts which hold the switch to the instrument panel and pull switch out through the back of the panel. Disconnect the right and left ignition wire. **NOTE:** As these wires are the same color, it will be necessary to tag each wire when removed.

## IGNITION SYSTEM



RA PD 27985

**Figure 35—Turning Engine by Hand**

To reinstall the ignition switch, reverse the sequence of the steps in the removal procedure.

### 49. SPARK PLUGS.

a. The spark plugs used are the aircraft type, Champion C88-S and are radio shielded. The distance between the electrodes of the spark plug when new should be 0.011 inch to 0.014 inch. Too wide a gap increases electrical resistance and interferes with the operation of the engine. Replace the plugs when the gap increases to 0.030 inch. To remove the spark plugs, remove the cover plate (figs. 17 and 18) over spark plug compartment, remove the retainer nuts and wires from spark plugs, and remove the spark plugs using spark plug wrench (41-W-3336-300), with handle (41-H-507-50). To reinstall spark plugs, reverse the sequence of the steps in the removal procedure.



**3-INCH GUN MOTOR CARRIAGE M10A1****50. SPARK PLUG WIRES AND CONDUITS (fig. 29).**

**a. General.** The wires leading from the magneto to the spark plugs may be identified for both right- and left-hand magneto by colors marked on the wires as follows: No. 1 red, No. 2 blue, No. 3 green, and No. 4 yellow. Spark plug wires, having cracked or damaged insulation, must be replaced as such wire may cause misfiring of the spark plug to which they are attached. If the flexible conduit becomes damaged or frayed out, it also must be replaced to avoid chafing of the spark plug wires.

**b. Replacement of Spark Plug Wires.**

(1) **REMOVAL.** To remove one or more spark plug wires, remove the spark plug cover plates (figs. 17 and 18), and remove the circular plate covering the spark plug wire terminals on the magneto (fig. 30). Remove the retainer nut from the spark plugs of the wires to be changed, and disconnect the terminals at the other end of the wires from the magneto. Attach a strong cord to the terminal at the magneto end of the wire and pull the wire out of the conduit. The cord is to be used later to pull a new wire through the conduit.

(2) **INSTALLATION.** Attach the cord described in preceding paragraph, and pull a new wire through the conduit. Attach spark plug retainer nut and fitting to end of the wire, and attach the wire to the spark plug. Attach the other end of the wire to the proper terminal on the magneto (fig. 30).

**c. Replacement of Flexible Conduit.** To remove flexible conduit, unscrew the knurled nut at each end of the flexible conduit. Remove the spark plug wires from the magneto and slip conduit from the wire. To reinstall flexible conduit, reverse sequence of the steps in the removal procedure. Use new gaskets at each end of the flexible conduit. Attach spark plug wires to the magneto in their proper order (fig. 30).

Section XIII

FUEL SYSTEM

	Paragraph
Fuel system .....	51
Carburetors .....	52
Degassers .....	53
Carburetor adapters .....	54
Air cleaners .....	55
Throttle controls .....	56
Priming pump .....	57
Fuel pump .....	58
Fuel filter .....	59
Fuel tanks .....	60

**51. FUEL SYSTEM.**

**a. Description.** The fuel system consists of two carburetors equipped with degassers, a fuel pump, four fuel tanks with fuel supply lines, a fuel filter, and a priming pump with supply lines to the intake manifolds. The total capacity of the fuel tanks is 192 gallons.

**b. Trouble Shooting.** Trouble shooting for the fuel system is covered in paragraph 36 e, f, i, j, in the engine section of this book.

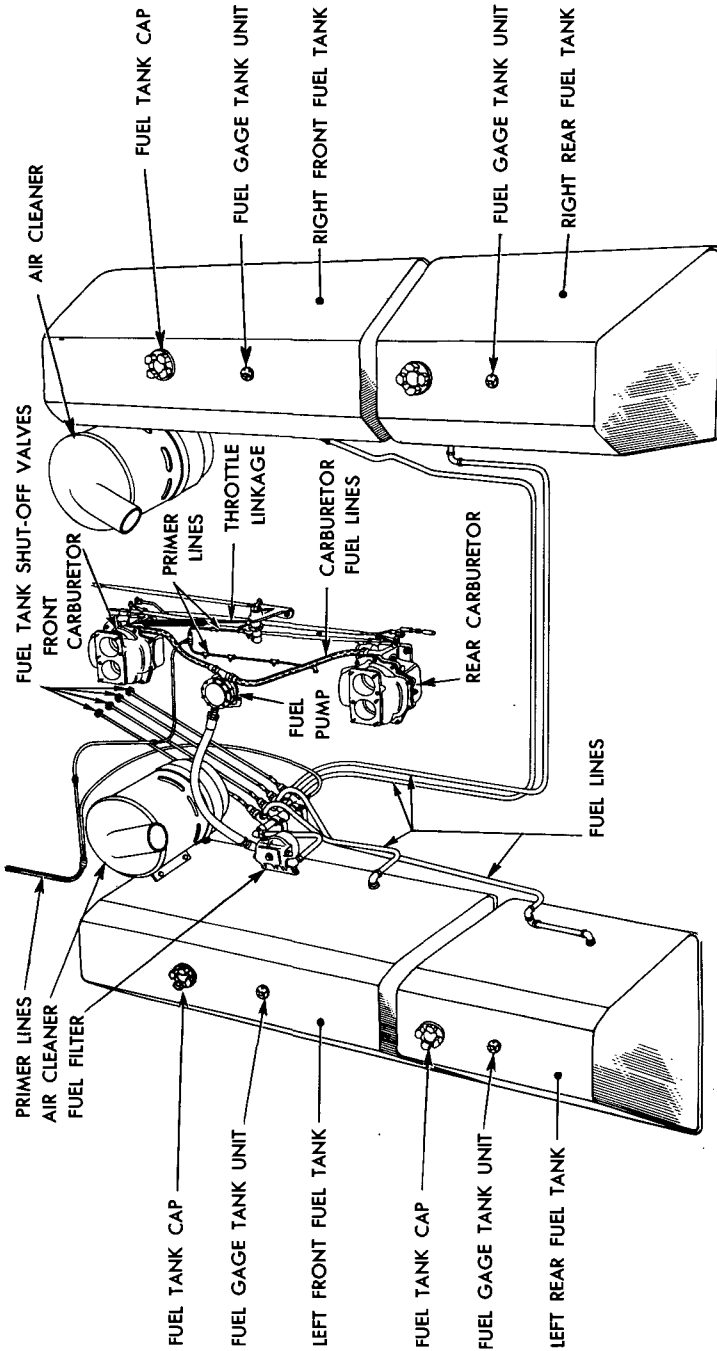
**52. CARBURETORS (fig. 37).**

**a. Description.** Two Stromberg Model NA-Y5G carburetors are used, mounted on carburetor adapters (figs. 19 and 20) connecting the two intake manifolds at each end. The carburetors are the dual (double-barrel) down-draft type. Each carburetor has two floats connected by one lever and operating on one needle valve. A separate main metering and idling system is provided for each barrel. Each barrel is equipped with a degasser (par. 53). An accelerating pump, which operates with the throttle, provides an extra quantity of fuel for rapid acceleration. The throttle linkage is arranged so that the forward carburetor remains closed until the rear carburetor is approximately half open (par. 56).

**b. Idle Fuel Adjustment.** Two idle fuel adjustment screws are provided on each carburetor, one for each barrel. The adjusting screws are shown in figure 37. The idle fuel adjustments on these carburetors are extremely uniform and can be adjusted when either cold or hot. Make the idle fuel adjustments with engine stopped. Turn each idle fuel adjusting screw (fig. 37) in (clockwise) until it seats lightly; then turn out one-fourth turn from the closed position. A stub (short) screwdriver will be required for making this adjustment on the forward carburetor.

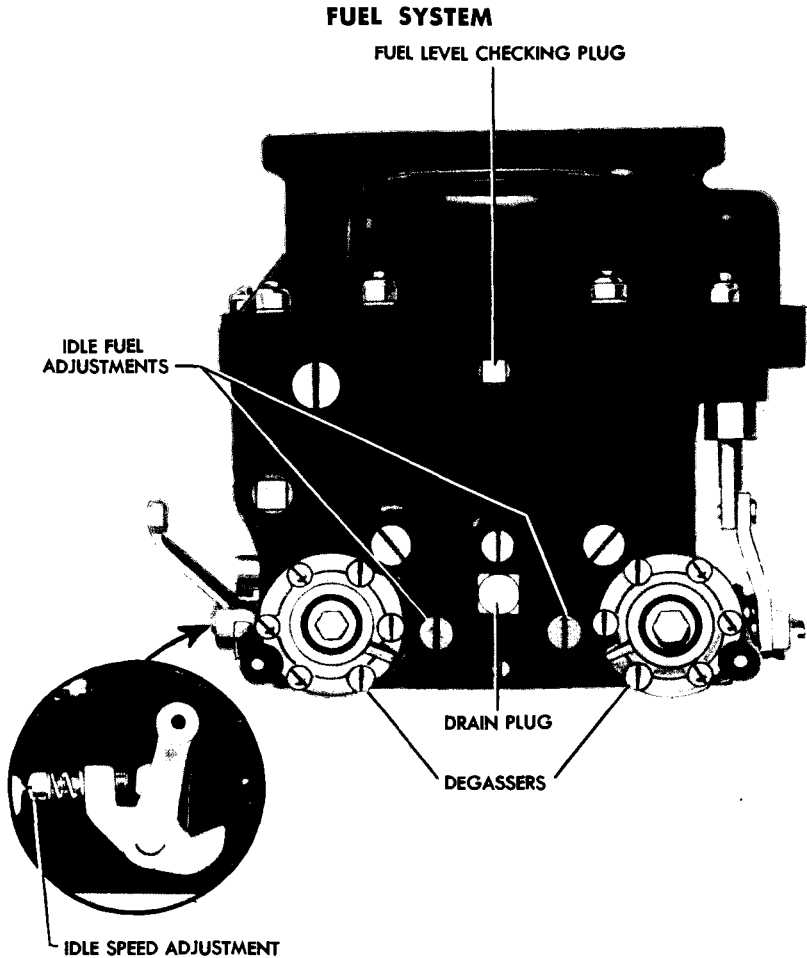
**c. Idle Speed Adjustment.** Start the engine and run until it reaches normal operating temperature. Back off the idle speed ad-

3-INCH GUN MOTOR CARRIAGE M10A1



RA PD 27698

Figure 36—Fuel System



RA PD 27408

**Figure 37 – Carburetor**

justment (fig. 37) at each carburetor until the engine idle speed is below 500 revolutions per minute. Set the idle speed adjustment at one of the carburetors until the engine idle speed is 500 revolutions per minute. Set the idle speed adjustment at the other carburetor until the engine speed just starts to increase; then back off the adjustment slightly.

d. **Fuel Level Check.** Each carburetor is provided with fuel level checking plugs (fig. 37), one at the front of the carburetor and one at the rear. To check the fuel level, remove the lock wire and the plug from the inspection hole in the front side of the rear carburetor, or the rear side of the forward carburetor. Start the engine and run at idling speed. The fuel should be visible at the bottom of the threads,

### 3-INCH GUN MOTOR CARRIAGE M10A1

of the inspection hole. If fuel is not visible, the fuel level is too low. If the fuel runs out of the inspection hole, the level is too high. In either case, carburetor should be replaced (par. 52 e).

#### e. Replacement.

(1) **REMOVAL OF EITHER CARBURETOR.** Remove the nuts at the top of each carburetor which attach the carburetor air intake manifold to the carburetors. Loosen the clamps at the two carburetor air intake manifold tubes, and remove the tubes from the manifold. Remove the carburetor air intake manifold. Disconnect the carburetor fuel feed line at the fuel pump. Disconnect the degasser electrical connections on the carburetor. Remove the four carburetor base nuts holding the carburetor to the adapter. Disconnect the throttle rod from the "ball" joint at the carburetor and remove the carburetor.

f. **Installation.** Reverse the sequence of the steps in the removal procedure.

### 53. DEGASSERS (fig. 37).

a. **Description.** Each barrel of both carburetors is equipped with a vacuum-operated degasser and an electrical control for positive shut-off of the idle fuel mixture when stopping the engine. All fuel flowing through the idle discharge holes must pass through the degasser needle valve seat. The purpose of the degasser is to shut off the idle fuel supply when high manifold vacuum is present during deceleration to prevent flame and backfire through the exhaust. The electric fuel cut-off portion of the degasser works independently of the vacuum-operated portion although it is in the same assembly and operates the same needle valve. A solenoid built into each degasser closes the needle valve when the fuel cut-off button on the instrument panel is pressed. The purpose of the fuel cut-off is to shut off the idle fuel mixture just before stopping the engine to prevent the fuel from reaching the cylinders and prevent the engine from continuing to run on preignition after the ignition switch has been turned off.

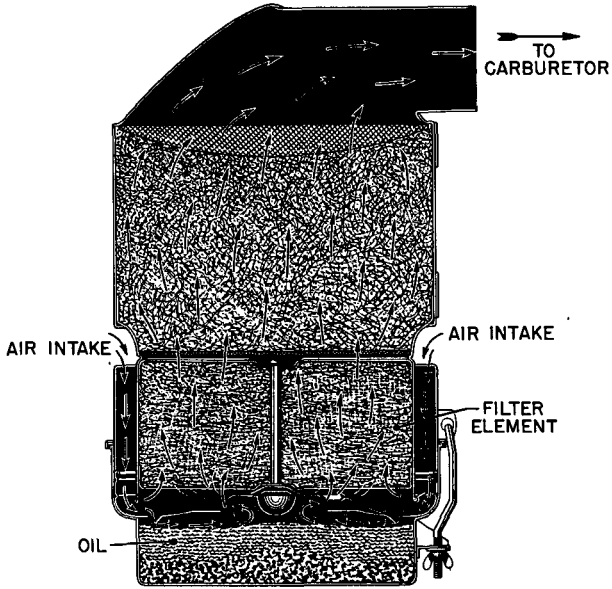
b. **Replacement.** To remove the degasser, pull the degasser wire out of its terminal socket. Remove the lock wire and the three screws which hold the degasser to the carburetor and remove the degasser. To install the degasser, reverse this procedure.

### 54. CARBURETOR ADAPTERS (figs. 19 and 20).

a. **Description.** A carburetor adapter is connected to each end of the intake manifolds. These adapters are also connected to the exhaust manifolds by heater pipes which heat the fuel air mixture as it comes from the carburetors. These adapters each contain two throttle plates operated by the engine speed governor (par. 39 a).

b. **Replacement.** Remove the heater pipe (par. 41 b (2) (a)).

FUEL SYSTEM



RA PD 27277

**Figure 38—Air Cleaner—Section**

Remove the carburetor (par. 52 e). Disconnect the clevis at the end of governor throttle rod. When removing the rear adapter, disconnect the ball joint at the governor arm. Remove the six nuts which hold the adapter to the manifold. Remove adapter. To install the carburetor adapter, reverse the sequence of the steps in this procedure.

**55. AIR CLEANERS (fig. 38).**

**a. Description.** Two air cleaners of the oil bath type are located one at the right side, and one at the left side of the engine compartment mounted on the bulkhead.

**b. Maintenance.** Remove the three wing nuts from the bottom plate of the cleaner, and remove the baffle and cup assembly. Remove the filter element by pulling the clip down. Wash the filter element with dry-cleaning solvent. Dry and blow out with compressed air in reverse direction to normal air travel. Clean and refill the cup to proper level with oil specified (section VI). Care should be taken not to fill the cup above the oil level mark. Place the cup assembly on cleaner and fasten with the three wing nuts. Check carburetor air manifold tube connections for leaks.

**c. Replacement.** Disconnect the air tube connections at carburetor air intake manifold and air cleaners. Remove the tubes. Re-

3-INCH GUN MOTOR CARRIAGE M10A1

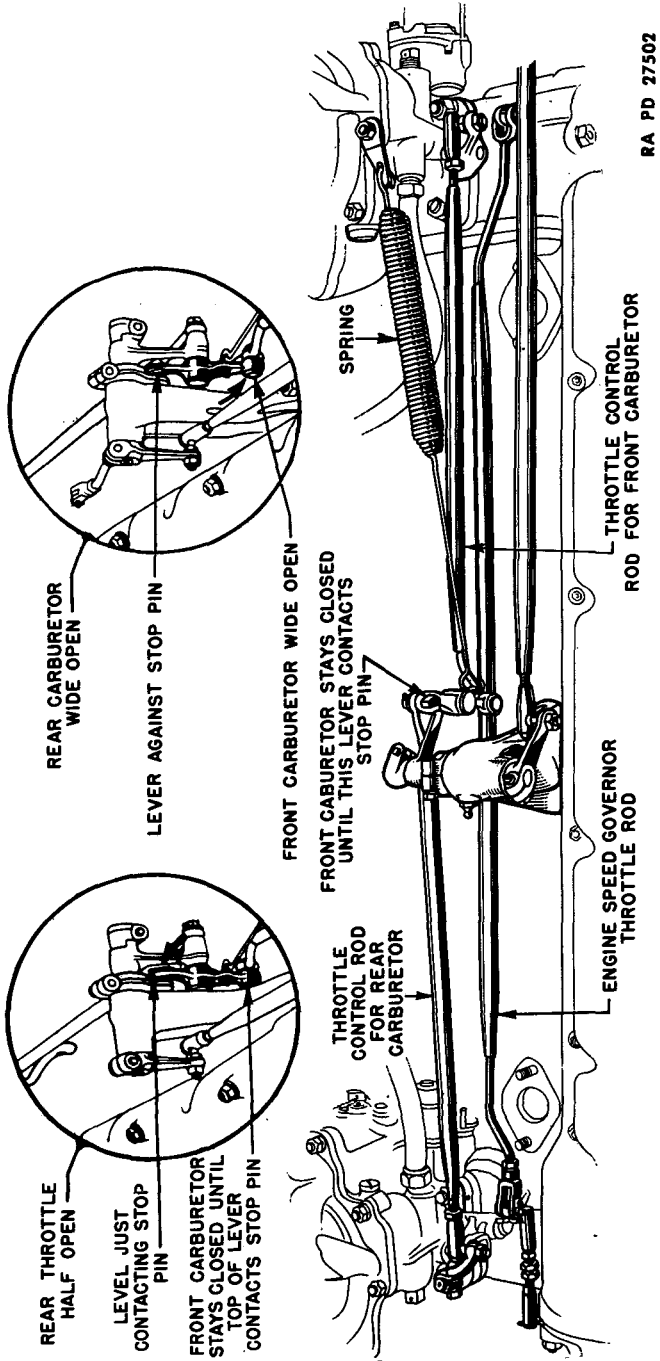


Figure 39 — Throttle Linkage

## FUEL SYSTEM

move the cup from the cleaner. Remove the four cap screws which hold the mounting band and remove the cleaner. To install the air cleaner, reverse the sequence of the steps in this removal procedure.

### 56. THROTTLE CONTROLS.

a. **General.** The carburetor throttle control linkage as shown in figure 39 is arranged so that throttle plates of the rear carburetor open to approximately half throttle before the forward carburetor throttle plates start to open. The rate of opening of the throttle plates in the forward carburetor is approximately twice as fast as for the rear carburetor with the result that both reach the wide open point together.

b. **Adjustment.** To adjust the throttle linkage for the proper throttle opening, the ball and socket joint on each throttle control rod (fig. 39) is screwed on the rod to attain a length of  $16\frac{5}{8}$  inches for each rod, measured from the center of the ball to the center of the pin hole at the other end of the rod. Adjust the length of the rod connecting between the lever at the center bracket and the cross shaft on the bulkhead to attain a length of 23 inches, measuring from the end of the ball joint to the end of the ball joint at the other end of the rod. After all control rods are connected, adjust the dog on the inner end of the cross shaft (center bracket) so that the rear carburetor will start to open with a slight movement of the throttle rod.

#### c. Hand Throttle.

(1) **DESCRIPTION.** The hand throttle mounted on the power train housing (fig. 7) is connected to the carburetor control through rods and three cross shafts. One cross shaft is located at the rear of the driver's seat, one at the clutch housing, and one on the rear side of the bulkhead. The rear of the throttle cable is connected to the foot throttle through a slip connection which allows either foot or hand throttle to be operated independently of each other.

(2) **REPLACEMENT.** Loosen the lock nut at the bottom of the hand throttle bracket, and remove the cable and conduit from the bracket. Remove the screws from the driver's compartment subfloor and remove the floor. Remove rear nut from hand throttle conduit where it is attached to the cross member. Remove adjusting nut and spacer from rear end of throttle cable and remove conduit and cable. To reinstall the hand throttle, reverse the sequence of the steps in the removal procedure.

(3) **ADJUSTMENT.** Adjust the nut on the rear of hand throttle cable at the foot throttle cross shaft lever so that the throttle button has approximately  $\frac{1}{4}$ -inch free movement.

#### d. Foot Throttle.

(1) **DESCRIPTION.** The foot throttle pedal (fig. 7) is connected to the carburetor control through the same rods and three cross shafts used with the hand throttle.



### **3-INCH GUN MOTOR CARRIAGE M10A1**

(2) **REPLACEMENT.** Remove the screws from the driver's compartment subfloor and remove the floor. Remove the lock wire and bolt from the bracket at the base of the throttle pedal, also remove the clevis pin from the rod connecting the pedal to the cross shaft at the rear of the driver's seat. Remove the pedal. To install the foot throttle pedal, reverse the sequence of the steps in the removal procedure.

e. **Governor Control.** The operation of the governor which controls and limits the engine speed through additional throttles in the carburetor adapters is described in paragraph 39 a. Adjustment of governor throttle control rod is outlined in paragraph 39 a.

#### **57. PRIMING PUMP.**

a. **Description.** The operation of the priming pump located on the front bow in driver's compartment (fig. 7) is described in paragraph 5 b (4).

b. **Replacement.** Disconnect the inlet and outlet gasoline lines at the priming pump. Remove the two cap screws from each side of the priming pump bracket and remove the priming pump. To reinstall, reverse the sequence of the steps in the removal procedure.

#### **58. FUEL PUMP.**

a. **Description.** The fuel pump is of the conventional diaphragm type (AC) and is mounted on the left-hand cylinder head (fig. 18). The pump is driven by the left intake camshaft. The pump maintains from 4½ to 6 pounds fuel pressure in the carburetors.

b. **Service and Test.** At each inspection, the pump should be checked for leaks at connections, and for tightness of screws on top of pump. To test the fuel pump, disconnect fuel line at either outlet connection at the pump, and attach a fuel pressure gage. Using the starter, crank the engine. The fuel pressure should be between 4½ and 6 pounds. Low pressures will starve the carburetor under full load. High pressures will cause a high fuel level in the carburetor float bowl.

c. **Replacement.** Close the fuel shut-off valves (fig. 9). Disconnect the inlet and outlet fuel line connections at the pump. Remove the two nuts which secure pump to cylinder head and remove the fuel pump. To install the fuel pump, reverse the sequence of the steps in this removal procedure. **NOTE:** Approximately 20 seconds are required for a dry fuel pump to supply fuel while engine is being cranked with the starter.

#### **59. FUEL FILTER.**

a. **Description** (fig. 40). The filter assembly consists of a stack-type disk element and a metal filter bowl located on left side of the engine compartment. Inlet and outlet passages are marked "IN" and

FUEL SYSTEM

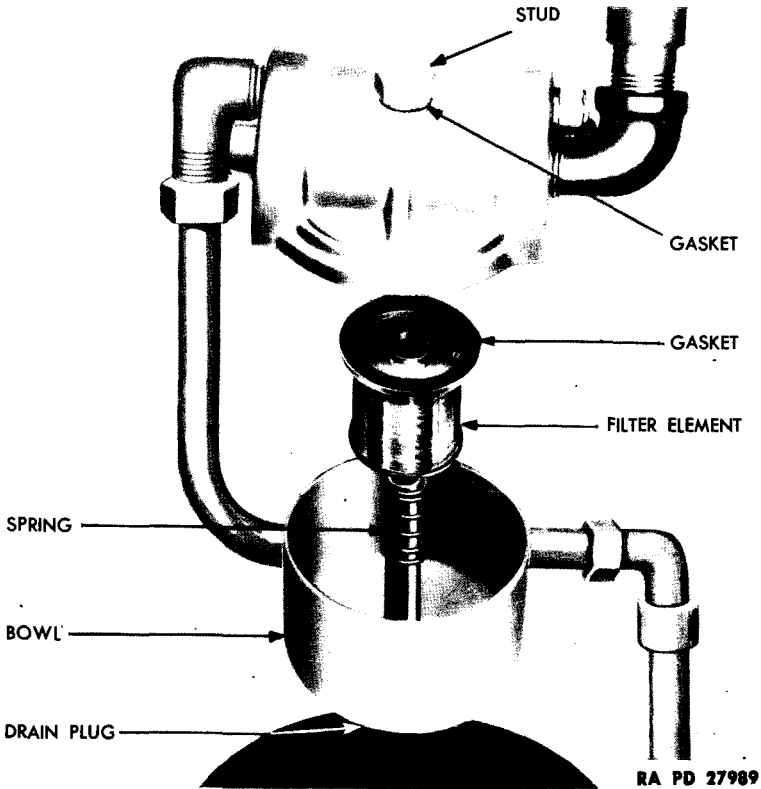


Figure 40—Fuel Filter

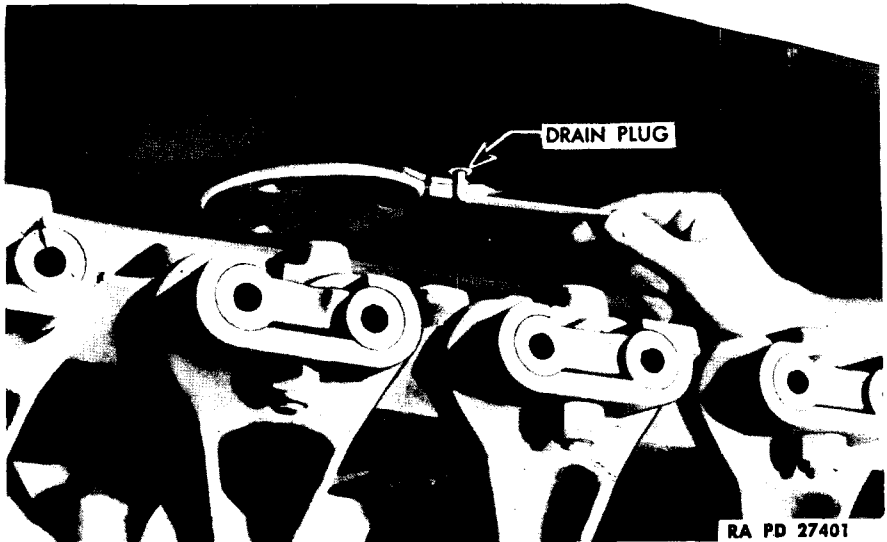
“OUT”. The filter element consists of a large number of filter disks (0.020 in. thick) stacked and squeezed together.

b. **Drain.** Close the fuel shut-off valves and remove the drain plug at the bottom of the filter bowl to remove accumulated dirt and water.

c. **Clean Filter Element** (fig. 40). Remove the center stud at the top of the filter. Remove and clean the bowl and wash the filter element in dry-cleaning solvent. Care must be taken to prevent damage to the disks. Do not scrape or scrub the disks. Do not attempt to disassemble the filter element; replace element if it cannot be cleaned satisfactorily. Before replacing filter bowl, inspect and replace the gasket if necessary.

d. **Replacement of Filter Assembly.** To remove the filter assembly, close the fuel shut-off valves (fig. 9). Disconnect the filter outlet pipe at the fuel pump and disconnect fuel pipe from the filter. Dis-

3-INCH GUN MOTOR CARRIAGE M10A1



*Figure 41—Fuel Tank Drain Plug*

connect the inlet pipe connection at the filter. Remove the two cap screws which hold the filter to the fire wall. Remove the filter. To reinstall, reverse the sequence of steps in the removal procedure.

**60. FUEL TANKS.**

a. **Location and Capacity.** Four horizontal fuel tanks are provided. Two are located in the engine compartment right sponson and two in the left sponson. The capacity of the right and left rear tanks is 39½ gallons each. The capacity of the right front tank is 58 gallons. The capacity of the left front tank is 55 gallons.

b. **Draining Fuel Tanks.** The drain plug for the right front tank is located on the bottom of the right sponson just above the rear bogie track support wheel. The drain plug for the left front tank is located in a similar position on the bottom of the left sponson. The drain plug for the right rear tank is located on the bottom of the right sponson above the track idler wheel. The drain plug for the left rear tank is located in a similar position on the bottom of the left sponson. To remove any of the four drain plugs, proceed as follows: Remove two screws from the round plate on the bottom of the sponson and loosen the third screw. Swing the round plate out of the way (fig. 41). Remove the drain plug.

c. **Replacement of Right Front Tank.**

(1) **REMOVAL.** Drain the tank (par. 60 b). Disconnect the fire extinguisher line connections at nozzles, and remove the lines which

## FUEL SYSTEM

are in front of the fire wall. Disconnect the fuel line and remove fuel line elbow from the tank. Disconnect radiator vent pipe at the radiator and at the expansion tank, remove the holding clips, and remove the pipe. Remove the cap screws and nuts which hold the fire wall to the sponson and remove the fire wall. Remove the bolt from each hold-down strap. Remove the filler cap. Move the tank part way out and disconnect fuel level gage wire from tank float. Remove the tank.

(2) **INSTALLATION.** Reverse the sequence of the steps in the removal procedure.

**d. Replacement of Left Front Tank.** Follow the sequence of the steps for the removal of the right front tank (par. 60 c) and in addition remove the fuel filter (par. 59 d) and the expansion tank (par. 69 b). To reinstall the left front tank, reverse the sequence of the steps of this removal procedure.

**e Replacement of Right or Left Rear Tank.**

(1) **REMOVAL.** Drain the tank (par. 60 b). Remove the front tank (par. 60 c). Disconnect the fuel line at the tank, and remove the fuel line elbow from the tank. Remove the fan and shroud assembly (par. 66 d). Remove upper radiator baffle (par. 64 b). Remove the cap screws and nuts which hold the fire wall to the sponson and remove the fire wall. Remove the cap screws which hold the rear inspection plate to the sponson and remove the plate. Remove bolt from each hold-down strap. Remove the filler cap. Move the tank forward, and disconnect the fuel level gage wire from the tank float. Remove the tank.

(2) **INSTALLATION.** Reverse the sequence of the steps in the removal procedure.

**f. Fuel Tank Shut-off Valves.** A shut-off valve for each tank is located in the left side of the engine compartment with controls in the fighting compartment on the forward side of the bulkhead (fig. 9).

3-INCH GUN MOTOR CARRIAGE M10A1

Section XIV

COOLING SYSTEM

	Paragraph
Cooling system .....	61
Antifreeze .....	62
Corrosion inhibitor .....	63
Radiator .....	64
Water pump .....	65
Fans .....	66
Accessory drives .....	67
Thermostat .....	68
Expansion tank and filler .....	69

61. COOLING SYSTEM.

a. **General Description** (fig. 42). The engine is cooled by circulation of water through the water jackets which extend the full length of the cylinder bores. The water is circulated through the engine block and radiator by a centrifugal pump (par. 65).

b. **Cooling System Seal.** The entire cooling system is sealed by means of a pressure filler cap which remains closed until a pressure of 12 pounds is reached. This results in raising the boiling point of the water, thus reducing loss of water or antifreeze. An expansion tank permits steam or antifreeze vapors to condense and return to the cooling system further reducing the loss of water or antifreeze.

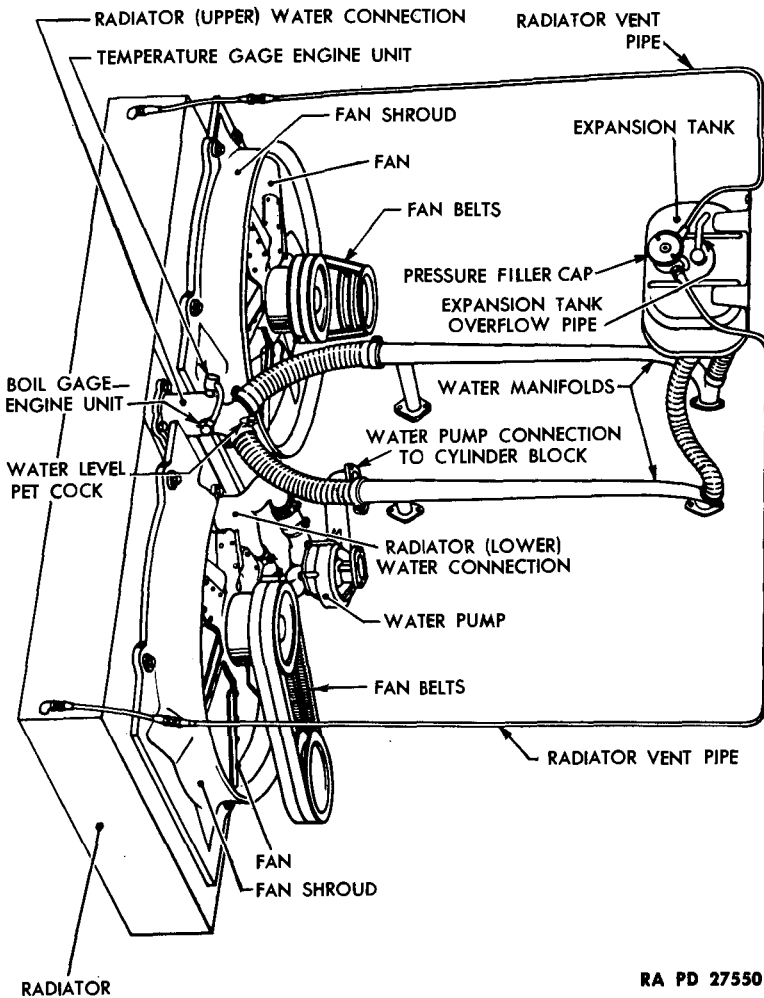
c. **Capacity.** The capacity of the entire cooling system is 17 gallons.

d. **Maintenance.** Always use clear water, preferably rain or soft water if possible. Do not put cold water into the system when the engine is hot. The radiator and cooling system should be drained, flushed, and refilled with clean water and corrosion inhibitor added (par. 63) at each 1,000 mile inspection (par. 33 a (5)). A drain plug is provided at the bottom of the water pump (fig. 21). The expansion tank is provided with a drain plug (fig. 47). A drain plug at the rear of each bank of cylinders located approximately 6 inches ahead of the engine rear mounts (figs. 17 and 18), is provided for draining the water from the cylinder block. **NOTE:** On earlier production engines the cylinder block drain plugs are located at the engine rear mounts (fig. 43).

62. ANTIFREEZE.

a. High boiling point permanent antifreeze solutions or alcohols are satisfactory as antifreeze solutions. However, a corrosion inhibitor must be used, preferably as part of the antifreeze.

**COOLING SYSTEM**



RA PD 27550

**Figure 42—Cooling System**

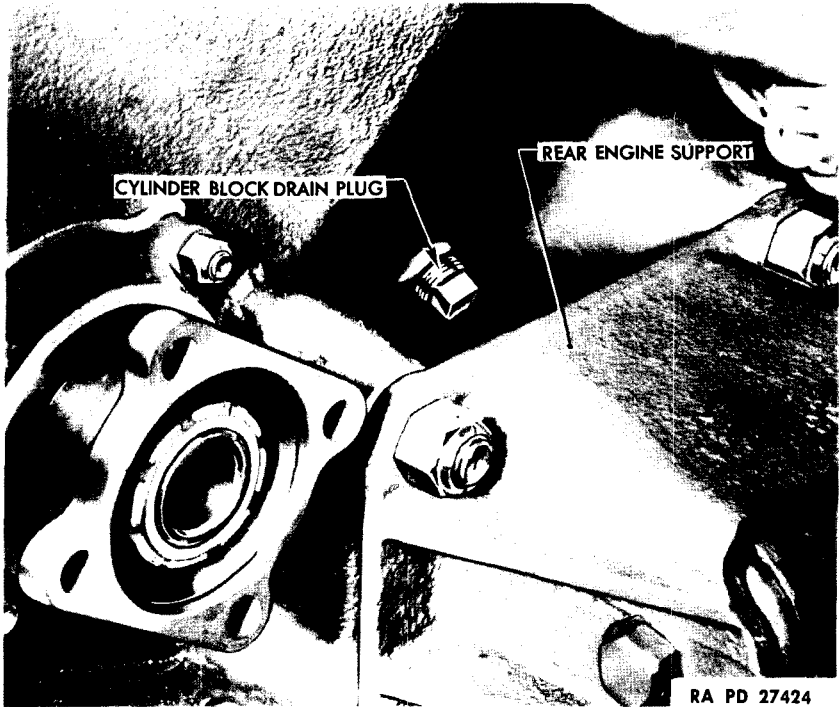
**63. CORROSION INHIBITER.**

a. To control rusting of the iron in the cooling system and the corrosion of the aluminum cylinder block and cylinder heads, a soluble oil corrosion inhibitor must be used. It is important when the cooling system is refilled with fresh water after draining, especially when antifreeze is not being used, that 14 ounces of this inhibitor be added to the water.

**64. RADIATOR.**

a. **Description.** The radiator is of the tube and fin cross-flow

## 3-INCH GUN MOTOR CARRIAGE M10A1



**Figure 43—Engine Block Drain Plug**

type, using flat horizontal tubes. The hot water flows through the tubes to which are attached thin vertical copper fins. Air forced between these fins by the fans carries the heat away, thus cooling the water.

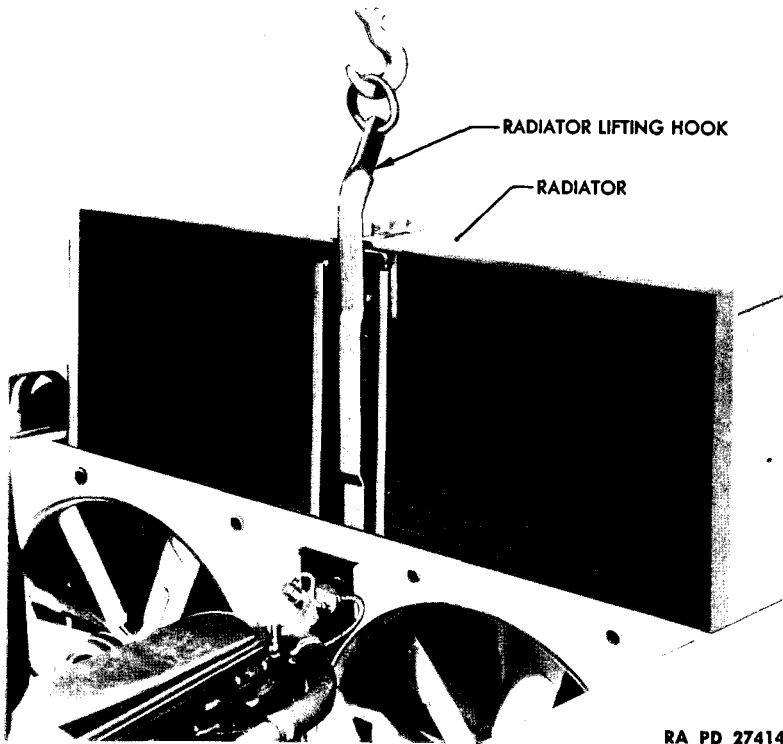
**b. Replacement.**

**(1) REMOVAL OF RADIATOR.**

*(a) Preliminary Work.* Open the engine compartment doors. Remove the three cap screws which hold the rear door of the engine compartment closed. Raise the radiator air baffle and allow it to rest on top of the engine compartment rear door after the door is all the way open. Remove the cap screws which secure the engine compartment rear cover plate to the hull and lift the cover from the hull with a chain fall or hoist (fig. 25). Remove the four bolts which secure the radiator hold-down plate to the fan shrouds and remove the plate. Remove the plug at the bottom of the water pump (fig. 21) and drain the cooling system. Loosen hose clamps, and remove the radiator upper hose and radiator to water pump hose.

*(b) Remove Radiator Upper and Lower Water Connections.* Remove the four cap screws from the radiator upper and lower water connections, and remove the connections.

## COOLING SYSTEM



**Figure 44—Radiator Removal**

(c) *Remove Upper and Lower Radiator Baffles and Disconnect Vent Pipes.* Remove one bolt on each end which holds the lower air baffle and remove baffle. **CAUTION:** The air baffle can be rested on top of the engine compartment rear door to take some of the weight off the bolts; however, to remove the baffle requires two men, one at each end to hold baffle up as bolts are removed so that it can be lowered gradually. Remove one bolt at each side of the upper radiator air baffle located at the top rear of the radiator, and remove through the opening below baffle. Disconnect both ends of the short length of each vent pipe at the top of the radiator and remove the pipes.

(d) *Remove Radiator.* Connect radiator lifting hook and carefully pull out radiator (fig. 44), using a chain fall or hoist.

(2) **INSTALLATION OF RADIATOR.** To install the radiator, reverse the sequence of the steps in the removal procedure.

### 65. WATER PUMP.

a. **Description** (fig. 21). The water pump is a centrifugal type driven by a splined shaft from the rear of the crankshaft.



### **3-INCH GUN MOTOR CARRIAGE M10A1**

**b. Lubrication.** The water pump is lubricated from the engine and a permanent water seal is used; therefore, no attention is required.

**c. Replacement.**

(1) **REMOVAL.** Open the rear door of the engine compartment (par. 64 b (1) (a)). Remove the plug at the bottom of the water pump (fig. 21) and drain the cooling system. Loosen the hose clamps, and remove the two hose running from the radiator to the water pump. Remove the four nuts which hold the water pump to the crankcase, two at center connection and two at water connection at the left, and remove the pump.

**d. Installation of Water Pump.** To install the water pump, reverse the sequence of the steps in the removal procedure, using new gaskets and water hose connections if necessary.

### **66. FANS.**

**a. Description.** Two 26-inch diameter six-blade blower or pusher-type fans are used. They are mounted in the front of the radiator. The fans draw air in through the openings in the engine compartment doors and force the air out through the radiator and air baffles back of the radiator. Each fan is driven by two matched V-belts (fig. 45) from pulleys on the accessory drive housings (mounted on the sides of the hull toward the rear of the engine compartment).

**b. Fan Belt Replacement or Adjustment (fig. 45).** Replacement or adjustment of the fan belts is made by moving the accessory drive housing up or down in slots provided after loosening the four nuts which secure the housing to the hull sides. The belts are correctly adjusted when approximately 1-inch movement can be obtained with the fingers at a point midway between the fan and accessory drive pulleys (fig. 45). **NOTE:** When replacement of belts is made, always replace both belts running on the same pulleys.

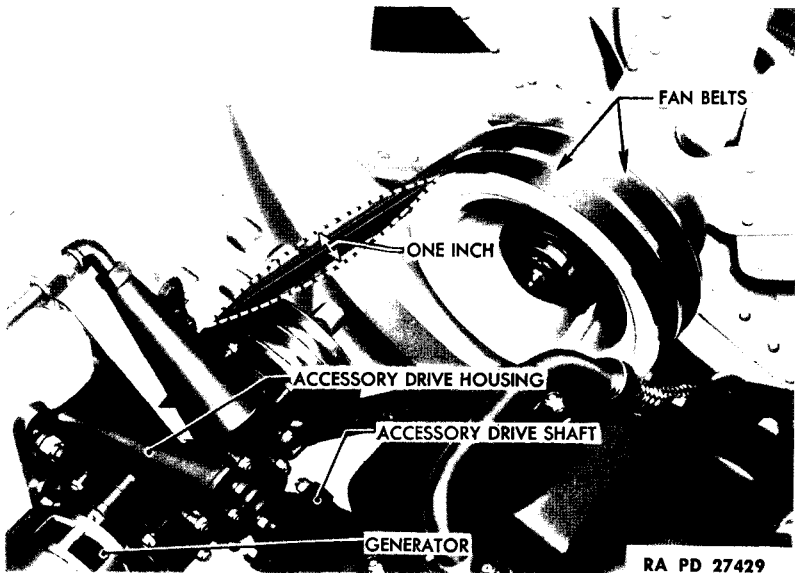
**c. Fan Bearing Lubrication.** The fan bearings are packed when assembled and should require no further lubrication between overhaul periods.

**d. Replacement of Fan and Shroud Assembly (fig. 22).** To remove fans and shrouds, open the engine compartment doors and remove the engine compartment rear cover plate (par. 64 b (1) (a)). **NOTE:** It is not necessary to remove the engine compartment doors. Loosen and remove the fan belts (par. 66 b). Remove the two bolts and four cap screws from each fan shroud and remove the assemblies. To reinstall, reverse the sequence of the steps in the removal procedure.

**e. Replace Fan Bearings.**

(1) **REMOVAL.** Remove fan and shroud assembly (par. 66d). Remove the six cap screws from the fan hub and remove the pulley and fan blades. Bend up the ear of the lock washer from the slot in the

COOLING SYSTEM



**Figure 45—Fan Belt Adjustment**

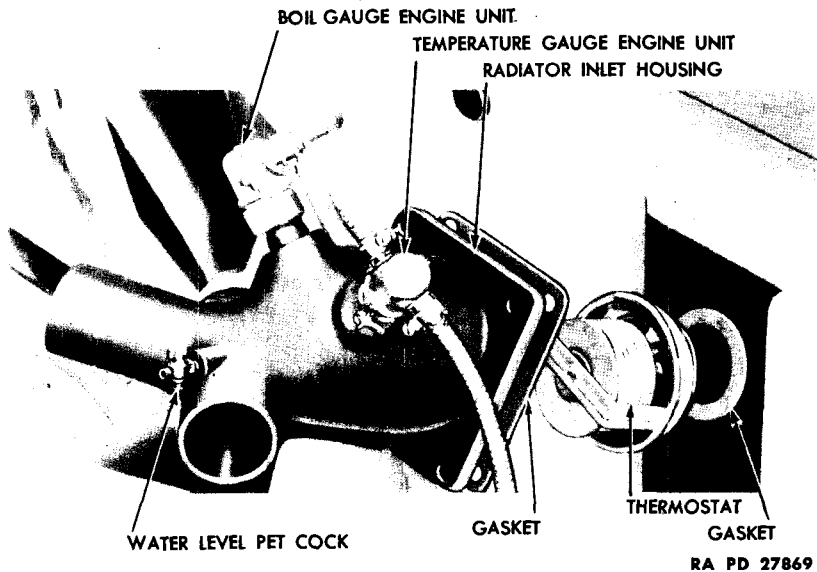
round nut at the front of fan shaft and remove the nut with a spanner wrench. Remove shaft and hub from the shroud. Remove the round nut at rear of shaft in the same manner as outlined for removing front nut; then tap out shaft using a soft hammer (lead, copper, or rawhide). Tap the front bearing from the hub with a brass drift and remove the two spacers. Remove the lock ring and tap out the rear bearing with a brass drift.

(2) **INSTALLATION.** To install the fan bearings, reverse the sequence of the steps in the removal procedure. Make certain that both bearings are packed with lubricant before assembling.

**67. ACCESSORY DRIVES.**

a. **Description.** The accessory drives are located on the right and left walls of the engine compartment to the rear of the engine. These accessory drives contain bevel gears running in engine oil which transmit the power from the engine accessory shafts to drive the generators and fans. The accessory drives are provided with bayonet type oil level gages, which are a part of the filler plugs.

### 3-INCH GUN MOTOR CARRIAGE M10A1



**Figure 46—Thermostat**

#### **b. Replacement.**

(1) **REMOVAL.** Remove the accessory drive shaft (par. 37 a (12)). Remove the generator (par. 72 c). Loosen the four nuts securing the accessory drive housing to the hull, and lift the assembly so that the fan belts can be removed from the pulleys. Take off the nuts and remove the accessory drive assembly from the hull. **NOTE:** The above procedure applies to either the right or left accessory drive.

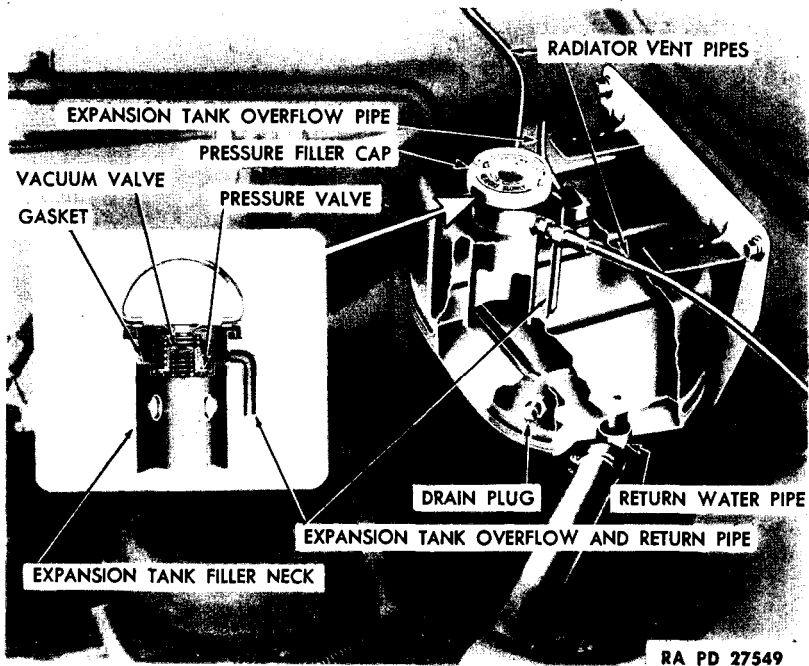
(2) **INSTALLATION.** Reverse the sequence of the steps in the removal procedure.

#### **68. THERMOSTAT.**

**a. Description** (fig. 46). The thermostat located in the inlet opening of the radiator is of the bypass bellows type and is nonadjustable. This thermostat prevents the circulation of water in the radiator until the engine reaches normal operating temperature. The thermostat starts to open at 140 F.

**b. Replacement.** Open the engine compartment doors. Remove drain plug at bottom of water pump (fig. 21) and drain out enough water (approximately 2 gallons) so that the level is below the thermostat. Remove the four cap screws from radiator upper water connection. Loosen hose clamps from both radiator upper hose at the engine and at the thermostat housing. Remove the hose. Remove the water connection and the thermostat from the radiator (fig. 46). To install, reverse the sequence of the steps in the removal procedure, installing new gaskets if required.

COOLING SYSTEM



**Figure 47—Radiator Filler and Expansion Tank**

**69. EXPANSION TANK AND FILLER (fig. 47).**

**a. Description.** The expansion tank, located on the bulkhead at the front of the engine, catches the water or steam that may be forced out of the cooling system. When a sufficient pressure (12 lb) is built up in the cooling system due to expansion of the coolant, the pressure valve in the filler cap opens, and the excess water or steam goes into the expansion tank. As the engine cools, a vacuum is formed in the sealed cooling system drawing water back into the cooling system again through a vacuum valve in the pressure cap (fig. 47).

**b. Replacement.** Drain out enough water (approximately 2 gallons) so that level is below the expansion tank. Remove the left air cleaner to intake manifold tube. Loosen the hose clamps at the bottom of the expansion tank. Remove the four cap screws which hold the expansion tank bracket to the bulkhead. Lift up expansion tank and remove the two water hose from the bottom of the tank. Remove the tank. To install, reverse the sequence of the steps in the removal procedure.

**c. Drain Expansion Tank.** To drain the expansion tank, remove the drain plug on the right side of tank (fig. 47).

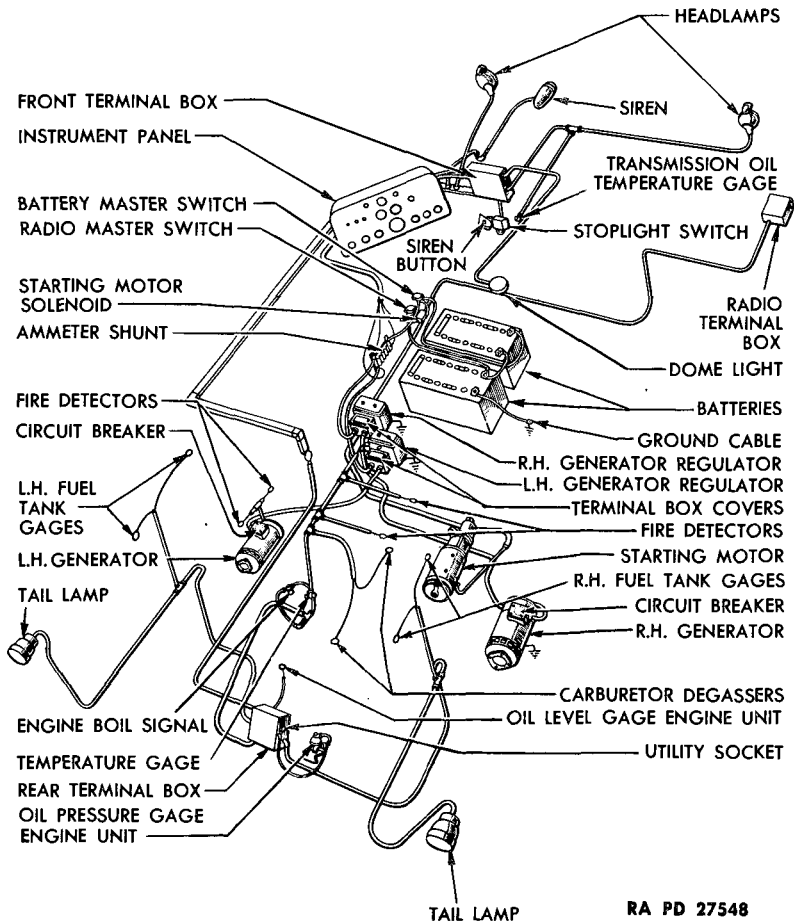
## 3-INCH GUN MOTOR CARRIAGE M10A1

## Section XV

## ELECTRICAL SYSTEM AND EQUIPMENT

	Paragraph
General description . . . . .	70
Generating system . . . . .	71
Generators . . . . .	72
Generator circuit breaker . . . . .	73
Generator regulator . . . . .	74
Generator filter . . . . .	75
Battery . . . . .	76
Starting system . . . . .	77
Starter . . . . .	78
Starter solenoid . . . . .	79
Instrument panel . . . . .	80
Circuit breakers . . . . .	81
Fuel cut-off switch . . . . .	82
Utility outlet sockets . . . . .	83
Ammeter . . . . .	84
Ignition switch . . . . .	85
Voltmeter . . . . .	86
Blackout driving light switch . . . . .	87
Starter button . . . . .	88
Light switch . . . . .	89
Fire detector signal . . . . .	90
Instrument panel lights . . . . .	91
Transmission oil temperature gage . . . . .	92
Oil level gage . . . . .	93
Low oil pressure signal . . . . .	94
Engine boil signal . . . . .	95
Engine temperature gage . . . . .	96
Fuel level gage . . . . .	97
Fuel level gage selector switch . . . . .	98
Panel light rheostat switch . . . . .	99
Battery master switch . . . . .	100
Radio master switch . . . . .	101
Headlights . . . . .	102
Taillights . . . . .	103
Stop light switch . . . . .	104
Compartment light . . . . .	105
Inspection light . . . . .	106
Siren . . . . .	107
Conduits and wires . . . . .	108
Trouble shooting . . . . .	109
Wiring . . . . .	110

**ELECTRICAL SYSTEM AND EQUIPMENT**



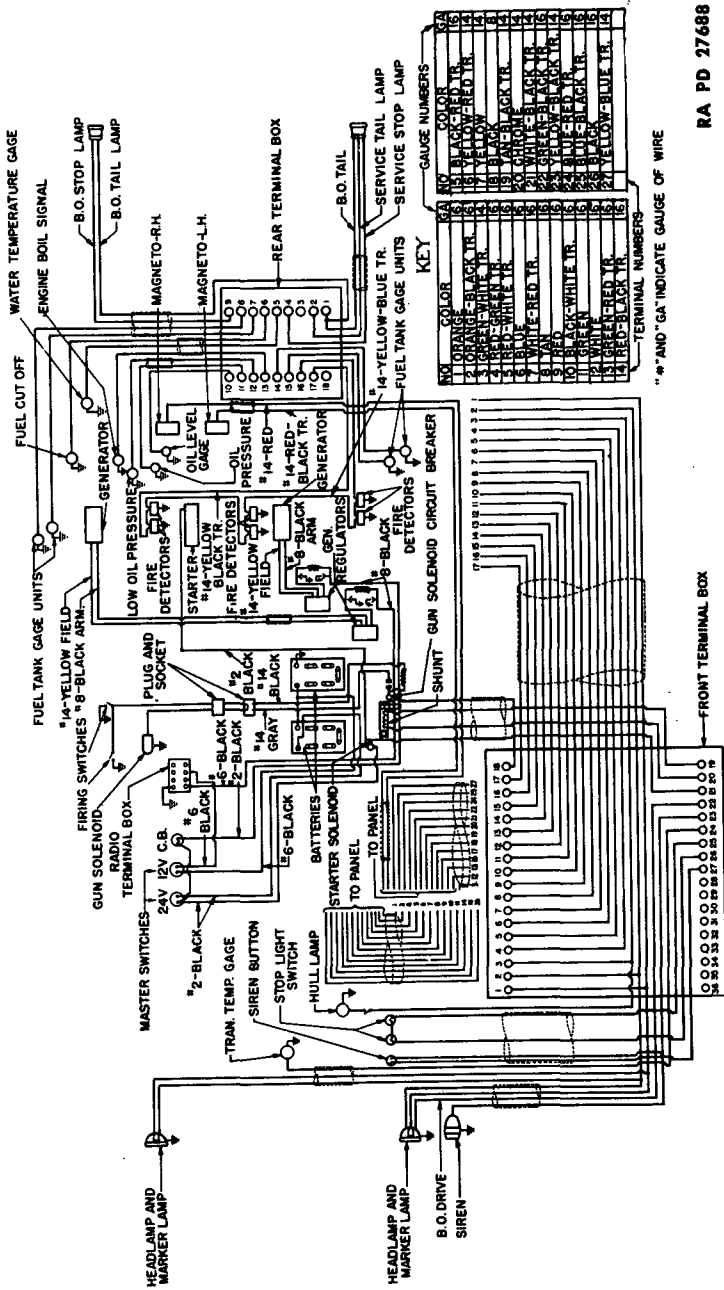
RA PD 27548

**Figure 48—Electrical System**

**70. GENERAL DESCRIPTION.**

a. The Gun Motor Carriage M10A1 uses a 24-volt electrical system. All units of the electrical system are designed for 24-volt operation with the exception of the blackout driving lamps. The blackout driving lamp circuit includes a resistance (fig. 55) that permits the use of 6-volt bulbs. Figure 48 shows the location of each of the units of the electrical system with regard to other units. The electrical system consists of: the generating system (par. 71), the starting system (par. 77), the electrical instruments (pars. 80 through 99), and the light and siren circuits (pars. 102 through 107). General discussions that apply to the entire electrical system are given in paragraphs 70,

3-INCH GUN MOTOR CARRIAGE M10A1



RA PD 27688

Figure 49 - Wiring Diagram

## ELECTRICAL SYSTEM AND EQUIPMENT

100, 101, 108, 109, and 110. Figure 49 is a wiring diagram of the entire vehicle. Figure 54 is a wiring diagram of the instrument panel.

### 71. GENERATING SYSTEM.

a. **Description.** As shown in figure 50, the generating system consists of generators (par. 72), the generator regulators (par. 74), the battery (par. 76), and the various connecting wires (fig. 50). The entire system, including the ground circuit, must be considered in the event of failure.

b. **Ground Circuit.** The path of the current from the generator to the battery through ground is of equal importance with the other side of the circuit. The ground circuit includes the battery ground cable, the contact between the accessory drive housing and the hull, and the contact between generator flange and the accessory drive housing. All of these surfaces of contact must be clean and free from paint to assure good electrical connection. Abnormal electrical resistance at any of these points will cause a reduction in the generator output, and prevent the generator from being fully charged.

#### c. Armature Brush to Battery Circuit.

(1) **GENERAL.** The path of the current from the generator armature brush to the battery passes through the generator regulator, including the cut-out points. Any extra resistance in the circuit will result in limiting the generator before the battery is fully charged. If the generator regulator is not properly grounded, the cut-out will not close, and the generator cannot charge the battery; therefore, the resulting excessive generator field current may destroy the generator.

(2) **CIRCUIT BREAKERS.** If the cut-out points would fail to open when the generator stops charging, the battery would discharge through the generator at a very high rate, running the battery down. A circuit breaker (par. 73) in the generator circuit protects the generator from continued abnormal loads. A short circuit in the system will cause the circuit breaker to open. If the circuit breaker is faulty and fails to protect the circuit in which it is located, it should be replaced. A short circuit will cause the destruction of the wires and some of the devices in the circuit.

#### d. Trouble Shooting.

##### (1) BATTERY FULLY CHARGED BUT USES EXCESSIVE WATER.

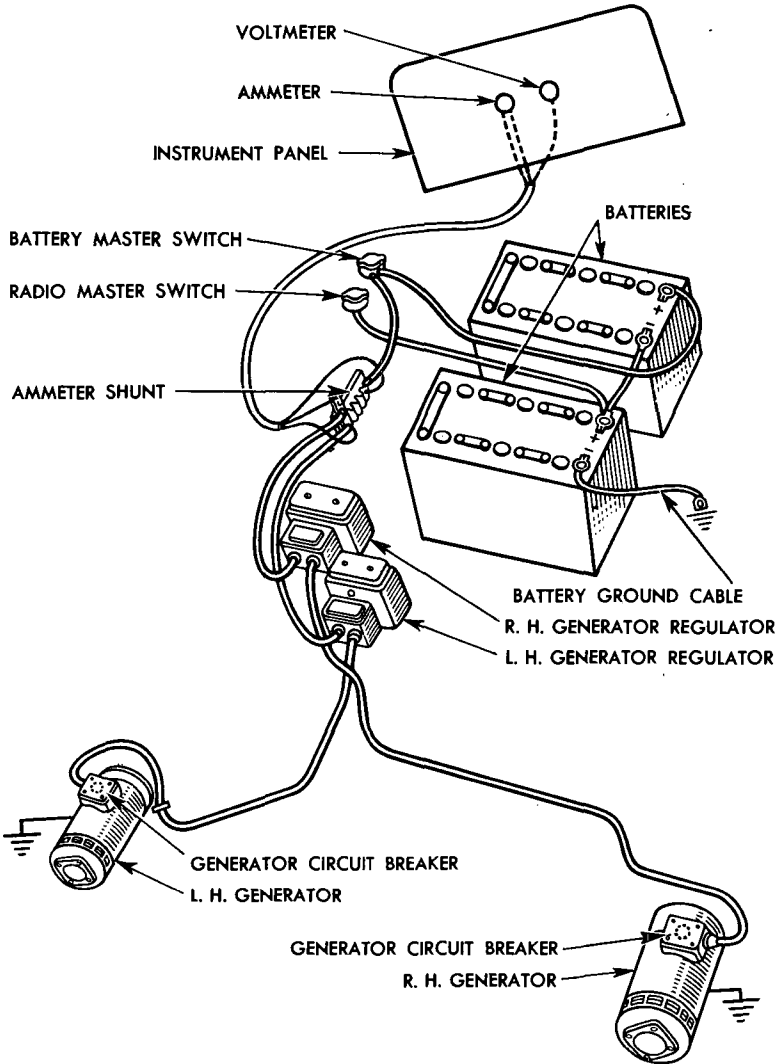
Possible Cause	Possible Remedy
Generator regulator faulty.	Replace (par. 74 c).

##### (2) BATTERY FAILS TO CHARGE OR CHARGES INSUFFICIENTLY.

Generator ground circuit resistance.	Correct, removing abnormal resistance (subpar. b above).
Generator armature brush to battery circuit resistance.	Correct, removing abnormal resistance (subpar. c above).
Generator regulator faulty.	Replace (par. 74 c).
Generator faulty.	Replace (par. 72 c).



3-INCH GUN MOTOR CARRIAGE M10A1



RA PD 27551

Figure 50—Generating System

**ELECTRICAL SYSTEM AND EQUIPMENT**

**(3) BATTERY CHARGES FULLY BUT RUNS DOWN QUICKLY.**

<b>Possible Cause</b>	<b>Possible Remedy</b>
Battery is worn out or defective.	Replace (par. 76 d).
Short circuit in system (subpar. c (2) above).	Locate and correct (par. 109 b (2)).
Cut-out points fail to open.	Replace generator regulator (par. 74 c).

**(4) GENERATOR BURNS OUT.**

Faulty generator regulator.	Replace generator (par. 72 c) and generator regulator (par. 74 c).
Armature and field wires transposed at either the generator or the regulator.	Replace the generator (par. 72 c) and the generator regulator (par. 74 c) and connect wires correctly (fig. 49).

**(5) GENERATOR FAILS TO GENERATE OR GENERATES INSUFFICIENTLY.**

Generator burned out.	Replace generator (par. 72 c) and generator regulator (par. 74 c) making sure armature and field wires are not transposed.
Generator commutator dirty (par. 72 b (2)).	Clean commutator with sand paper.
Generator commutator worn (par. 72 b (2)).	Replace generator (par. 72 c).
Generator brushes worn (par. 72 b (2)).	Replace brushes.
Generator brushes sticking (par. 72 b (2)).	Free brushes.
Excessive resistance in generator ground circuit (subpar. b above).	Clean and tighten all contacts as outlined in subparagraph b above.
Excessive resistance in generator armature brush to battery circuit (subpar. c above).	Remove excessive resistance (see subpar. c above for points of possible resistance).
Resistance in cut-out points (subpar. c above).	Replace generator regulator (par. 74 c).
Voltage regulator incorrect (par. 74 a (1)).	Replace generator regulator (par. 74 c).
Current limitation incorrect (par. 74 a (2)).	Replace generator regulator (par. 74 c).
Cut-out closing voltage too high.	Replace generator regulator (par. 74 c).

### 3-INCH GUN MOTOR CARRIAGE M10A1

Probable Cause	Probable Remedy
Cut-out points fail to close due to the generator regulator not being grounded.	Establish a good ground from the regulator housing to the hull to complete cut-out shunt coil circuit.
Cut-out points fail to close due to defective shunt coil.	Replace generator regulator (par. 74 c).
(6) AMMETER READS ABOVE NORMAL	(par. 5 a (1) (d)).
Ammeter defective.	Replace ammeter (par. 84 a).
Generator regulator faulty.	Replace generator regulator (par. 74 c).
(7) VOLTMETER READS ABOVE NORMAL	(par. 5 a (1) (f)).
Voltmeter defective.	Replace voltmeter (par. 86).
Generator regulator not limiting the voltage.	Replace the generator regulator (par. 74 c).

## 72. GENERATORS.

**a. Description.** Two special Ford tank generators model GAA are used. The rating of each generator is 30 volts 50 amperes. The capacity of each is 1,500 watts. Current control is obtained by generator regulators (par. 74) mounted on the floor of the fighting compartment (fig. 51). The generators are mounted on the accessory drive housing on each side of the engine compartment and driven by the accessory drive shafts (fig. 22).

### b. Generator Maintenance.

(1) **LUBRICATION.** Generators are properly lubricated at overhaul periods and should not require additional lubricant between overhaul periods.

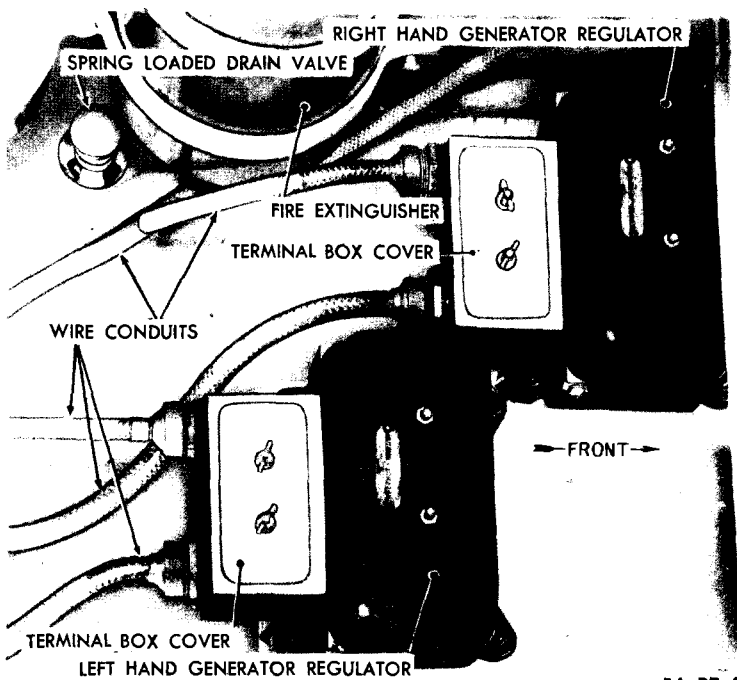
(2) **INSPECTION.** Remove generator cover band and inspect commutator and brushes at regular intervals. Check the brushes for sticking and wear; check commutator for wear. If the commutator is out of round, badly worn, or scored, replace the generator. In an emergency, if the commutator is dirty it may be cleaned with PAPER, flint, class B, No. 00. *Never use emery cloth to clean a commutator.*

**c. Generator Replacement.** Open engine compartment doors. Turn off battery master switch. Disconnect wires from armature and field terminals. Disconnect flexible conduit. Remove the four nuts which hold the generator to accessory drive housing and remove the generator. To install the generator, make certain that there is no paint on generator or accessory drive housing flange. Reverse the sequence of the steps in the removal procedure.

## 73. GENERATOR CIRCUIT BREAKER.

**a. Description.** The generator circuit breaker located in the generator terminal box on the top of each generator is thermostatically

**ELECTRICAL SYSTEM AND EQUIPMENT**



RA PD 27723

**Figure 51—Generator Regulators**

controlled. This circuit breaker protects the generator and wires from burning in case of an overload in the circuit. No push button is required to restore the circuit breaker operation, as it opens and closes thermostatically. This circuit breaker does not prevent the battery from running down if the cut-out points stick. It merely prevents the generator from burning out.

**b. Replacement.** Remove the four screws which hold the generator terminal box cover (fig. 22). Lift off the cover, and disconnect the two wires from the circuit breaker. Remove the two bolts which hold the circuit breaker to the terminal box cover and remove the circuit breaker. To install the circuit breaker, reverse the sequence of the steps in the removal procedure.

**74. GENERATOR REGULATOR.**

**a. Description.** The two generators are each equipped with a generator regulator located on the floor of the fighting compartment. The generator regulator includes a voltage regulator, current limiter, and reverse current relay or cut-out.

(1) **THE VOLTAGE REGULATOR UNIT.** This unit controls the voltage of the generator, and holds the potential constant between the limits of 27½ and 29½ volts (at 70 F surrounding temperature) de-

### **3-INCH GUN MOTOR CARRIAGE M10A1**

pending on the state of charge of the battery. The current output is automatically varied in accordance with the state of charge of the battery and the current strength in the battery circuit.

(2) **THE CURRENT LIMITATOR.** The current limiter unit limits the maximum current output of each generator from 50 to 54 amperes to prevent an overload in the generator.

(3) **THE REVERSE CURRENT RELAY OR CUT-OUT.** This unit automatically connects the generator to the battery when the generator voltage is above the battery voltage and again disconnects the generator when its voltage falls below the battery voltage. The cut-out points close at between 25 and 26.5 volts.

**b. Inspection and Adjustments.** When properly installed and operating, the generator regulators will not require any adjustment. If the regulator fails to control the voltage (subpar. a (1) above) or to limit the current (subpar. 74 a (2) above), and it has been determined that trouble is not caused by loose or transposed connections or faulty generator, the generator regulator at fault should be replaced.

**c. Generator Regulator Replacement.** Turn the battery master switch off. Remove the wing nuts from the cover over the regulator terminal box (fig. 51) and remove cover. Disconnect wires and conduits. Remove the four nuts which hold the regulator in place and remove regulator. To install the generator regulator, reverse the sequence of the steps in the removal procedure, making sure that the regulator is properly grounded to the hull.

### **75. GENERATOR FILTER.**

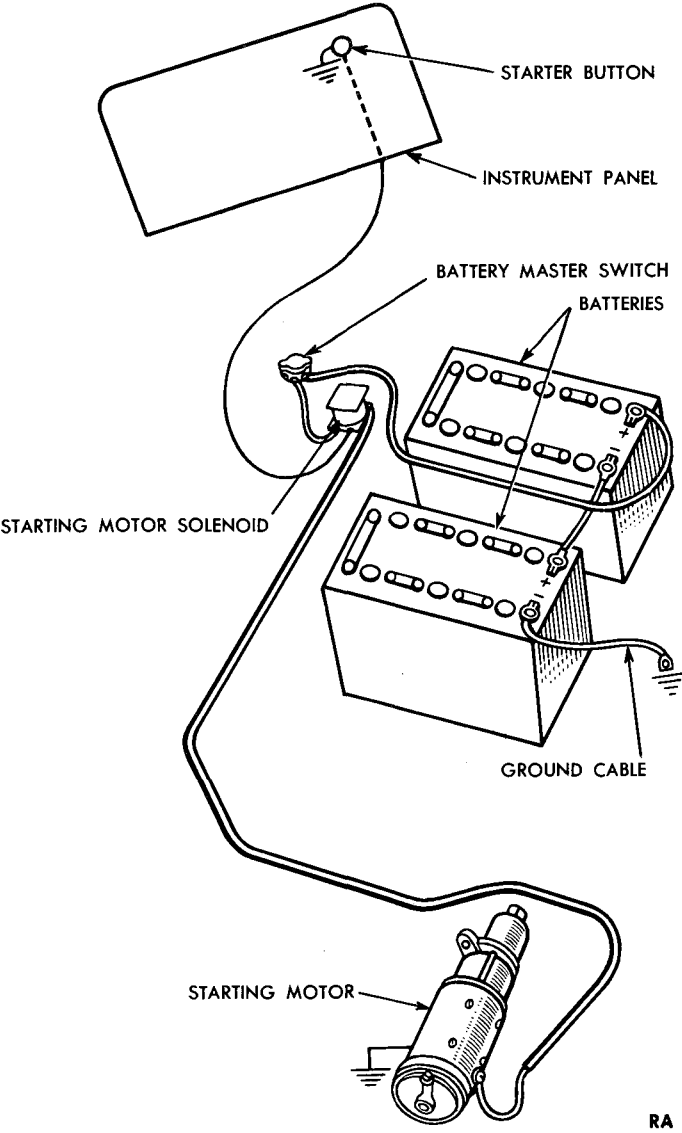
**a. Description.** A generator filter is provided in each generator regulator which prevents the radio from picking up generator noise.

**b. Replacement.** Turn the battery master switch off. Remove the four nuts which hold the regulator to the floor of the vehicle (fig. 51). Turn regulator upside down and remove the lock wire and screws from the bottom cover. Remove the lock wire and screw from each terminal of the filter. Remove the lock wire and two screws from one end of the filter strap and one screw from the other end. Remove the filter. To reinstall the filter, reverse the sequence of the steps in the removal procedure.

### **76. BATTERY.**

**a. Description.** Two 12-volt storage batteries connected in series are located on the left side of the hull floor in the fighting compartment behind the driver. A battery master switch (par. 100) and a radio master switch (par. 101) are provided. When these switches are both off, the batteries are disconnected and all electrical circuits are open.

ELECTRICAL SYSTEM AND EQUIPMENT



RA PD 27554

Figure 52—Starting System

### **3-INCH GUN MOTOR CARRIAGE M10A1**

**b. Maintenance and Inspections.** Battery terminals and terminal posts will be frequently checked, cleaned, and coated with petroleum. Check the battery fluid level once a week and after every long run. Maintain the level to one-fourth inch above the top of the plates by adding water. (Water suitable for drinking will be satisfactory for the batteries.) Take a specific gravity reading every 25 hours and exchange a battery having a specific gravity of 1.225 or less at 80 F for a fully charged one.

**c. Specific Gravity Tests.** The state of charge of the batteries can be determined by a specific gravity reading of the electrolyte. Use a hydrometer equipped with a thermometer and a temperature compensating table, and adjust the reading to compensate for the temperature of the electrolyte. A specific gravity of 1.275 or more indicates full charge. A specific gravity reading of 1.225 or less indicates approximately one-half full charge. Batteries nearly discharged will freeze at freezing temperature.

**d. Battery Replacement.** Turn the battery master switch off. Open door in the turret platform and remove the cover from the battery. Disconnect the battery cables. Remove the nuts which hold the battery holding straps to battery box. Remove the battery. To install the battery, reverse the sequence of the steps in the removal procedure, placing batteries so that the ends with the terminal posts will be next to the propeller shaft.

**e. Battery Cables.**

(1) **DESCRIPTION.** These are heavy cables made up of many strands of small wire and are heavily insulated. As these cables carry heavy current, the terminals must be kept clean and the cables must be inspected periodically for abrasions of the insulation. Terminal connections are to be cleaned as outlined in subparagraph b.

(2) **BATTERY CABLE REPLACEMENT.** Disconnect cable connections at both ends of the cable and remove the cables. To reinstall, reverse this procedure, making sure that a good clean contact is made.

## **77. STARTING SYSTEM.**

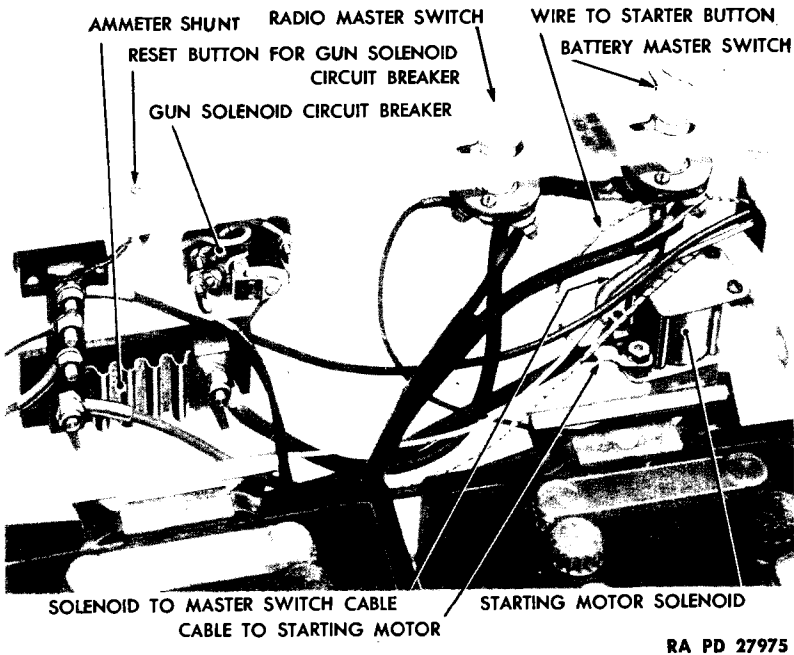
**a. Description.** As shown in figure 52, the starting system consists of the starter (par. 78), starter solenoid (par. 79), the starter button on the instrument panel (par. 88), the batteries (par. 76), and the various wires and cables connecting these units.

**b. Trouble Shooting.** Trouble shooting for the starting system is covered in paragraph 36.

## **78. STARTER.**

**a. Description.** The starter (fig. 17) is a 24-volt type mounted on the right side of flywheel housing and its power is transmitted to

**ELECTRICAL SYSTEM AND EQUIPMENT**



RA PD 27975

**Figure 53—Electrical Devices in Battery Compartment**

the engine through an automatic drive. A solenoid switch, located in the battery compartment, closes the electrical circuit of the starter when the starter button on the instrument board is pressed. Rotation of the starting motor shaft causes the pinion of the automatic drive to advance and mesh with the flywheel ring gear. After the engine starts and the flywheel speed exceeds that of the starter, the pinion releases from the flywheel automatically. The starter bearings do not require lubricating between overhaul periods.

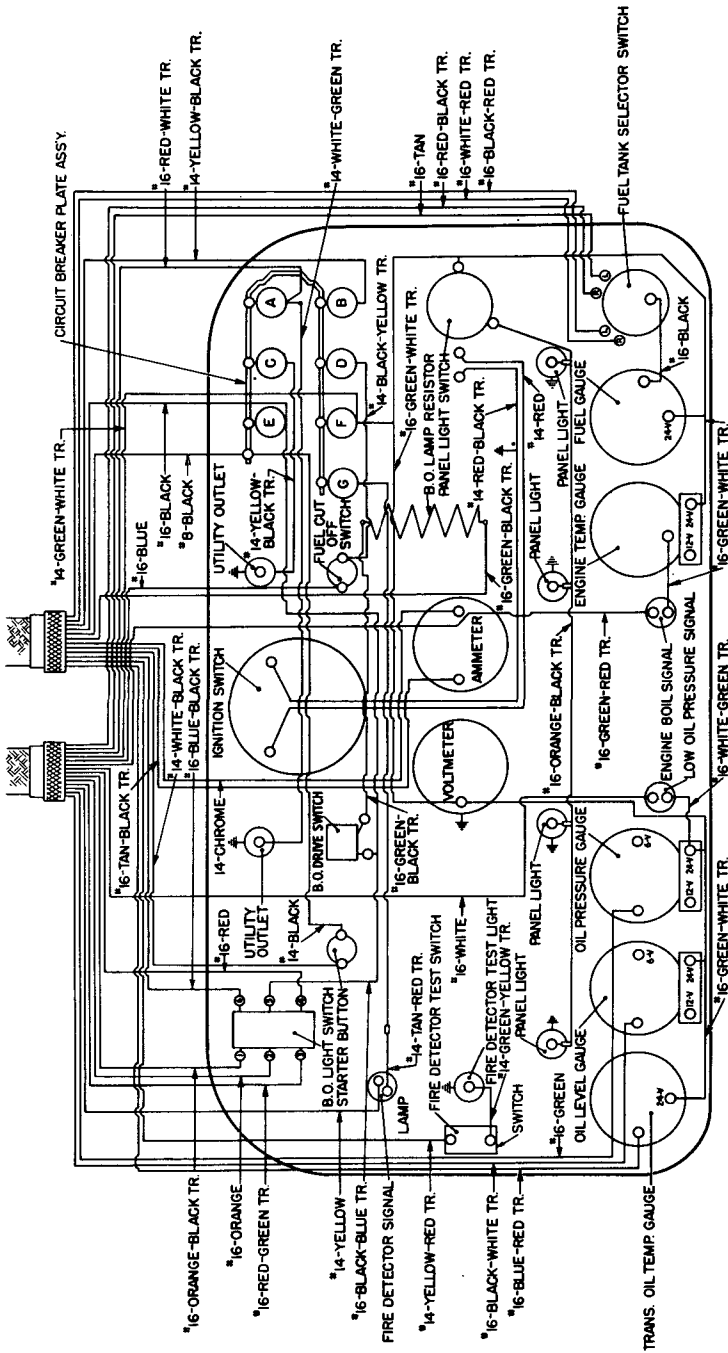
**b. Starter Replacement.** Open the engine compartment doors. Remove the engine compartment floor plate (par. 37 a (4)). Disconnect starter cable. Remove the two nuts and one bolt which hold the starter to the engine oil pan. Remove the starter. To install the starter, reverse this procedure.

**79. STARTER SOLENOID.**

**a. Description.** The entire circuit from the batteries to the starter requires heavy cables, due to the large amount of current used. In order to avoid the running of heavy cables up to the instrument panel, a solenoid switch is installed in the starter circuit. This solenoid switch closes magnetically when the starter button on the instrument



3-INCH GUN MOTOR CARRIAGE M10A1



RA PD 27690

Figure 54—Instrument Panel Wiring Diagram

## ELECTRICAL SYSTEM AND EQUIPMENT

panel is pressed. The starter solenoid switch is mounted in the battery compartment directly below the battery master switch (fig. 53).

### b. Replacement.

(1) **REMOVAL** (fig. 53). Turn the battery master switch off. Raise the battery cover in the turret platform. Remove the battery compartment cover and remove the partition separating the battery and switch compartment. Remove the positive cable connection from the battery terminal. Disconnect the cable running to the starter at the solenoid terminal. Disconnect the short length of cable running from the solenoid to the master switch at the switch terminal. Remove the two screws holding the solenoid switch to the bracket in battery compartment. Remove solenoid by moving it over to the center of the battery case and lifting out. Disconnect the small (solenoid to starter button) wire from solenoid switch.

c. **Installation.** Reverse the sequence of the steps in the removal procedure.

## 80. INSTRUMENT PANEL.

a. **Description.** Figures 6 and 55 show the location of the various electrical and nonelectrical instruments, meters, and switches on the instrument panel. A description and the use of the various instruments and devices is given in paragraph 5.

b. **Removal of Instrument Panel to Gain Access to Instruments.** Turn the battery master switch off. Remove the speedometer trip reset from the clip at the bottom of the panel by loosening the knurled nut with pliers. Disconnect the tachometer drive from the tachometer head. Disconnect the speedometer drive from the speedometer head. Remove the six screws which hold the panel to the case and pull the top of the panel backward. The panel may now be laid face down on the sponson to remove any of the wires, instruments, or devices as may be required.

c. **Installation.** Reverse the sequence of the steps in the removal procedure.

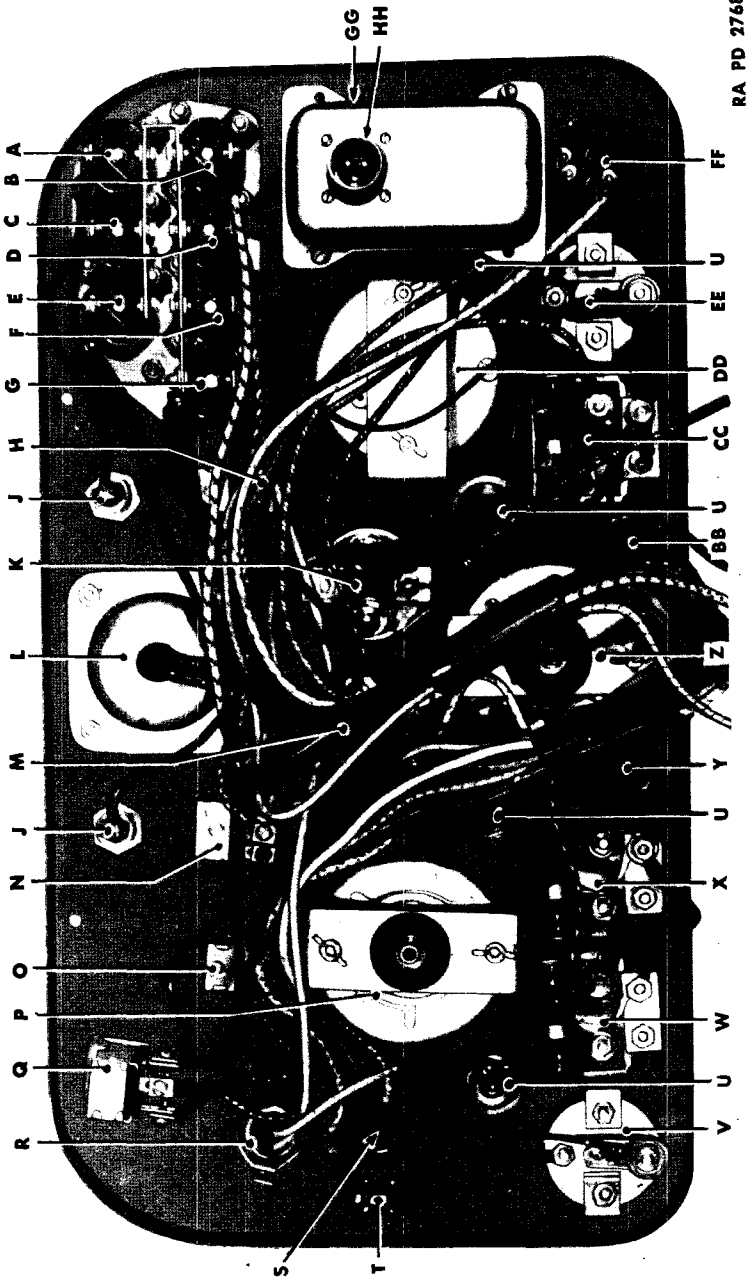
## 81. CIRCUIT BREAKERS.

a. **Description** (fig. 55). The use and operation of the seven circuit breakers on the instrument panel is covered in paragraph 5 a (2). The generator circuit breaker is covered in paragraph 73.

### b. Replacement.

(1) **REMOVAL.** Remove the instrument panel (par. 80 b). Remove the two nuts holding the circuit breaker assembly plate to the instrument panel and remove the assembly. Remove the wires from all seven terminals of the breaker assembly. Remove the copper connecting bar which connects the circuit breakers together. Each individual

3-INCH GUN MOTOR CARRIAGE M10A1



RA PD 27685

Figure 55—Instrument Panel—Back

ELECTRICAL SYSTEM AND EQUIPMENT

- |  |   |  |
|--|---|--|
| <b>A</b> —CIRCUIT BREAKER FOR RIGHT HAND UTILITY OUTLET CIRCUIT  | <b>J</b> —UTILITY OUTLET                    | <b>W</b> —OIL LEVEL GAGE   |
| <b>B</b> —CIRCUIT BREAKER FOR SIREN CIRCUIT  | <b>K</b> —AMMETER                           | <b>X</b> —OIL PRESSURE GAGE  |
| <b>C</b> —CIRCUIT BREAKER FOR LEFT HAND UTILITY OUTLET CIRCUIT   | <b>L</b> —IGNITION SWITCH                   | <b>Y</b> —LOW OIL PRESSURE SIGNAL  |
| <b>D</b> —CIRCUIT BREAKER FOR FUEL CUT-OFF AND HULL LAMP CIRCUITS  | <b>M</b> —VOLTMETER                         | <b>Z</b> —SPEEDOMETER  |
| <b>E</b> —CIRCUIT BREAKER FOR BLACK-OUT DRIVE SWITCH CIRCUIT   | <b>N</b> —BLACKOUT DRIVING LIGHT SWITCH     | <b>AA</b> —TRIP MILEAGE RESET  |
| <b>F</b> —CIRCUIT BREAKER FOR CIRCUIT FOR PANEL LIGHTS, FUEL GAGE, WATER TEMPERATURE, LOW OIL PRESSURE LIGHT, WATER BOIL SIGNAL LIGHT, OIL LEVEL GAGE, VOLTMETER AND TRANSMISSION OIL TEMPERATURE GAGE | <b>O</b> —STARTER BUTTON                    | <b>BB</b> —ENGINE BOIL SIGNAL  |
| <b>G</b> —CIRCUIT BREAKER FOR FIRE DETECTOR SIGNAL CIRCUIT   | <b>P</b> —TACHOMETER                        | <b>CC</b> —ENGINE TEMPERATURE GAGE   |
| <b>H</b> —FUEL CUT-OFF SWITCH BUTTON   | <b>Q</b> —LIGHT SWITCH                      | <b>DD</b> —CLOCK   |
|  | <b>R</b> —FIRE DETECTOR SIGNAL              | <b>EE</b> —FUEL LEVEL GAGE   |
|  | <b>S</b> —FIRE DETECTOR TEST LIGHT          | <b>FF</b> —SELECTOR SWITCH   |
|  | <b>T</b> —FIRE DETECTOR TEST SWITCH         | <b>GG</b> —PANEL LIGHT RHEOSTAT SWITCH (UNDERNEATH IGNITION WIRE CONNECTION HOUSING) |
|  | <b>U</b> —INSTRUMENT PANEL LIGHTS           | <b>HH</b> —IGNITION WIRE CONNECTION  |
|  | <b>V</b> —TRANSMISSION OIL TEMPERATURE GAGE |  |

RA PD 27685B

Legend for Figure 55—Instrument Panel—Back

### **3-INCH GUN MOTOR CARRIAGE M10A1**

circuit breaker is secured to the breaker plate with two screws. Remove the circuit breaker assembly or the individual unit at fault as may be required.

(2) **INSTALLATION.** When reinstalling the circuit breakers, refer to figure 54 for wire size and color. Reverse the sequence of the steps in the removal procedure.

#### **82. FUEL CUT-OFF SWITCH.**

a. **Description** (fig. 55). The use of the fuel cut-off switch is described in paragraphs 5 a (1) (b) and 53.

b. **Replacement.** Remove the instrument panel (par. 80 b). Disconnect the two wires at the switch. Loosen the nut at the rear side of the panel. Remove the nut on the front side of the panel. Remove the switch. When reinstalling the switch, refer to figure 54 for wire size and color. Reverse the steps of the removal procedure.

#### **83. UTILITY OUTLET SOCKETS.**

a. **Description** (fig. 55). The outlet sockets are provided in the instrument panel and one in the junction box in the engine compartment to the left of the rear door. These sockets provide an electrical outlet for the inspection lamp. No switches are provided for these sockets as they are in series with the battery master switch which must be turned on before current is available at the sockets.

b. **Instrument Panel Utility Socket Replacement.** Turn the battery master switch off. Remove the instrument panel (par. 80 b). Disconnect the wire from the socket. Remove the lock nut from the socket and remove the socket. To install the socket, reverse the sequence of the steps in the removal procedure.

c. **Junction Box Utility Socket Replacement.** Open the rear door of the engine compartment (par. 37 a (3)). Turn the battery master switch off. Remove the cover from the junction box. Disconnect the wire from the socket. Remove the lock nut from the socket and remove the socket. To install, reverse the sequence of the steps in the removal procedure.

#### **84. AMMETER.**

a. The use of the ammeter is explained in paragraph 5 a (1) (d). To remove the ammeter, remove the instrument panel (par. 80 b). Remove the two nuts which hold the ammeter to the panel, and disconnect the two wires. Remove the instrument from the front side of the panel (fig. 6). When installing the ammeter, refer to figure 54 for wire size and color, and reverse the steps of the removal procedure.

#### **85. IGNITION SWITCH.**

a. The operation of the ignition switch is described in paragraph 5

## ELECTRICAL SYSTEM AND EQUIPMENT

a (1) (e). The replacement of the ignition switch is described in paragraph 48 a.

### 86. VOLTMETER.

a. The use of the voltmeter is explained in paragraph 5 a (1) (f). To remove the voltmeter, remove the instrument panel (par. 80 b). Disconnect the two wires from the voltmeter; *do not remove the round resistor*. Remove the two nuts which hold the voltmeter to the panel and remove the voltmeter (fig. 55). When reinstalling the voltmeter, refer to figure 54 for wire size and color, and reverse the steps of the removal procedure.

### 87. BLACKOUT DRIVING LIGHT SWITCH.

a. The operation of the blackout switch is described in paragraph 5 a (1) (g). To remove the blackout driving light switch, remove the instrument panel (par. 80 b). Pull the button all the way out, loosen the small lock screw, and unscrew the button. Disconnect the two wires from the switch (fig. 55). Remove the nut which holds the switch to the instrument panel and remove the switch. When reinstalling the blackout driving light switch, refer to figure 54 for wire size and color, and reverse the steps of the removal procedure.

### 88. STARTER BUTTON.

a. The operation of the starter button is described in paragraph 5 a (1) (h). To remove the button, remove the instrument panel (par. 80 b). Disconnect the two wires running to the switch (fig. 55). Loosen the nut from the rear of the instrument panel. Remove the nut from the front of the instrument panel and remove the switch. Reinstall the starter button switch by reversing the above procedure (see fig. 54 for wire colors).

### 89. LIGHT SWITCH.

a. The operation of the light switch is described in paragraph 5 a (1) (j). To remove the light switch, remove the instrument panel (par. 80 b). Disconnect the seven wires from the switch, noting wire colors as removed. Pull the button all the way out by pressing the spring button on the side of the switch. Remove the light switch button by loosening the small lock screw and unscrewing the button. Remove the nut on the top of the switch and pull the housing back. Remove the nut which holds the switch to the instrument panel, and remove the switch. Reinstall the light switch by reversing the above procedure (see fig. 54 for wire colors and size).

### 90. FIRE DETECTOR SIGNAL.

a. The operation of the fire detector signal is described in paragraph 5 a (1) (k). The lamps can be replaced by removing the lens from the front of the panel with a small screwdriver and replacing the

**3-INCH GUN MOTOR CARRIAGE M10A1**

lamps. To remove the signal light switch, remove the instrument panel (par. 80 b). Remove the two wires from the switch (fig. 55). Remove the nut from the front of the instrument panel. Remove the switch. Reinstall the switch by reversing the above procedure.

**91. INSTRUMENT PANEL LIGHTS.**

a. The instrument panel is illuminated by four lamps located in back of the instrument panel, each directly behind a removable plug on the face of the panel (fig. 55). To replace the lamp, remove the plug from the front of the instrument panel with a small screwdriver, press in on the lamp, at the same time turning it until released when it may be pulled out. Insert a new lamp.

**92. TRANSMISSION OIL TEMPERATURE GAGE.**

a. **Description** (fig. 55). The transmission oil temperature gage consists of the instrument on the panel and the transmission unit located on the left side of the transmission in the driver's compartment. The use of the transmission oil temperature gage is covered in paragraph 5 a (1) (o).

b. **The Panel Unit Replacement.** Remove the instrument panel (par. 80 b). Disconnect the two wires from the gage. Remove the two nuts which hold the instrument to the panel (do not remove the round resistor) and remove the instrument from the front of the panel. Reinstall the gage by reversing the steps of the removal procedure (see fig. 54 for wire colors).

c. **The Oil Temperature Gage Transmission Unit** (fig. 7). The oil temperature gage transmission unit is located on the left side of the transmission in the driver's compartment (fig. 7). To remove the transmission unit, turn off battery master switch and remove conduit shield cap. Disconnect the wire running to the unit. Remove the unit from the transmission case. Reinstall the unit by reversing the steps of the removal procedure.

**93. OIL LEVEL GAGE.**

a. **Description** (fig. 55). The electrically operated engine oil level gage consists of the gage in the instrument panel and the engine unit located on the left side of the engine oil pan in the center near the bottom. The operation of the gage is outlined in paragraph 5 a (1) (p).

b. **The Panel Unit Replacement.** To remove the panel unit, remove the instrument panel (par. 80 b). Remove the two wires from the back of the instrument. Remove the two units which hold the gage to the panel, remove the resistor, and remove the gage. Reinstall the gage by reversing the steps of the removal procedure. Refer to figure 54 for wire colors and size. Install the resistor so that it faces the top of the instrument panel.

## ELECTRICAL SYSTEM AND EQUIPMENT

c. **The Engine Unit Replacement.** To remove the engine unit located on left side of the oil pan (fig. 18), drain the engine oil (par. 37 a (6)). Remove the engine compartment floor plate (par. 37 a (4)). Turn the battery master switch off. Remove shield cap and disconnect the wire from the terminal in the center of the unit. Remove lock wire and the six screws and pull the unit from the oil pan. Reinstall the unit by reversing the steps of the removal procedure, using a new gasket.

### 94. LOW OIL PRESSURE SIGNAL.

a. **Description** (fig. 55). The signal consists of plastic-lensed light in the instrument panel, and the engine unit. The engine unit is the smaller of the two units, located on a bracket on the hull at the rear in the engine compartment to the right of the compartment rear door. The operation of the signal light is outlined in paragraph 5 a (1) (r).

b. **The Panel Signal Light Lamp Replacement.** To remove the signal light lamp, turn the battery master switch off. Pry the signal plug from the panel with a small screwdriver. Remove the lamp (while the lamp is out, the wire terminals can be pulled out for inspection). Install lamp and reinstall the signal plug.

c. **The Oil Pressure Signal Engine Unit Replacement.** Open the engine compartment rear door. Turn the battery master switch off. Remove shield cap and disconnect the wire from the unit. Remove the unit by unscrewing. Reinstall by reversing the steps in the removal procedure.

### 95. ENGINE BOIL SIGNAL.

a. **Description** (fig. 55). The use of the engine boil signal is covered in paragraph 5 a (1) (t). The signal light consists of a plastic-lensed light in the panel and the engine compartment unit located on the right-hand side of the radiator inlet casting (fig. 46).

b. **Signal Light Lamp Replacement.** To remove the signal light lamp, turn the battery master switch off and pry the signal lens plug from the panel with a small screwdriver. Remove the lamp (while the lamp is out, the wire terminal can be pulled out for inspection). Install the lamp signal plug.

c. **The Engine Boil Signal Engine Compartment Unit Replacement** (fig. 46). To remove the engine unit, turn the battery master switch off. Drain approximately 2 gallons from the cooling system, remove the shield cap, and disconnect the wire running to the center of the unit. Remove the unit from the casting. Reinstall the unit by reversing the removal procedure.



**3-INCH GUN MOTOR CARRIAGE M10A1**

**96. ENGINE TEMPERATURE GAGE.**

a. **Description.** The engine temperature gage consists of the instrument in the panel, and the engine compartment unit located in the radiator inlet casting on the left side (fig. 46). The use of the engine temperature gage is covered in paragraph 5 a (1) (u).

b. **Panel Unit Replacement** (fig. 55). To remove the gage, remove the instrument panel (par. 80 b). Remove the two nuts which hold the gage to the panel, remove the resistor, and remove the gage from the panel. Disconnect the three wires running to the gage. When reinstalling the gage, refer to figure 54 for wire size and color, and reverse the steps in the removal procedure. Install the resistor so that it faces the top of the panel.

c. **Temperature Gage Engine Compartment Unit Replacement.** Open the engine compartment doors. Drain approximately 2 gallons from the cooling system. Remove the conduit shield cap from connection. Disconnect wire running to the unit. Remove the unit from the casting. Reinstall the unit by reversing the steps in the removal procedure.

**97. FUEL LEVEL GAGE.**

a. **Description.** The fuel level gage consists of the instrument on the panel and the tank units. The operation of the fuel level gage is explained in paragraph 5 a (1) (w).

b. **Panel Unit Replacement** (fig. 55). To remove the fuel level gage panel unit, remove the instrument panel (par. 80 b). Disconnect the wires running to the gage. Do not remove resistor. Note color of wires. Remove the two nuts which hold the gage to the instrument panel, and remove the gage from the front of the panel. Reinstall the gage by reversing the above procedure (see fig. 54 for color and size of wires).

c. **Fuel Level Gage Tank Unit.** A fuel gage tank unit is installed in each of the four fuel tanks. To remove tank unit, turn the battery master switch off. Remove the fuel tank (par. 60 c, d, and e). Disconnect the gage wire, and remove the screws holding the unit to the tank. Reinstall by reversing the steps in the removal procedure.

**98. FUEL LEVEL GAGE SELECTOR SWITCH.**

a. The operation of the fuel level gage selector switch is covered in paragraph 5 a (1) (w). To remove the switch (fig. 55), remove the instrument panel (par. 80 b). Loosen the small lock screw in the selector switch control knob and remove the knob from the shaft. Remove the nut from the front of the switch and remove the switch from the rear of the panel. Disconnect the five wires running to the switch and remove the switch. Reinstall the switch by reversing the sequence of steps in the removal procedure (see fig. 54 for color and sizes of wires).

## ELECTRICAL SYSTEM AND EQUIPMENT

### 99. PANEL LIGHT RHEOSTAT SWITCH.

a. A description of the rheostat switch is given in paragraph 5 a (x). To remove the rheostat (fig. 55), remove the instrument panel as outlined in paragraph 80 b. Loosen the small lock screw in the control knob and remove the knob from the shaft. Remove the nut from the front of the switch, and remove the switch from the rear side of the panel. Disconnect the wires from the rheostat. When reinstalling the rheostat, refer to figure 54 for wire size and color, and reverse the steps in the removal procedure.

### 100. BATTERY MASTER SWITCH.

a. The use of the battery master switch is described in paragraph 5 b (10). To remove the battery master switch (fig. 53), disconnect negative terminal at the battery. Remove the partition separating battery and switch compartment. Remove the screw from the top of the handle, and remove the handle. Remove the terminal nuts and leads from switch. Remove the two retaining bolts from the side of the case. Remove the switch. Reverse the steps in the removal procedure to install the battery master switch.

### 101. RADIO MASTER SWITCH.

a. The use of the radio master switch is described in paragraph 5 b (11). The radio master switch (fig. 53) is removed and installed by the same procedure as outlined for the battery master switch (par. 100).

### 102. HEADLIGHTS.

a. **General.** The front slope of the vehicle mounts two service headlights with blackout marker light combinations, controlled by the light switch on the instrument panel, or a *blackout headlight* with a blackout marker light combination controlled by the blackout light switch on the instrument panel. A description of the operation of the switches controlling the blackout headlights and the service headlights is given in paragraph 5 a (j). When changing from one type to the other, pull out the headlight lock and turn one-quarter turn (fig. 56). Headlight can then be lifted out. When neither the service headlights nor the blackout headlights are used, be sure the plug provided is inserted in the socket to protect the terminals (fig. 57).

#### b. Service Headlights.

(1) **DESCRIPTION.** With the service head lamps in place, either the service head lamps or the blackout marker lights may be used. However, even with the blackout marker lights in operation, the service head lamp reflectors can pick up and reflect other light and, under certain conditions, the service head lamps should be removed and blackout head lamps or the plugs should be installed in the sockets.

(2) **SERVICE HEADLIGHT LAMP.** The service headlights use a sealed

3-INCH GUN MOTOR CARRIAGE M10A1

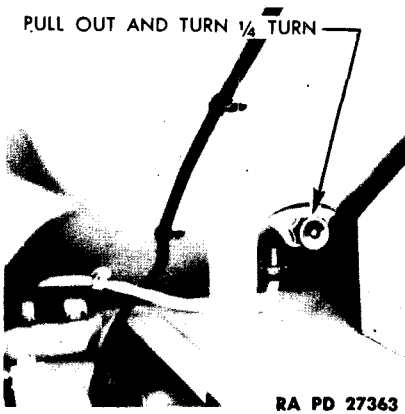


Figure 56—Head Lamp Lock



Figure 57—Head Lamp Socket Plug in Place

beam, 24-volt, single filament lamp. To remove the bulb, turn off battery master switch. Remove the screw attaching the frame to the headlight body and remove the frame. Disconnect the wires from the terminals on back of the lamp. With a screwdriver unhook the six wire clips and remove the retainer. Remove the lamp. To install a new lamp, reverse the above procedure.

c. **Blackout Headlight.**

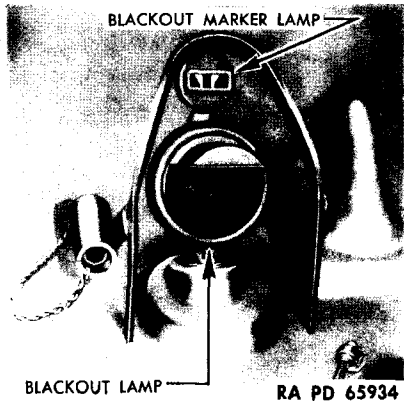
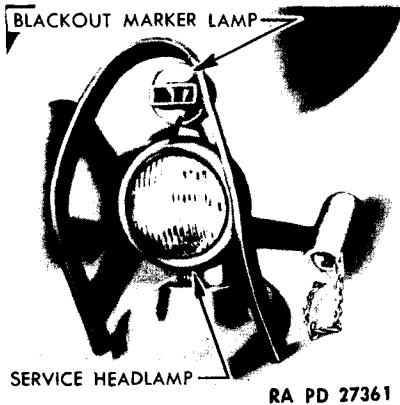
(1) **DESCRIPTION.** The blackout headlight is used on the left side only. It throws a thin, flat beam of light that cannot be readily seen from above, yet provides enough illumination to miss most obstacles. The lamp is of the sealed beam type with only a narrow strip of the lens exposed and a hood at the top. The lamp is 6-volt, 10-candlepower. A resistor (fig. 62) is included in series in the circuit that permits it to be used in a 24-volt system. To replace the blackout headlight lamp, follow the same procedure as used to replace the service headlight lamp (par. 102 b (2)).

(2) **BLACKOUT MARKER LAMPS.** The blackout marker lights, mounted on top of both the service headlights and the blackout headlights, use a single contact 24-volt bayonet base 3-candlepower lamp. To replace the lamp, turn battery master switch off. Remove the screw attaching the lens frame to the body of the light and remove the frame. Press the lamp in and turn it slightly counterclockwise and remove the lamp from the socket. Replace the lamp by reversing the above procedure.

103. **TAILLIGHTS.**

a. A taillight is mounted on the rear of the vehicle on each side. The lamps in the two taillights are operated by the light switch on the

**ELECTRICAL SYSTEM AND EQUIPMENT**



**Figure 58—Service Headlight      Figure 59—Blackout Headlight**

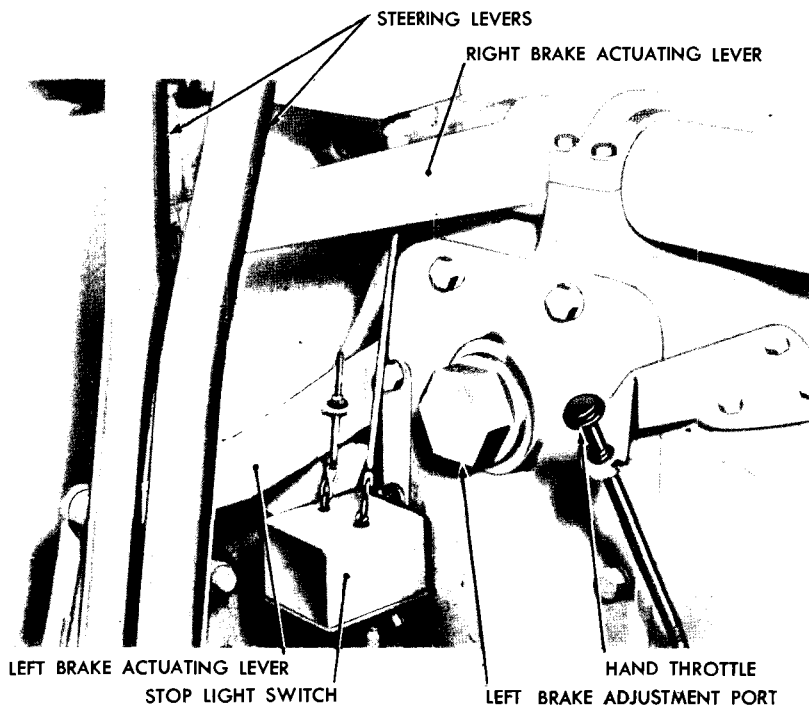
instrument panel. Each taillight consists of two sealed units. The two sealed units for each light are held in place by a frame attached to the metal housing or body of the light with two screws. The left taillight assembly has three filaments, for service, blackout taillight, and service stop light, respectively. The right taillight has two filaments for blackout stop light and blackout taillight, respectively. To replace the sealed taillight lamp, turn battery master switch off. Remove the two screws attaching lens frame to the body of the taillight. Remove the frame. Pull the defective sealed lamp straight out to remove it. To install a new lamp, reverse the above procedure.

**104. STOP LIGHT SWITCH.**

**a. Description (fig. 60).** The stop light switch is located in the driver's compartment in front of the steering levers. This switch completes the electrical circuit for the operation of the service and blackout stop lights. The switch is connected to each steering lever through adjustable linkage. Both steering levers must be pulled back before the circuit is completed and the stop light functions.

**b. Replacement.** Unscrew the nut from each link rod on each steering lever. Remove the two cap screws which hold the switch bracket to the transmission plate. Tip the switch box up, and remove the cover by removing two cap screws. Unscrew the knurled nut from the conduit at the bottom of the switch. Disconnect the four wires from the switch, and tag for later identification. To install the stop light switch, reverse the steps in the removal procedure. After installing, adjust the nut on each link rod so that switch contact is broken when the steering levers are in the forward position.

3-INCH GUN MOTOR CARRIAGE M10A1



RA PD 27705

**Figure 60—Stop Light Switch**

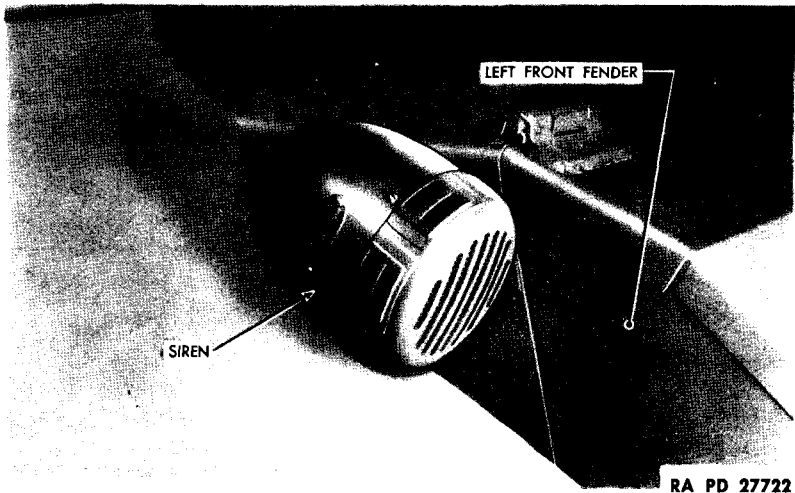
**105. COMPARTMENT LIGHT.**

a. A compartment light is provided on the ceiling in the center of the driver's compartment. It is provided with a toggle switch; however, the light is in series with the battery master switch which must be on before the light can be turned on. This light is equipped with a 24-volt, 3-candlepower, bayonet base bulb. To replace the compartment light lamp, remove the two screws that hold the bezel in place and remove the bezel and lens. Push lamp in and turn slightly to the left and withdraw lamp. To install lamp, reverse the removal procedure.

**106. INSPECTION LIGHT.**

a. Shielded inspection light with a 15-foot cord is provided as part of the equipment of the vehicle. The light may be plugged into a utility socket in the junction box at the rear of the engine compartment to the left of the oil level bayonet gage (accessible after the engine compartment rear door is opened) or in the instrument panel utility sockets (fig. 6).

## ELECTRICAL SYSTEM AND EQUIPMENT



**Figure 61—Siren**

### 107. SIREN.

a. A siren, operated by a foot switch (fig. 7) in the driver's compartment, is mounted on the left front fender (fig. 61). To remove the siren, disconnect the conduit coupling from the connector in the front armor sloping plate and pull out the plug. Remove the two nuts holding the siren bracket to the fender. Remove the siren. To install, reverse the above procedure.

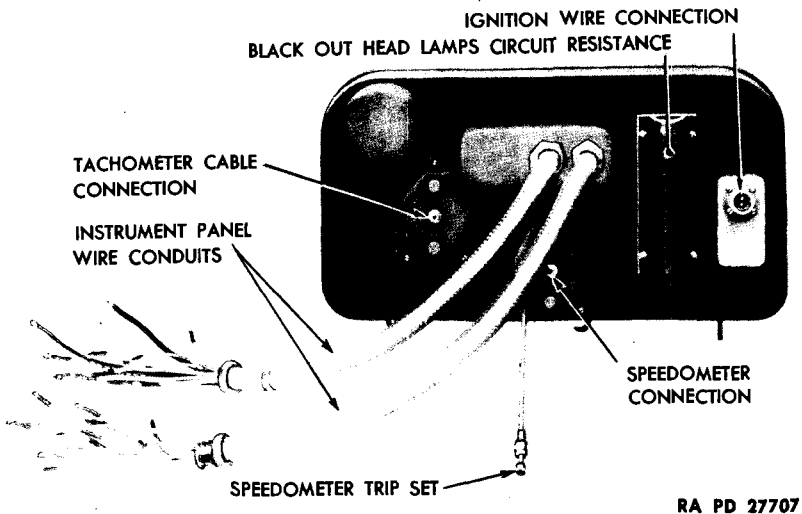
### 108. CONDUITS AND WIRES.

a. **Description.** The conduits protect the insulation of the wire against wear and abrasion, and are oil and water spray proof. Radio interference is cut to a minimum because the conduits provide a continuous grounded circuit over the entire wiring system. Figure 62 shows the conduits for the instrument panel wires. These are typical of the various conduits used throughout the vehicle.

b. **Maintenance.** Inspect all conduits for wear and abrasion, loosening of coupling nuts, and loose or missing conduit support clamps or brackets. Clean all dirty conduits. In cleaning couplings use dry-cleaning solvent. After cleaning and drying, the threads of each coupling and connector should be cleaned with a wire brush to remove oxidation which sometimes forms on the threads of aluminum couplings. This oxidation, particularly on the ignition harness fittings, breaks the grounded circuit and causes radio interference.

c. **Replacement.** Replace wires that show broken or hardened insulation at points of extrusion from a conduit, or that have become

### 3-INCH GUN MOTOR CARRIAGE M10A1



RA PD 27707

**Figure 62—Instrument Panel Case—Back**

oil-soaked through failure of a conduit. If the conduit is badly crushed, replace that section of the conduit and the wires contained therein. Before disconnecting any wire from the circuit, fasten a tag to the terminal post being worked on, stating the number of wires, size and color of the wire, and where the other end of the wire is connected. If this precaution is not followed, it will be necessary to consult the wiring diagrams (figs. 49 and 54) and trace out the circuit.

(1) **REMOVAL.** Disconnect the conduit couplings and the enclosed wires. Remove bracket or clamp supporting the conduit. Attach a piece of strong twine to the end of each wire before removing the wire from the conduit. The twine can be used in pulling cleaning cloths through a dirty but otherwise serviceable piece of conduit.

(2) **INSTALLATION.** Use only standard automotive ignition or primary wire of the same size and color as the wire removed. The wire may be pulled through the conduit by means of the heavy twine left in the conduit when the defective wire was withdrawn. Clean terminal posts and wire terminals before connecting any wire into its circuit. If the tags or marks on terminals are missing, consult the wiring diagram (figs. 49 and 54).

#### 109. TROUBLE SHOOTING.

a. **Ignition Trouble Shooting.** Ignition trouble shooting is covered under paragraph 36.

b. **Low Tension Circuit Trouble Shooting.**

(1) **GENERAL.** In the following discussion the generator, generator regulator, and the battery are assumed to be in operating condition.

## ELECTRICAL SYSTEM AND EQUIPMENT

The functions of these units are discussed in paragraphs 72, 74, and 76 respectively. Trouble shooting for the generating system is covered in paragraph 71 d. In the balance of the electrical system, two general types of electrical trouble are open circuits (par. 109 b (3)) and short circuits (par. 109 b (2)).

(2) **SHORT CIRCUITS.** Short circuits occur when for some reason the current is bypassed back to the battery through ground instead of through the unit for which it was intended. Quite often sufficient current passes through the defect in the circuit to start the insulation burning which permits easy location of the trouble. In other cases where there is considerable electrical resistance in the circuit, the amperage will be so low that a fire will not be started. These shorts can be located by checking the various portions of the circuit by placing a voltmeter parallel to the wire to be tested (circuit turned on). A short circuit will be indicated by voltage reading being considerably lower than battery voltage. Check various portions of the circuit until the defective wire is located.

(3) **OPEN CIRCUITS.** Open or partially open circuits cut off, or reduce the current in the circuit. Open or high resistance circuits can be located by placing a voltmeter parallel to the portion of the circuit to be tested with the circuit turned on. If the circuit is open, a reading of full battery voltage will be obtained. If the circuit is of high resistance, the reading will be almost full battery voltage. The amount of the voltage drop will vary for the various circuits depending on the normal resistance of the particular circuit being tested. The reading likewise will be controlled by the sensitivity of the voltmeter being used. Conditions to look for in locating electrical troubles are, in the order of their probability, as follows:

- (a) Loose, dirty, or corroded connections.
- (b) Inoperative or defective equipment.
- (c) Defective or corroded switches and plug connectors.
- (d) Worn conduits and broken or bare wires.

### 110. WIRING.

a. The wiring diagrams (figs. 49 and 54) give the wire size and color used in the various circuits. When it is necessary to install new wires, it will be necessary, generally, to solder the terminals on the wire after the wire has been installed in the conduit. The color scheme should be adhered to, and do not, for any reason, change the wire size in any portion of a circuit. Tag all wires during change. In stripping insulation from a wire to make a connection, do not damage the wire. Allow 3 or 4 inches of slack in installing the wires to switches where the terminals must be clipped off in order to replace the defective switch. Since oil and gasoline are injurious to insulation, keep all exposed wires clean, and check frequently for loose or corroded connections.



3-INCH GUN MOTOR CARRIAGE M10A1

Section XVI

NONELECTRICAL INSTRUMENTS

	Paragraph
Clock .....	111
Speedometer .....	112
Tachometer .....	113
Turret compass .....	114

**111. CLOCK.**

a. **Description** (fig. 6). The clock (8-day type) is located in the left center of the instrument panel. A reset and rewind knob is located at the bottom of the dial.

b. **Clock Replacement.** To remove the clock, remove the instrument panel (par. 80 b). Remove the two wing nuts from the clock clamp at the rear of the panel (fig. 55). Remove the clock from the front of the instrument panel. To reinstall, reverse the sequence of the steps in the removal procedure.

**112. SPEEDOMETER.**

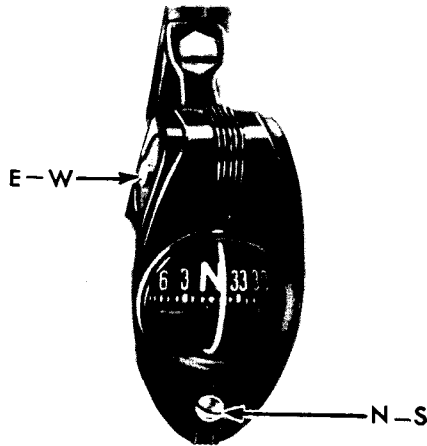
a. **Description** (fig. 6). The speedometer is located in the center of the instrument panel at the bottom and is equipped with a trip mileage reset. The speedometer consists of three units, the head, the drive cable, and the drive unit.

b. **Speedometer Head Replacement.** Remove the instrument panel (par. 80 b). Disconnect the speedometer cable by unscrewing the knurled nut at the back of the speedometer head (fig. 55). Disconnect the trip set from the clip at the bottom of the instrument panel. Remove the two wing nuts from the speedometer clamp (fig. 55), and remove the speedometer head from the front of the panel. Reinstall the head by reversing the sequence of the steps in the removal procedure.

c. **Speedometer Drive Cable Replacement.** Unscrew the knurled nut from the back of the speedometer head and disconnect the drive cable. Unscrew the knurled nut holding the cable housing to the speedometer drive gear housing located on right rear side of transmission (fig. 13), and disconnect the drive cable. Pull the cable out of housing from the instrument panel end. Reinstall the cable by reversing the sequence of the steps in the removal procedure.

d. **Speedometer Drive Unit Replacement.** The speedometer drive unit is located at the right-hand side of the transmission (fig. 13). To remove, unscrew the knurled nut holding the drive cable to the drive unit and disconnect cable. Unscrew the 1-inch nut which secures

**NONELECTRICAL INSTRUMENTS**



RA PD 27418

**Figure 63—Turret Compass**

the drive unit to the transmission and remove the drive unit. To reinstall, reverse the sequence of the steps in the removal procedure.

**113. TACHOMETER.**

**a. Description (fig. 6).** The operation and use of the tachometer is explained in paragraph 5 a (10). The tachometer consists of three units, the head, the cable, and the drive unit.

**b. Tachometer Head Replacement.** To remove the head remove the instrument panel (par. 80 b), unscrew the knurled nut from the back of the tachometer and disconnect cable. Remove the two wing nuts at rear of the instrument (fig. 55) and remove tachometer head from the front of the panel. To reinstall, reverse the sequence of the steps in the removal procedure.

**c. Tachometer Drive Cable Replacement.** To remove the tachometer drive cable, unscrew the knurled nut from the drive unit located on the left bank of the engine and disconnect the cable. Unscrew the knurled nut holding the cable housing to the tachometer head and disconnect the cable. Pull the cable from the housing. To reinstall the cable, reverse the sequence of the steps in the removal procedure.

**d. Tachometer Drive Unit Replacement.** To remove the tachometer drive unit (fig. 22) which is located on the rear end of the left-hand camshaft housing, unscrew the knurled nut which secures the drive cable housing to the drive unit. Disconnect the drive cable housing. Unscrew the 1-inch nut which holds the tachometer drive unit to the camshaft housing. Remove the drive unit. To reinstall, reverse the sequence of the steps in the removal procedure.

## 3-INCH GUN MOTOR CARRIAGE M10A1

## 114. TURRET COMPASS.

a. **Description** (fig. 63). The turret compass is rubber-mounted to decrease vibration.

b. **Compensation** (fig. 63).

(1) **GENERAL INSTRUCTIONS.** To overcome the magnetic effect of the steel and electrical equipment in the vehicle, it is necessary to compensate the compass. Use a coin to make adjustments. Do not use a screwdriver as it may be magnetic. Before beginning compensation, be sure the compensator screw slots marked "N-S" and "N-W" are in approximate vertical position.

(2) **ADJUSTING COMPASS.**

(a) *Head the Vehicle North and Adjust.* Head the vehicle north, turn the lower compensator screw slot marked "N-S", slightly if necessary, to make the dial read "NORTH" or "SOUTH", no farther.

(b) *Head the Vehicle East and Adjust.* Head the vehicle east, turn the upper compensator screw slot marked "E-W", slightly if necessary, to make the dial read "EAST", no farther.

(c) *Head the Vehicle South and Adjust.* Head the vehicle south, turn the lower compensator screw slot marked "N-S", slightly if necessary, to make the dial read "SOUTH".

(d) *Head the Vehicle West and Adjust.* Head the vehicle west, turn the upper compensator screw slot marked "E-W", slightly if necessary, to make the dial read "WEST".

(3) **CORRECTING ADJUSTMENT.** If the dial reads "SOUTH" instead of "NORTH", completion of step (2) will correct this condition. If the north or south is slightly off, correct by turning the lower screw marked "N-S". If the east or west is slightly off, correct by turning the upper screw marked "E-W". Do not turn upper screw for north or south adjustment. Do not turn lower screw for east or west adjustment.

(4) **DRIFT.** Do not make adjustments in a steel building or near heavy electrical equipment. In some instances, the magnetic characteristics of heavy vehicles are such that, after the compass is compensated, the dial is inclined to drift by one of the cardinal points. The condition can be corrected by turning one of the compensator screw slots one-half turn (approximately 180 degrees) and recompensating the compass.

(5) **COMPASS DRIFT ADJUSTMENT.** If the compass is inclined to drift by the "NORTH" or "SOUTH", the upper compensator screw slot marked "E-W" should be turned over and the compass recompensated. If the drift is on "EAST" or "WEST", turn the lower compensator screw marked "N-S" one-half turn and recompensate the compass.

Section XVII

CLUTCH, PROPELLER SHAFT, AND UNIVERSAL JOINTS

	Paragraph
Clutch .....	115
Propeller shaft and universal joints .....	116
Accessory drive shafts and universal joints .....	117

**115. CLUTCH.**

**a. Description.** The clutch is of the double plate standard automotive type composed of three major units, the pressure plate assembly, the center drive plate, and the two driven plates or disks (fig. 64). The two driven plates have friction facing riveted on each side. The release fork and the release levers are mounted on needle roll bearings.

**b. Pedal Stroke Adjustment.** Set the pedal stroke adjustment stop screw so that the highest point of the clutch pedal pad is 16 inches (plus or minus 1/8 inch) from the hull floor (fig. 65).

**c. Clutch Pedal Rod Adjustment.** Check the length of the rod running from the clutch pedal to the cross shaft and readjust its length if necessary. This rod should be 15 1/4 inches long measured from the center of one clevis pin hole to the other. The length of this rod may have been changed by some one who did not know how to make this adjustment correctly. If this length is not held to 15 1/4 inches, the angle of the levers on the cross shafts will be changed affecting the operation of the clutch pedal.

**d. Free Travel of Clutch Pedal Adjustment.** The free travel of the clutch pedal is determined by the clearance between the clutch release bearing and the clutch release fork. Clearance must exist between these parts at all times, otherwise the clutch will slip and burn out. Driving with the foot on the clutch pedal takes up this clearance with the same result. As the clutch disk facings become worn, the pedal free travel decreases. When the free travel of the pedal drops to less than 2 inches measured at the pedal pad, it must be adjusted to 3 1/2 inches (fig. 66). The adjustment is made by lengthening or shortening the rod connecting the clutch cross shaft to the clutch release lever on the engine by means of the clevis on the front end of this rod (fig. 65). Lengthening this rod increases, and shortening this rod decreases the free play of the pedal. This adjustment must be made through the propeller shaft housing. If unable to get more than 2 inches free play, the clutch plates are worn and must be replaced.

**e. Clutch Drag.**

(1) **GENERAL.** If, after holding pedal all the way down for a few seconds, the gears clash when shifting into first or release gear, the clutch is dragging. **NOTE:** There is a tendency for the clutch driven shaft to turn over slowly when clutch is released; this is normal and

3-INCH GUN MOTOR CARRIAGE M10A1

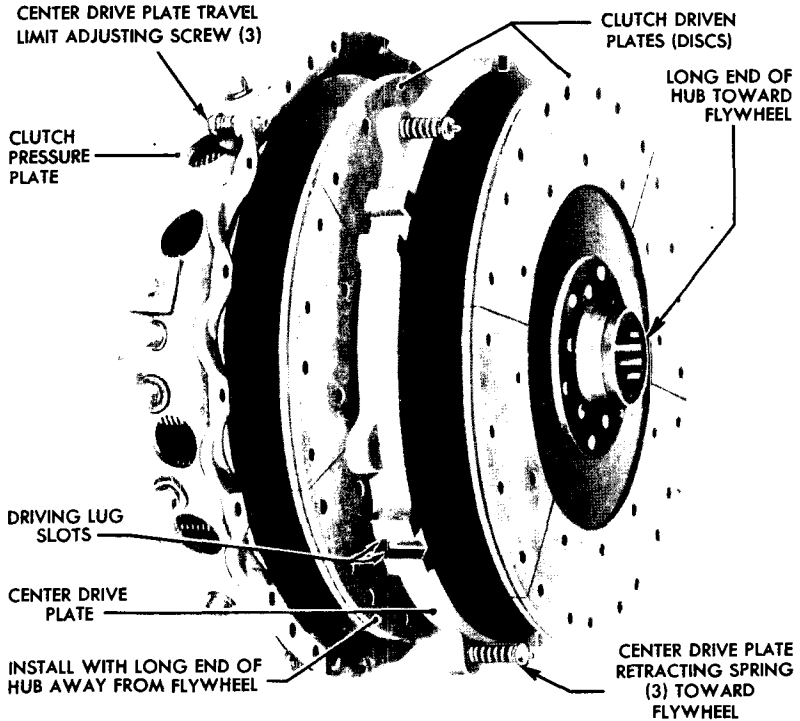


Figure 64—Clutch

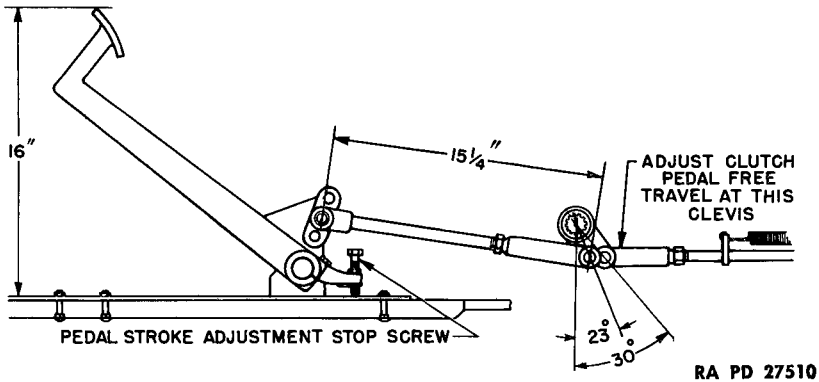
RA PD 27505

will not cause any noticeable clashing. Check the pedal stroke adjustment (par. 115 b) and the free travel of pedal adjustment (par. 115 d). If these adjustments are satisfactory, check adjustment of the three center drive plate travel limit screws (fig. 67).

(2) **PRELIMINARY STEPS.** Remove the inspection plate from the cover over the left side of the clutch housing (accessible from fighting compartment). Make sure the engine ignition switch is off. Turn the engine with the starter until one of the center drive plate limit screws appears at the opening as shown in figure 67. To prevent the engine from spinning and in order to permit stopping the engine with the desired adjusting screw at the opening, set the gear shift lever in high gear. With one man watching the opening for the adjusting screws, another man should press the starter button intermittently until the first center drive plate travel adjusting screw appears at the inspection opening (fig. 67). Since the transmission will be in gear, the vehicle will move slightly as the engine is turned.

(3) **CENTER DRIVE PLATE TRAVEL LIMIT ADJUSTMENT.** With a screwdriver, turn the center drive plate travel limit adjusting screw in (clockwise) until it bottoms lightly; then turn back four notches

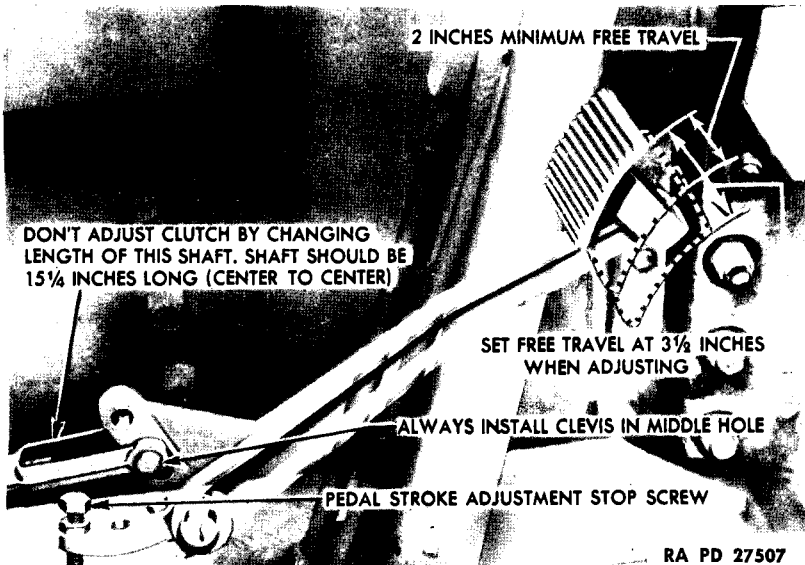
**CLUTCH, PROPELLER SHAFT, AND UNIVERSAL JOINTS**



**Figure 65—Clutch Pedal Linkage**

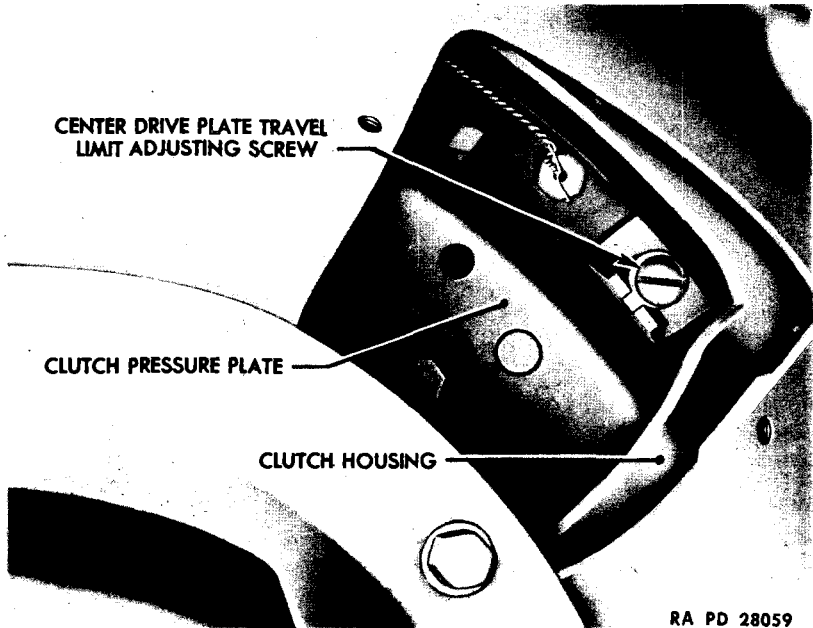
(counterclockwise). Repeat the above procedure for the two remaining adjusting screws. If this adjustment fails to correct the trouble, repeat the adjustment, backing off the screws five notches instead of four. If still unsatisfactory, the probable trouble is that the center plate is binding on the flywheel drive lugs, the pilot bearing in the flywheel is binding, the clutch disk splined hubs are too tight on the clutch shaft, or the driven plates are warped, any of which requires the removal of the clutch (par. 115 g).

**f. Pedal Pressure Too Stiff.** If pedal pressure is too stiff, the following points should be checked: Check the position of the clutch



**Figure 66—Clutch Pedal Adjustment**

3-INCH GUN MOTOR CARRIAGE M10A1



RA PD 28059

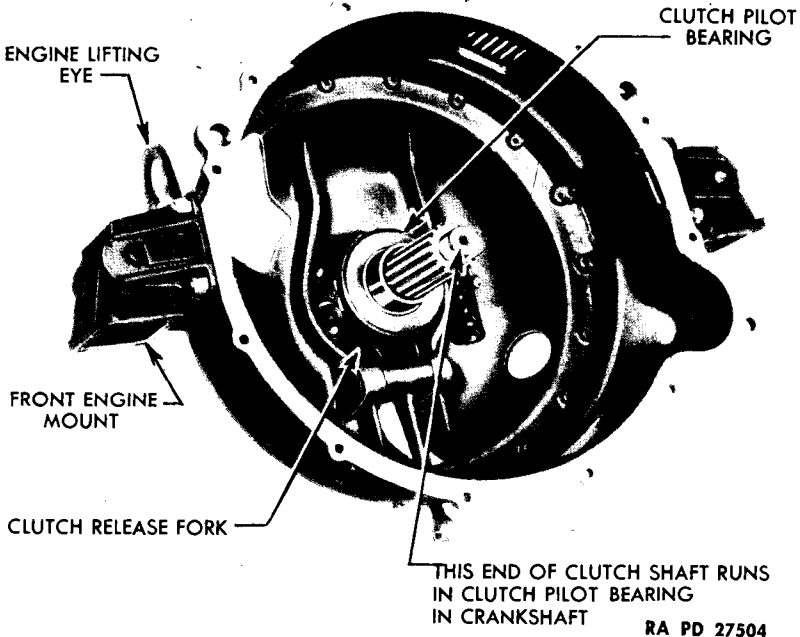
**Figure 67—Inspection Plate Removed from Left Side of Clutch Housing**

pedal rod clevis at the pedal. The clevis should be in the middle hole as shown in figure 65. Check the length of the clutch pedal to clutch cross shaft rod measuring from the center of one clevis hole to the other and if incorrect, adjust to exactly  $15\frac{1}{4}$  inches. Make sure that the linkage is not binding from lack of lubrication. Check the positions of the levers at inner or outer end of the clutch cross shaft to make certain that they are not at an angle too far forward. Inner lever at center of tank should be approximately 30 degrees to rear of the vertical center line of the cross shaft and the outer lever near the side of the vehicle should be approximately 23 degrees to rear of the vertical center line.

**g. Clutch Replacement.**

(1) **REMOVAL.** Remove engine as outlined in paragraph 37 b. Place the engine on a stand (41-S-494-14) using adapter (41-A-18-100) so that front end will be supported after the clutch housing is removed. Remove the starting motor (par. 78 b). Remove the clutch housing (fig. 68) by removing the 12 flange nuts. To hold clutch springs compressed while the clutch pressure plate is removed, use six  $\frac{3}{8}$ -inch, 16-thread  $1\frac{1}{2}$ -inch long cap screws, screwing them in the holes in pressure plate assembly until the heads just bottom (fig. 69). Install the clutch pilot tool (41-T-3083-75) to keep the clutch

**CLUTCH, PROPELLER SHAFT, AND UNIVERSAL JOINTS**



**Figure 68—Clutch Housing**

disk splines in alinement (fig. 69) and also prevent clutch disk from falling and possibly injuring your feet. Remove the lock wire from the 18 cap screws holding the pressure plate to the flywheel, and remove the cap screws and the pressure plate (fig. 64). Remove center drive plate from the driving lugs in the flywheel.

**(2) INSTALLATION.**

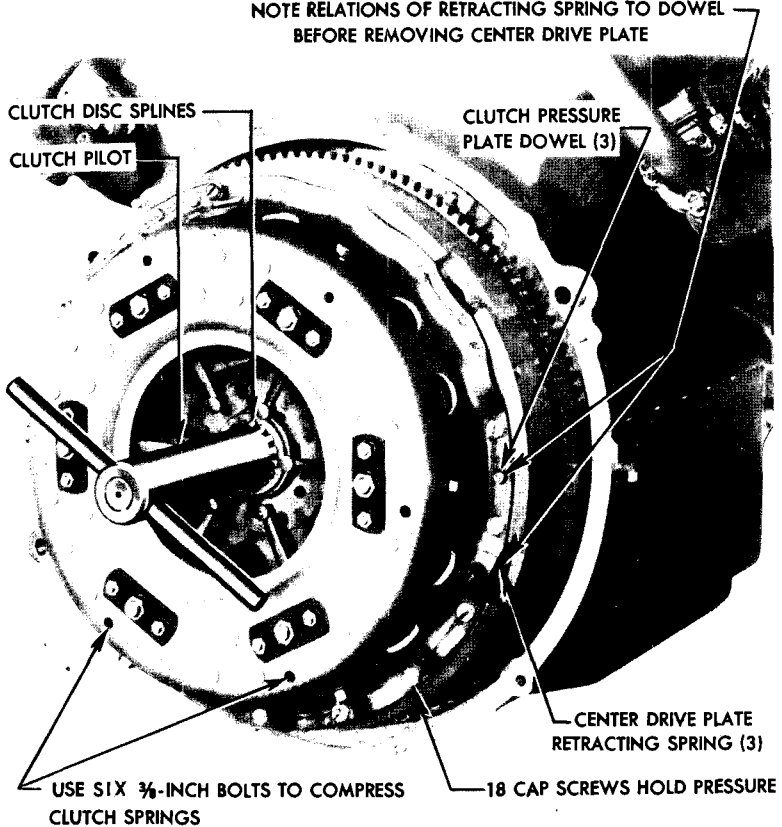
**(a) Preliminary Steps.** See that the friction surface of the flywheel is smooth and clean. Any deposits on the friction surface must be sanded down and the surface cleaned with gasoline or cleaning fluid. If the clutch shaft pilot bearing is in good condition, repack with a high melting point grease.

**(b) Install Clutch Disks and Center Drive Plate.** Place one driven member (disk) in place with long end of the hub toward the flywheel (fig. 64). Insert the center drive plate with the retractor spring (fig. 64) toward the flywheel making sure the driving lug slots fit freely on the driving lugs in the flywheel. Install the center drive plate on the flywheel lugs, which will position the retractor springs in line with the three openings in the flywheel nearest to the three dowel pins in the flywheel rim. This will bring the retractor springs in line with the three adjusting screws in the pressure plate assembly. Using the clutch pilot



### 3-INCH GUN MOTOR CARRIAGE M10A1

NOTE RELATIONS OF RETRACTING SPRING TO DOWEL  
BEFORE REMOVING CENTER DRIVE PLATE



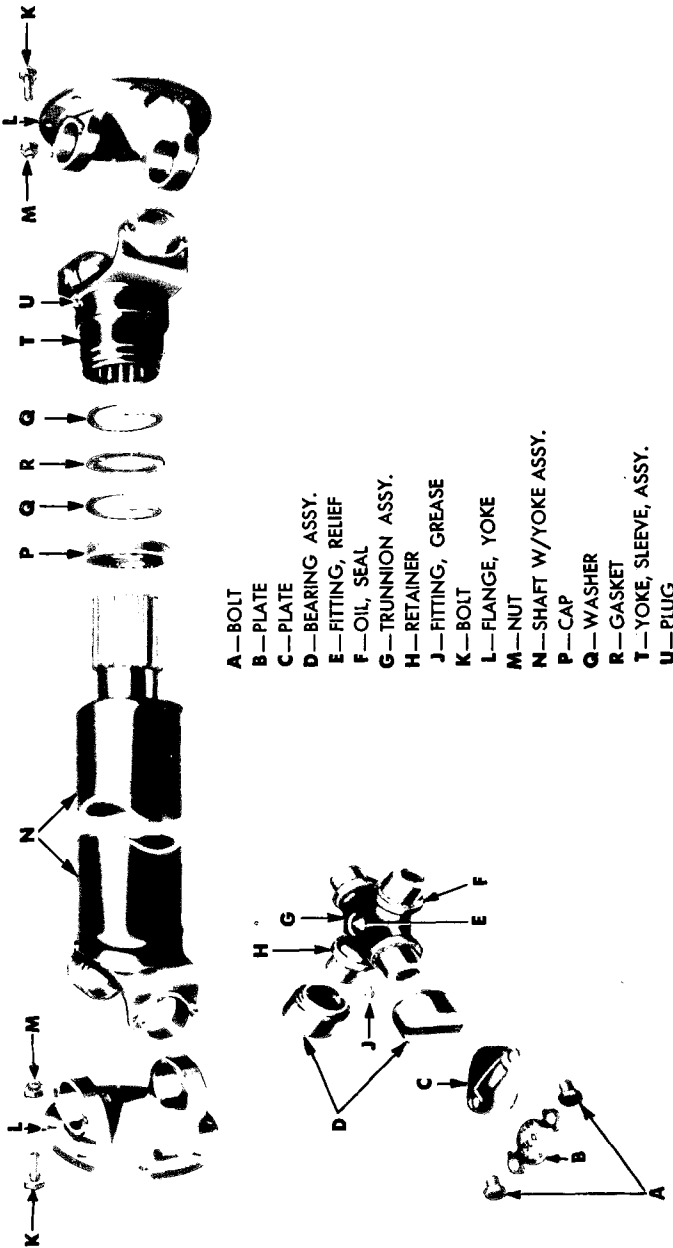
RA PD 65936

**Figure 69—Clutch with Clutch Housing Removed**

tool (41-T-3083-75) (fig. 69), slip it through splined hub of the disk and into the clutch shaft pilot bearing. Remove handle from the pilot tool. Slip the second disk on the pilot with the long end of its hub away from the flywheel. This aligns both driven members with each other and the clutch shaft pilot bearing while the pressure plate assembly is being attached.

(c) *Install the Clutch Pressure Plate.* Install the clutch pressure plate assembly so that the dowel holes line up and install the 18 cap screws which hold it to the flywheel. Wire the cap screws to prevent their loosening. Start the wire at the cap screw nearest clutch center drive plate travel limit adjusting screw, and lock it with the next nearest cap screw. Proceed with the next two until they all have been locked together in pairs. Remove the six  $\frac{3}{8}$ -inch cap screws used to hold the pressure plate compressed (fig. 69).

CLUTCH, PROPELLER SHAFT, AND UNIVERSAL JOINTS



- A—BOLT
- B—PLATE
- C—PLATE
- D—BEARING ASSY.
- E—FITTING, RELIEF
- F—OIL, SEAL
- G—TRUNNION ASSY.
- H—RETAINER
- J—FITTING, GREASE
- K—BOLT
- L—FLANGE, YOKE
- M—NUT
- N—SHAFT W/YOKE ASSY.
- P—CAP
- Q—WASHER
- R—GASKET
- T—YOKE, SLEEVE, ASSY.
- U—PLUG

RA PD 27511

Figure 70—Propeller Shaft and Universals—Exploded Views

**3-INCH GUN MOTOR CARRIAGE M10A1**

(d) *Adjust Center Drive Plate Travel Limit.* Adjust the three center drive plate travel limit adjusting screws (fig. 69) with a screwdriver by turning clockwise until they bottom lightly; then turn back four notches.

(e) *Subsequent Steps.* Remove the clutch pilot tool (fig. 69). Install the clutch housing (fig. 68). Install the starter (par. 78 b).

**h. Clutch Release Bearing or Fork Replacement** (fig. 68). To remove clutch release bearing or fork, remove clutch housing (par. 115 g (1)). Disconnect the two springs which hold the release bearing and fork in contact. Slide the release bearing off the hub. To remove the clutch fork, remove one lock ring on either end of the shaft running through the clutch fork and slide the shaft out of the housing. Remove the fork from the housing. To reinstall, reverse the sequence of the steps in the removal procedure.

**116. PROPELLER SHAFT AND UNIVERSAL JOINTS.**

**a. Propeller Shaft.**

(1) **DESCRIPTION** (fig. 70). The propeller shaft transmits power from the engine to the transmission at the front of the vehicle. The propeller shaft is covered by a housing or tunnel underneath the turret platform.

(2) **REPLACEMENT.**

(a) *Removal.* Remove the engine from the vehicle (par. 37 b). Remove the inspection cover from the housing over the front universal joint. Unscrew the grease seal retainer at the front universal slip joint. Pull the propeller shaft to the rear out of the "tunnel" (the front end of the shaft will pull out of the slip joint in the front universal joint, leaving the front universal on the transmission). Remove the bolts from the front universal and remove the universal from the transmission. Install it on the propeller shaft just removed.

(b) *Installation.* Remove the front universal from the propeller shaft and install it on the transmission. Slip the propeller shaft through the tunnel and connect the front universal joint to the propeller shaft at the splined slip joint. An arrow mark is placed on both the front universal joint and on the propeller shaft. These arrows must be lined up before assembly of universal joint to the propeller shaft, so as to establish the front and rear universal joint yokes in line with each other to prevent vibration of the propeller shaft. Screw the grease seal retainer cap (fig. 70) on the front universal joint, making sure the cork ring and snap ring washers are not damaged. Reinstall the engine (par. 37 c) and bolt the rear universal joint to the clutch flange. Depress the clutch and turn the propeller shaft to install all the bolts.

**b. Propeller Shaft Universal Joints.**

(1) **DESCRIPTION.** Two universal joints are used with the propeller shaft, one at each end. The front one is connected to the shaft through

## CLUTCH, PROPELLER SHAFT, AND UNIVERSAL JOINTS

a splined slip joint. The yoke for the rear universal joint is part of the shaft. Four needle roller bearings are used in each universal joint. The bearings and the seals in the universal joints are the parts most likely to wear out. Excessive bearing wear is indicated by propeller shaft vibration. When vibration develops, notify ordnance maintenance personnel before the universal joints require replacement. Universal joint bearings can be replaced by ordnance maintenance personnel without removing the universal joints, if the need is detected in time. Thus, saving the removal of the engine. The procedure to be used by ordnance maintenance personnel in replacing the bearings is as follows:

### (2) REPLACEMENT OF PROPELLER SHAFT UNIVERSAL JOINT BEARINGS.

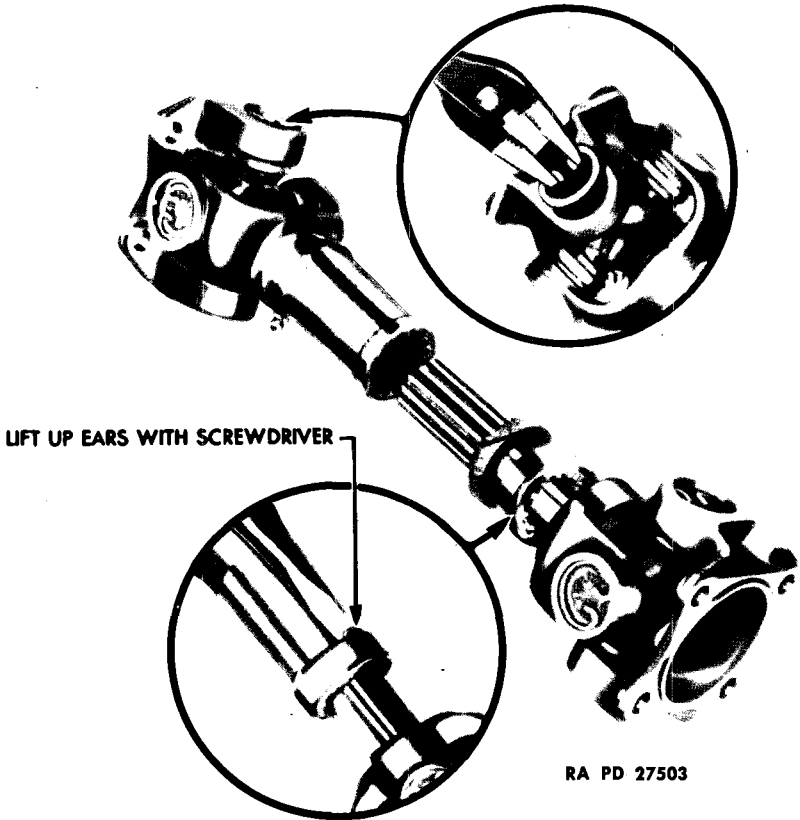
(a) *Removal* (fig. 70). To remove the bearings in the propeller shaft universal joint front or rear, remove tunnel inspection covers over the front and rear universal joints. Hold down the clutch pedal and have the transmission in neutral to free the propeller shaft, and turn shaft until the universal joint lubrication fitting is accessible. Remove the fitting. Remove the universal joint bearing cover plate by bending down the locking ears and removing the bolts. Hold down the clutch pedal and turn the propeller shaft one-half turn. Remove the opposite bearing cover which now faces up. Use a brass or copper drift, and tap the bearing down until the trunnion forces the bottom bearing to drop out. Hold the clutch pedal down, and turn propeller shaft one-half turn. Drive the universal joint trunnion down, using a brass or copper drift until the other bearing is forced out of yoke. Follow the same procedure to remove the other two bearings.

(b) *Installation* (fig. 70). Examine the cork seal and retainer of each bearing and replace if necessary. Place the trunnion in the yoke and push it through the yoke so that the bearing can be set in place on the trunnion; then drive the bearing lightly into the yoke on the propeller shaft until the bearing is flush. Assemble the cover plate to the slot in the bearing, and line up the bolt holes in the cover with the holes in the yoke. Install the two cap screws and lock plate. Reverse the universal joint and enter the opposite bearing on the trunnion. Drive the bearing lightly into the yoke. Line up the slot in bearing and the cover and install cover. Bend up one ear of the lock plate against each of the cap screw heads (at each plate). Repeat the above procedure for the other two bearings.

## 117. ACCESSORY DRIVE SHAFTS AND UNIVERSAL JOINTS.

a. *Accessory Drive Shafts* (fig. 71). The accessory drive shafts provide a connection between the driving flange on the accessory gear assembly at the rear of the engine and the flange on the accessory drive housing, one on each side of the engine. Two universal joints are used on each shaft. To remove the shafts, remove the four bolts from each flange.

3-INCH GUN MOTOR CARRIAGE M10A1



**Figure 71—Accessory Drive Shaft**

b. Accessory Shaft Universal Joints (fig. 71). Two universal joints are used on each shaft, one at each end. Four needle roller bearings are provided in each universal joint. Accessory drive shafts are supplied as an assembly with the universals in place.

Section XVIII

**POWER TRAIN (TRANSMISSION, DIFFERENTIAL, AND FINAL DRIVE)**

	Paragraph
Power train unit .....	118
Transmission .....	119
Differential .....	120
Final Drive .....	121
Transmission oil cooler.....	122
Steering brakes .....	123
Parking brake .....	124

**118. POWER TRAIN UNIT.**

a. **General Description.** The power train unit comprises the transmission, differential, and final drives, all lubricated by a single oil circulating system, including a pump and an oil cooler. For details of adjustment and maintenance operations on the final drive unit assemblies refer to TM 9-1750.

b. **Power Train Lubrication.** The entire power train unit, which includes the transmission, differential, and two final drives, is lubricated by a single oiling system. An oil pump, inside the transmission case, draws oil from a sump in the bottom of the differential housing and forces it through an outlet on the left side of the transmission case. From this outlet the oil is forced through hose lines and tubes to the oil cooler, through which it circulates, and then is returned to an oil gallery in the transmission. From the transmission, the oil passes (through openings in the front wall of the transmission case) to the differential housing and the final drive units (fig. 74), from which it is again drawn out by the pump to begin another cycle. An oil line from the T-connection in the return line from the cooler, leads to the differential carrier, where it delivers a constant stream of cooled oil to the ring gear and pinion. The power train is filled with lubricating oil at the filler on the right side of the transmission case (fig. 13).

c. **Checking Oil Level.** A bayonet type measuring gage, or dip stick, for measuring the oil level, is attached to the filler cap. To measure the oil level, remove the cap, wipe off the gage; then insert it into the transmission case as far as it will go, with the cap merely resting on top of the filler opening. Do not screw the cap in. To determine accurately the level of oil in the power train, place the vehicle on level ground. If the oil level is to be checked immediately after the vehicle has been operated, wait at least 5 minutes to allow the oil to settle. The full oil level should be maintained by frequent checking and adding oil as required. Too much oil will cause overheating.

d. **Draining Power Train.** To drain the power train requires the

**3-INCH GUN MOTOR CARRIAGE M10A1**

removal of three drain plugs, two underneath the differential housing (one at each side), and one on the bottom of the transmission housing, accessible only through a hole in the plate on the underneath side of the hull floor.

**e. Refilling Power Train.** If the power train has been drained, refilling requires special procedure. After putting in oil to raise the level to the "FULL" mark, operate the vehicle until the oil is warmed up; then stop the vehicle and allow 5 minutes for the oil to drain back to the transmission. Again check the oil level, and add oil up to the "FULL" mark. If, after the correct measured quantity of oil has been put into a drained power train, the level does not come up to the "FULL" mark, it is because the oil has not yet fully drained back from the system after the warming up run.

**f. Replacement of Power Train Unit.**

(1) **EQUIPMENT.** Besides the necessary hand tools, this operation requires a power train carrier (fig. 72) and a second vehicle or wrecker for towing. The vehicle being repaired must be on a firm and level surface.

**(2) PROCEDURE.**

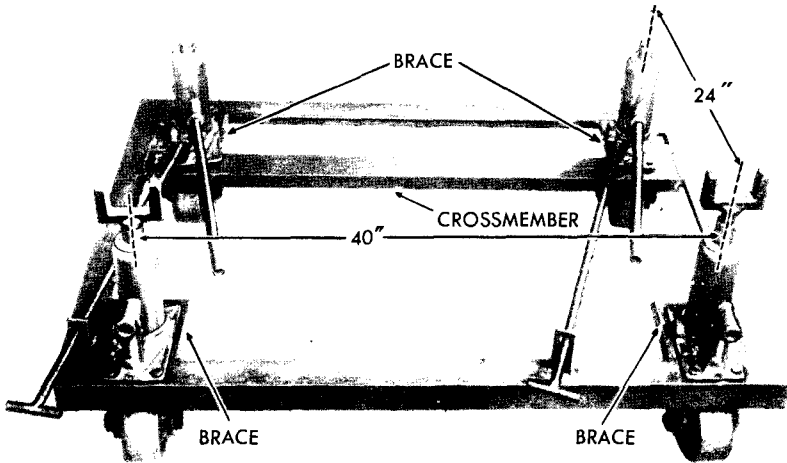
(a) *Removal of Exterior Parts.* If it is considered advisable to drain the power train before its removal, using a special  $\frac{9}{16}$ -inch hexagon wrench (41-W-878) remove the three drain plugs; one under each side of the differential housing and one under the transmission, and drain the unit. Break each track (par. 129 d), and remove the track from the drive sprocket. On earlier models where the siren is located on the fender, remove the bolts from the siren and remove the siren. Remove the bolts which hold each fender to the hull and final drive housing and remove the fenders.

(b) *Disconnect Drive Line.* Remove the bolts from the front propeller shaft housing and remove the housing. Remove the bolts from the propeller shaft front flange to disconnect the propeller shaft. Remove the cotter pins and clevis pins at the top ends of both steering lever linkage rods to disconnect them from brake shaft arms.

(c) *Remove Hand Throttle and Temperature Gage.* Remove the hand throttle (par. 56 b (2)). Disconnect the wire from the transmission oil temperature gage transmission unit (located on the left side of the transmission). Pass the gage wire under the steering lever cross shaft to clear, and tie up out of the way. Remove the transmission oil temperature gage transmission unit. Cover the opening in the transmission housing with tape to keep foreign matter out.

(d) *Remove Stop Light and Siren Switches.* Remove the nuts on the adjustable rods which connect the stop light switch to the brake shaft arms. Remove the two bolts from the stop light switch bracket on the left side of the differential housing. Remove the stop light switch.

**POWER TRAIN (TRANSMISSION, DIFFERENTIAL, AND FINAL DRIVE)**



RA PD 11073

**Figure 72—Power Train Carrier**

Remove the two nuts which hold the siren switch bracket and remove bracket. Wire siren switch bracket, siren switch, and stop light switch out of the way.

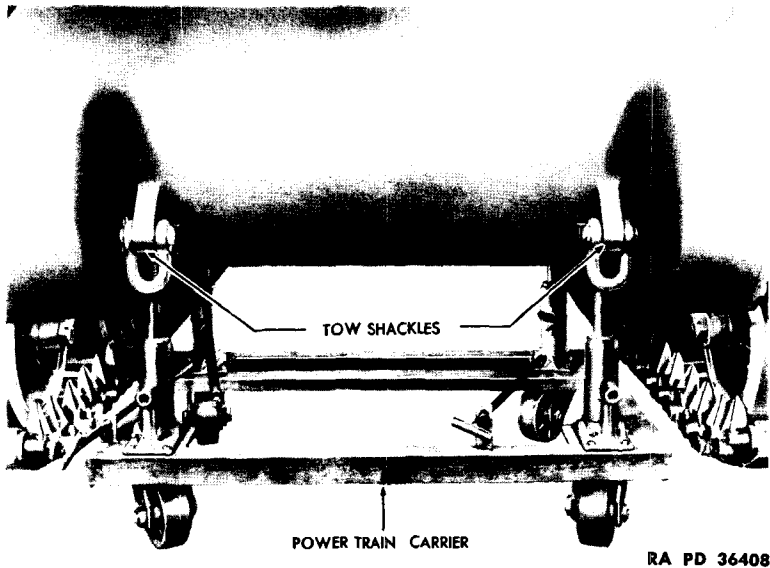
(e) *Disconnect Oil Cooler Lines and Speedometer Cable.* Disconnect the transmission oil cooler lines at the fittings on the transmission housing. Cover the fittings and the oil line couplings with cloth or tape. Disconnect the speedometer cable from the speedometer drive at the top right rear of the transmission housing by loosening the knurled nut. Pass the cable under steering lever cross shaft to clear and tie it up, out of the way. Tape the end of cable and the opening in the fitting.

(f) *Free Power Train Housing.* Remove the bolts and lock nuts which hold the lower edge of power train housing to the vehicle floor. Lock nuts must be held from inside the vehicle. With a man inside the vehicle holding the nuts, remove all the bolts from the sides and all except six bolts in the top, where the power train is joined to the hull. The bolts left in the top are to be evenly spaced. The upper corner bolts on each side are the only bolts with lock washers. Set the power train carrier (fig. 73) in place. Raise the jacks until they are solidly loaded, making certain that each is squarely in contact with a flat surface of the housing. Remove remainder of the bolts.

(g) *Separate Power Train from the Vehicle.* Place a 4- by 4-inch block, 14 inches long, in front of each rear wheel of the front bogie to keep the vehicle from rolling forward when removing the power train. Slowly raise each jack, in rotation, until the housing breaks free from the hull. Attach a towing cable to each towing shackle on the power train; then, with wrecker or other vehicle, pull the power train slowly forward and with extreme caution, on a straight line, away from the



3-INCH GUN MOTOR CARRIAGE M10A1



**Figure 73—Power Train Carrier in Place**

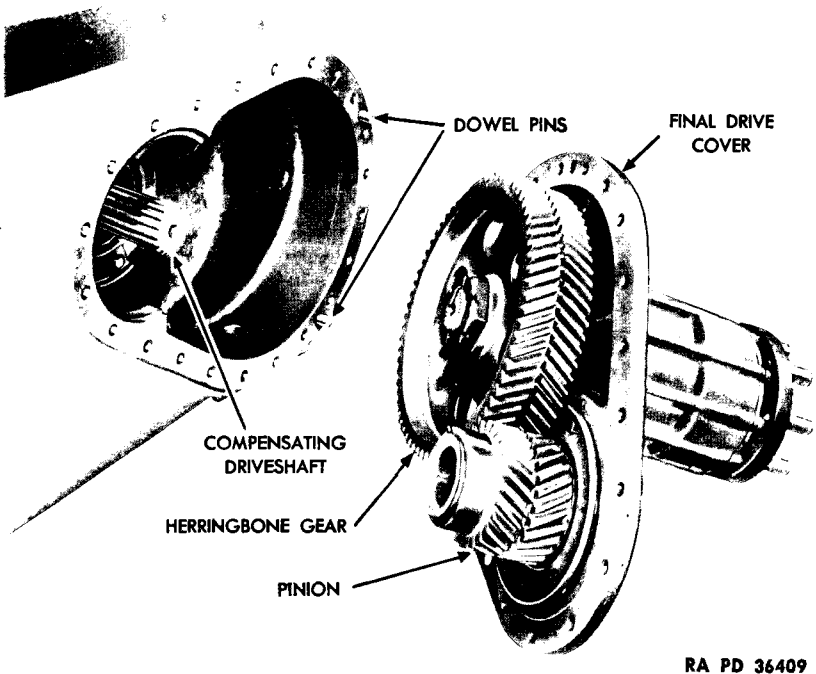
vehicle. **CAUTION:** Station a man inside the vehicle to see that the transmission and the gear shift lever, etc. clear and do not catch. Additional clearance for the levers may be gained by raising or lowering the jacks.

**g. Installing Power Train.** Reverse the sequence of the steps in the removal procedure except the following: Seal all attaching edges of power train with soft-drying mineral putty before installing in vehicle. Install and line up the side shims, holding them in place with soft-drying mineral putty. Line up the bolt holes in the power train with those in the hull side plates. This operation may require moving the power train slightly forward or backward, or raising or lowering the jacks. Use drifts to line up the holes. Place four equally spaced bolts in each side, and four equally spaced bolts across the top of housing to hold power train in line. Install the remainder of the bolts.

## 119. TRANSMISSION.

**a. Description.** The transmission is of the synchronized selective sliding gear type having five forward speeds and one reverse. Synchronizers are provided to facilitate shifting for all speeds except first and reverse. Gears for all speeds are in constant mesh. On earlier vehicles a parking brake, built into the transmission is operated by a lever to the right of the driver (fig. 7). This brake is to be applied only when the vehicle is at a standstill. The parking brake used on present vehicles is described in paragraph 5 b (7).

**POWER TRAIN (TRANSMISSION, DIFFERENTIAL, AND FINAL DRIVE)**



RA PD 36409

**Figure 74—Final Drive Unit Removed from Power Train**

**b. Transmission Replacement.** Remove the power train unit (par. 118 f). Install transmission lifting eye-bolts (41-B-1586-350) in the two holes provided at the top of the transmission housing and attach a suitable hoist to support the weight of the transmission. Remove the 19 nuts which secure the transmission housing to the differential housing and remove the transmission assembly. To install transmission, reverse the sequence of the removal operation, using new gaskets. **NOTE:** When a new transmission is to be installed, installation will be made by ordnance maintenance personnel.

**120. DIFFERENTIAL.**

**a.** The differential permits one track to move slower or faster than the other on turns. The operator can cause either track to run slower than the other by pulling back on the steering lever corresponding to the direction of the desired turn for steering the vehicle. When either steering brake lever is pulled back, it tightens the brake bands and slows or stops the brake drum on that particular side. This slowing or stopping of the brake drum and its compensating shaft slows down (but cannot stop) the track on the side of which the steering brake is operated, and causes a corresponding increase in the speed of the other track, so that the vehicle turns toward the side of the slower track.

### **3-INCH GUN MOTOR CARRIAGE M10A1**

Sharpness of the turn depends on the force with which the steering lever is pulled. If both steering levers are pulled back equally, the vehicle will slow or stop without turning to either side.

#### **121. FINAL DRIVE.**

**a. Description** (fig. 74). The final drives transmit power from the differential to the driving sprocket hubs. Each final drive unit has a pair of herringbone reduction gears, through which power from the compensating drive shaft of the differential is transmitted to the final drive shaft. The final drive shaft is flanged at its outer end and attached to the sprocket hubs by studs and nuts. The larger of the two herringbone gears is mounted on the final drive shaft, which is supported on two heavy-duty roller bearings in the final drive cover. The smaller gear, or pinion, is supported on a roller bearing at its outer end in the final drive cover, and at its inner ends on a roller bearing that fits around the outer end of the splined compensating drive shaft of the differential. The final drive cover is attached to the differential housing by bolts. The two driving sprockets for each track are bolted to a hollow hub which fits over the outer end of the final drive cover.

**b. Lubrication.** The gears and bearing of the final drive are lubricated by oil entering from the differential housing.

#### **c. Final Drive Replacement.**

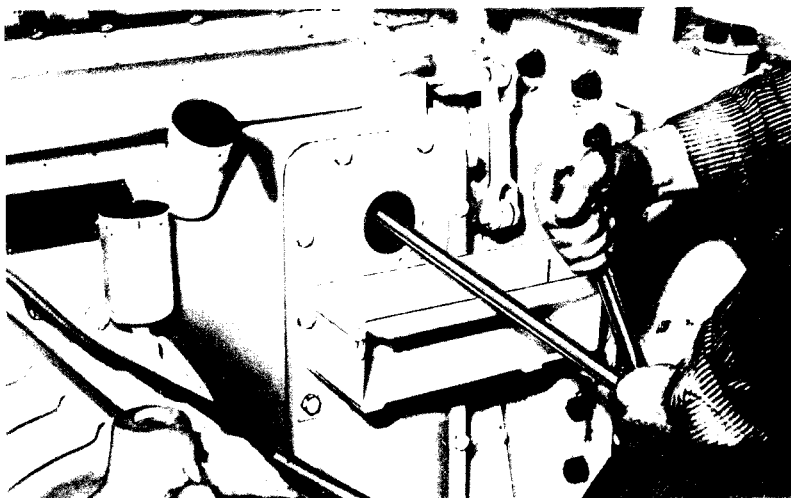
(1) **REMOVAL.** Drain the oil from the transmission, differential, and final drive. Remove the sprockets and hub assembly (par. 127 b). Arrange a hoist to support the final drive while it is being removed exerting just enough "lift" to take the weight off the attaching bolts and the dowel pins. Remove the bolts that attach the final drive unit to the vehicle. Pry the final drive unit away from the differential housing with a pinch bar. The unit must be carefully manipulated to withdraw it in a straight line away from the vehicle, in order that the herringbone pinion gear may slide straight off the splined end of the compensating drive shaft of the differential. Figure 74 shows final drive removed from power train.

(2) **INSTALLATION.** To install, reverse the sequence of the steps in the removal procedure, using a new gasket, and refill the power train unit with oil.

#### **122. TRANSMISSION OIL COOLER.**

**a. Description** (fig. 9). Because the oil in the power train absorbs not only the heat generated by the gears, but also that generated by the brakes in steering and stopping the vehicle, an oil cooler is provided. It is mounted on the top center of the engine bulkhead, inside the fighting compartment. A pump, within the transmission housing, forces the oil through the passages in the cooler. Air is drawn through the oil cooler core by the engine fans. Oil flows from pump to cooler

**POWER TRAIN (TRANSMISSION, DIFFERENTIAL, AND FINAL DRIVE)**



RA PD 36401

**Figure 75—Brake Adjustment**

and back to the transmission, through tubes running under the propeller shaft housing, on the hull floor.

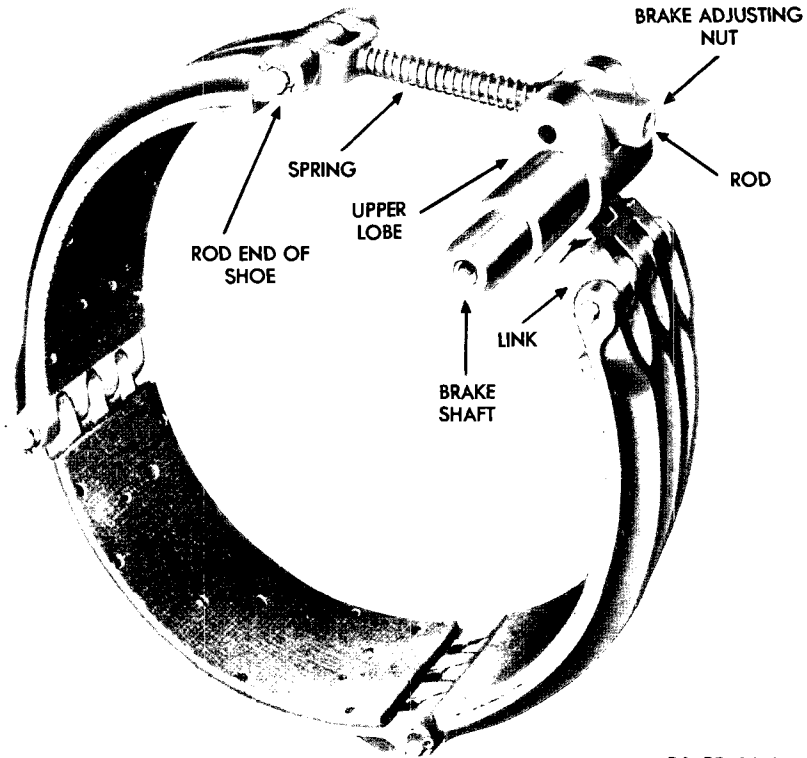
b. **Replacement of Oil Cooler (fig. 9).** To remove transmission oil cooler, disconnect oil inlet and outlet tubes at the oil cooler. Remove the four cap screws which hold the cooler guard and remove the guard. Remove the four bolts from the brackets at each end of the oil cooler and remove the oil cooler unit. To install the transmission oil cooler, reverse the removal procedure, making sure that the felt is in place between the bulkhead and cooler before fastening the cooler to the bulkhead.

c. **Replacement of Oil Cooler Tubes.** The tubes running to the oil cooler are provided with standard fittings that permit easy replacement of either line. When installing new lines, make sure that the new line has the same contour as the original contour of the line removed.

### **123. STEERING BRAKES.**

a. **General.** The use of the steering brakes is outlined in paragraph 5 b (6). When unusual noises are heard when the brakes are applied, the brake shoes must be examined and replaced if required to prevent scoring of the brake drums. When the free travel of the steering levers has increased to 8 inches, minor adjustment of the brakes is necessary. If this minor adjustment fails to establish good brakes, make the major brake adjustment (par. 123 d). If the major adjustment fails to establish good brakes, replace the brake shoes (par. 123 e).

3-INCH GUN MOTOR CARRIAGE M10A1



RA PD 36400

**Figure 76—Details of Brake Shoe and Brake Shaft**

b. **Check Steering Lever Free Travel.** With the vehicle stopped, measure the distance the top of each steering lever can be pulled back with the finger tips. Measure only the free travel that takes up the clearance between the brake shoes and the drum. If this free travel exceeds 8 inches, adjust the brakes (par. 123 c). When the vehicle is equipped with new brake linings, and the steering brake levers, linkage, and the steering brakes are in correct adjustment, each lever has a minimum free travel of approximately 4 inches. As brake linings wear, the free travel will increase.

c. **Steering Brake Adjustment (Minor).** Remove the brake adjustment port caps and gaskets (fig. 80). Insert wrench ( $1\frac{1}{8}$ -in. socket, extension, with ratchet handle) into the port (fig. 75) and take up brake adjusting nut (fig. 76), turning clockwise the necessary number of notches to adjust steering levers to a free travel of 4 inches. If a free travel of 4 inches cannot be obtained, make a major adjustment as outlined in paragraph 123 d. Remove the socket wrench. **NOTE:** Be careful that socket does not come off extension and drop into differential housing. Check the steering brake levers

## POWER TRAIN (TRANSMISSION, DIFFERENTIAL, AND FINAL DRIVE)

for equal travel. A notch or two on either or both of the brake adjusting nuts, in either direction, is permissible to effect equalization. **NOTE:** Do not change steering lever stops. Measure steering lever free travel at the top of the steering levers (par. 123 b). Replace brake adjustment port gaskets and caps and tighten securely.

### d. Steering Brake Adjustment (Major).

(1) **WHEN REQUIRED.** Major brake adjustments are necessary when new brake linings are installed, a minor brake adjustment (par. 123 c) fails to correct the trouble, the power train has been removed, or the steering brake lever linkage has been disconnected or changed.

#### (2) PROCEDURE.

(a) *Drain Power Train.* Drain oil from power train (par. 118 d) into clean containers, sufficient to hold 152 quarts. **NOTE:** If lubricating oil is to be used again, it must be filtered through clean cloth before it is poured back.

(b) **REMOVE STEERING BRAKE COVER PLATES** (fig. 80). Remove the cap screws from the right and left steering brake cover plates. Remove the plates and gaskets.

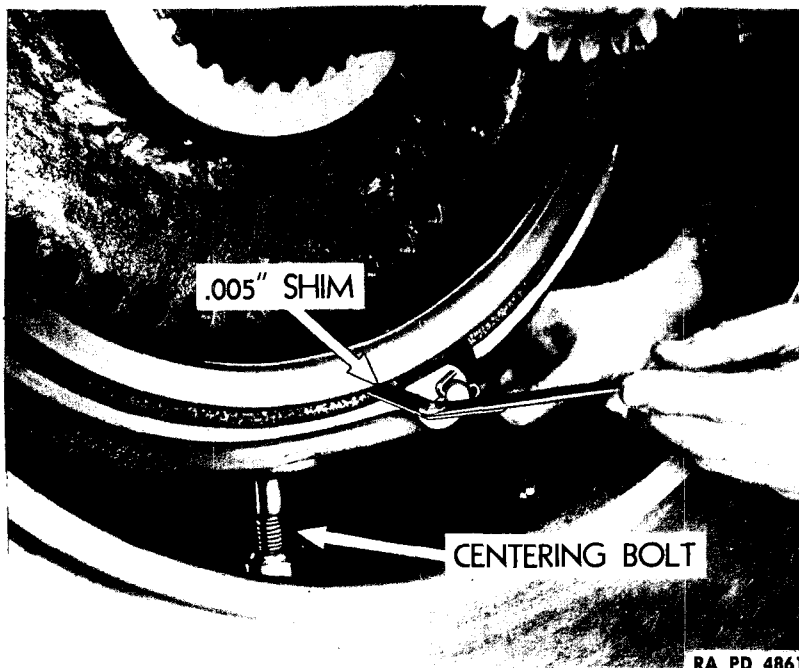
(3) **CHECK INDEX MARKS.** The right and left brake actuating levers (fig. 80), on the left side of the power train, and the actuating lever for the right-hand brake at the right side of the power train, are marked with a chisel at the time of original assembly. This mark on both the shaft and the lever permits reassembly of these parts in their original position. If these three levers do not have these index marks in line with the marks on their shaft, remove the levers and install them so that the marks do line up. If index marks are absent or indistinct, mark the shaft ends and lever hubs (before disassembling) to assure correct reassembling.

(4) **DISCONNECT STEERING LEVER LINKAGE.** Remove cotter pins and clevis pins from steering lever connecting rod's upper clevises (fig. 80) and disconnect the rods from the right and left brake actuating levers, both on the left side of the differential housing. Remove steering brake cover plates and gaskets (fig. 80).

(5) **ADJUST BRAKE SHOE CENTERING BOLT** (fig. 77). Back off the centering bolt jam nut and adjust the bolt to obtain a 0.005-inch clearance between brake drum and brake lining at a point directly over centering bolt (fig. 77). Tighten the jam nut, and recheck with a feeler gage.

(6) **ADJUST BRAKES TO POSITION ACTUATING LEVERS** (fig. 80). Tighten left brake adjusting nut (par. 123 c) all the way until the brake shoe is compressed against the drum; then, back off approximately 12 notches or until the end of left brake lever has  $\frac{3}{4}$ -inch free play up and down, measured at the end of the lever. Follow the same procedure for right brake lever.

3-INCH GUN MOTOR CARRIAGE M10A1



**Figure 77—Adjusting Centering Bolt**

(7) **ADJUST STEERING LEVER STOP SCREWS.** Loosen the lock nuts on the steering lever stop screws. Adjust the left steering lever stop screw so that rear edge of the left steering lever is opposite the clevis pin hole in the left brake actuating lever. Adjust the right steering lever stop screw so that the right steering lever is lined up with the left steering lever. Tighten both stop screw lock nuts.

(8) **ADJUST STEERING LEVER CONNECTING RODS.** With steering levers forward against their stops, adjust the clevises on the steering lever connecting rods (fig. 80) so that the clevis pin holes in the clevises are in line with the clevis pin holes in the brake shaft levers (levers to be pressed downward). Line up the lever clevis pin holes and connecting rod clevis pin holes, then unscrew the clevises three full turns to increase the length of the rods. Line up holes in actuating levers and connecting rod clevises. Install clevis pins and cotter pins. This additional length of each steering lever connecting rod will give the necessary clearance between the brake linings and the drums.

(9) **TEST STEERING LEVERS FOR EQUAL TRAVEL.** A notch or two on either or both of the steering brake adjusting nuts, in either direction, is permissible to effect equalization. An approximately correct adjustment will have been obtained when the brake shoes just engage

**POWER TRAIN (TRANSMISSION, DIFFERENTIAL, AND FINAL DRIVE)**

RA PD 4863

**Figure 78—Removing Link Pin from Cam**

the brake drums when the steering levers are pulled back to a nearly vertical position. Install both steering brake cover plates and gaskets. Make sure gaskets are in good condition. Refill power train with lubricating oil, following instructions in Lubrication Guide (par. 24).

**e. Replacement of Brake Shoes.**

(1) **REMOVAL.** Drain the power train unit (par. 118 d). Disconnect both steering lever connecting rod clevises at the left side of the differential housing. Remove the clevis pin from the lower yoke of the brake shaft actuating lever on the right side of the differential housing and disconnect the link. Remove the steering brake cover plates and gaskets (par. 123 d (2)) and wipe out the housing. Loosen the lock nut and turn down the centering bolt (fig. 77) (1-in. and



**3-INCH GUN MOTOR CARRIAGE M10A1**

$\frac{7}{8}$ -in. open-end wrenches) below the brake shoes as far as possible to provide clearance when removing the shoes.

(a) *Disconnect Brake Shoes* (fig. 76). The following procedure applies to both right- and left-hand brakes. Remove the brake adjusting nut (fig. 76) ( $1\frac{1}{8}$ -in. socket wrench). Remove the adjusting nut anchor washer from the brake adjusting rod. Push the end of the brake adjusting rod (fig. 76) through the brake shaft pin, and remove the washer and spring, taking care not to drop the washer inside housing. The end of brake shoe assembly toward front of the vehicle is now free, and the assembly will slide part way off the top of the brake drum to rest against the differential housing.

(b) *Remove Link Pin* (fig. 78). To provide clearance for removing the link pin, remove the cap screw nearest the inspection opening from the brake shaft trunnion on the outside of the differential housing. Move the brake shoe and brake linkage toward the outside of the housing. Remove the cotter pin from the link pin. Remove the pin through the hole in the housing from which the cap screw was removed.

(c) *Remove Brake Shoes* (fig. 79). Pull the brake shoe assembly around and from under the brake drum toward the inside of the vehicle. Use a pinch bar to aid in working the shoe assembly out. **CAUTION:** Use care in working the hinged section of brake shoe assembly over the centering bolt (fig. 77). Inspect all brake parts for wear and breakage, replacing them with new parts if necessary. Wipe out the housing and remove any foreign matter. Disassemble the brake shoes by removing the cotter pins and link pins (fig. 76). Inspect the pins and holes for wear. Inspect the lining for wear and loose rivets. Replace or reline shoes having worn linings.

(2) **INSTALLATION OF BRAKE SHOES IN HOUSINGS.** Reverse the sequence of the steps in the removal procedure except the following: Attach a wire to the end of the shoe to which the adjusting rod is attached (fig. 76). Start the wire and adjusting rod into the bottom of the housing opening, sliding the shoe around the drum until wire can be reached from the upper part of the housing opening. Pull the shoe assembly around the drum and into place at the upper part of the housing. Remove the wire. Adjust the brake shoes as outlined in paragraph 123 d.

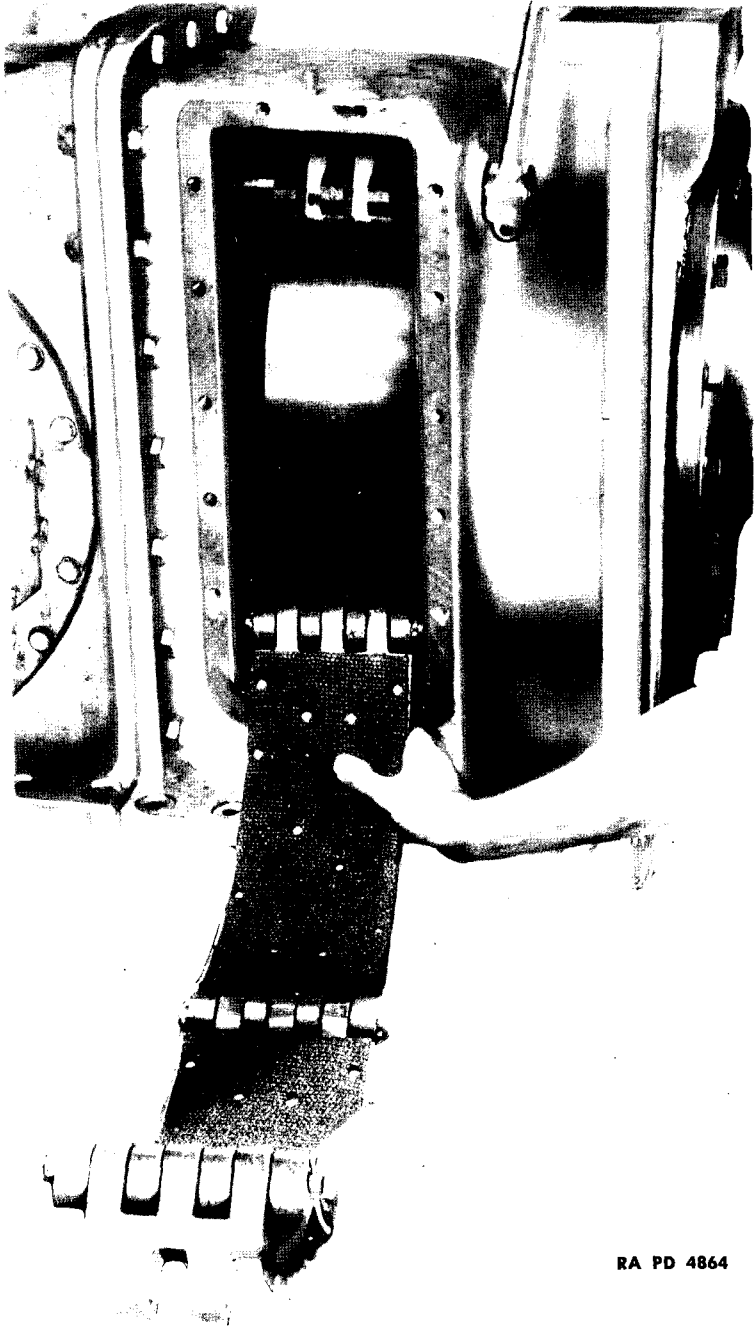
**124. PARKING BRAKE** (fig. 80).

a. **Description.** A description and the use and operation of the earlier and the later type parking brake is covered in paragraph 5 b (7) (2).

b. **Replacement.**

(1) **REMOVAL OF EARLIER TYPE BRAKE.** Remove the cap screws from the forward universal joint cover and remove the cover. Remove

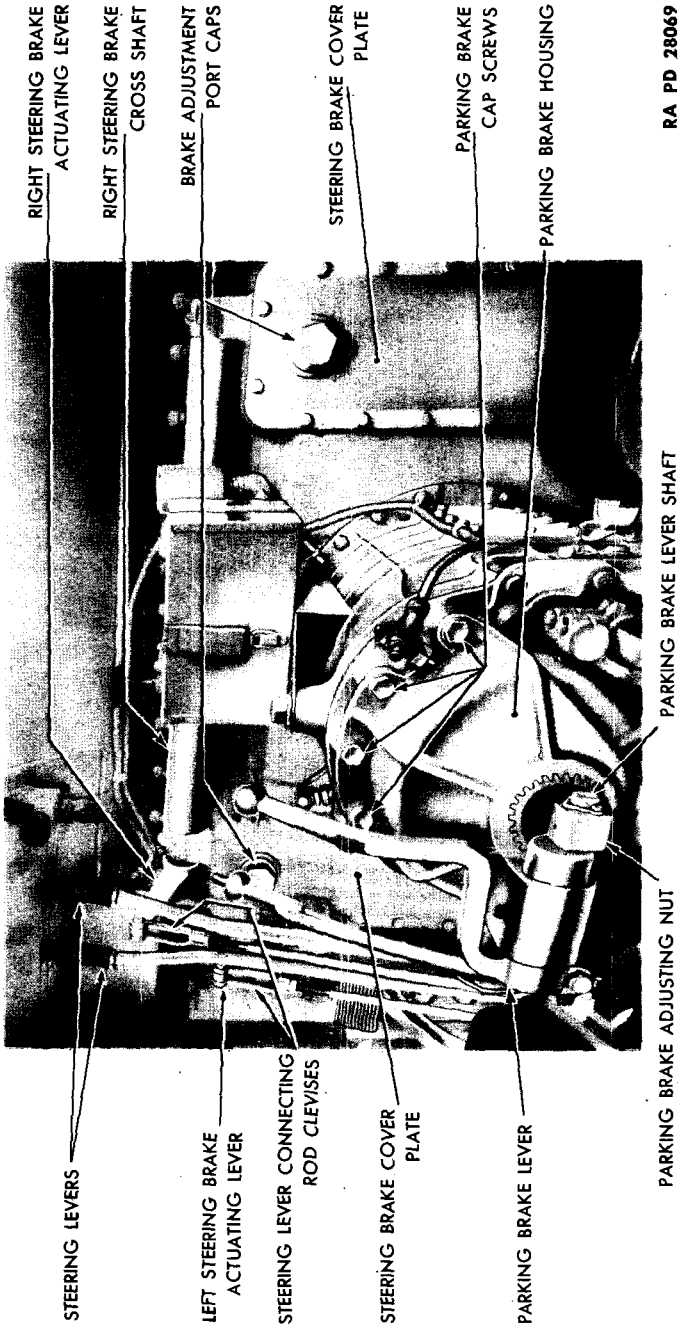
**POWER TRAIN (TRANSMISSION, DIFFERENTIAL, AND FINAL DRIVE)**



RA PD 4864

**Figure 79—Pulling Brake Shoe Out of Housing**

3-INCH GUN MOTOR CARRIAGE M10A1



RA PD 28069

Figure 80—Steering Brake Housing and Linkage

**POWER TRAIN (TRANSMISSION, DIFFERENTIAL, AND FINAL DRIVE)**

the cotter pin and washer from the parking brake lever shaft and remove the shaft and lever (fig. 80). Remove the cap screws which hold the parking brake housing to the transmission. Pull the housing off the brake shoe spline and remove the housing. Remove the brake shoe cone.

(2) **INSTALLATION.** Reverse the sequence of the steps in the removal procedure, but, select a position on the spline where the brake shaft spacer will mesh into the recess in the spline, when installing the housing over the brake shoe spline.

(3) **REMOVAL OF LATER TYPE PARKING BRAKE MECHANISM** (fig. 8). Push the quadrant pedal all the way down. Remove the lock wire and the cap screws which hold the quadrant assembly (fig. 8) to the floor. Remove the quadrants. To reinstall, reverse the sequence of the steps in the removal procedure.

c. **Adjustment of Earlier Type Brake** (fig. 80). Remove the parking brake lever with the brake shaft lever attached, by withdrawing the cotter pin from the shaft. Slide the shaft out of the adjusting nut of the toggle link and remove the washer and spacer. Screw the adjusting nut outward (counterclockwise), to lengthen the link and decrease the clearance between the brake lining and the drum. The adjusting nut must be given a complete turn, or several complete turns, in order to bring the oil hole on top. Reinstall the brake shaft, spacer, washer, and cotter pin, and test adjustment. Readjust as necessary to effect complete contact between the shoe and the drum when the lever is in the locked position. When the proper adjustment has been attained, lock the brake by pulling the lever all the way back, then loosen the clamping bolt at the bottom of the brake lever, move the lever to vertical or slightly forward position, and tighten the clamping bolt. Secure the nut on the bolt with a cotter pin.

3-INCH GUN MOTOR CARRIAGE M10A1

Section XIX

SUSPENSION AND TRACKS

	Paragraph
General description .....	125
Inspections .....	126
Drive sprockets .....	127
Bogies .....	128
Tracks .....	129
Idlers .....	130
Installation of grousers .....	131

**125. GENERAL DESCRIPTION.**

a. Six two-wheeled rubber-tired bogies, or suspensions, bolted to the hull, support the vehicle on volute springs. The tracks are driven by sprockets at the front of the vehicle. Two idlers are mounted on eccentric shafts at the rear end of the hull. These shafts are made eccentric to provide for the adjustment of track tension. The weight of the upper part of the track, between the idler and the sprocket, is carried by three steel track support rollers mounted on brackets attached to the bogie brackets.

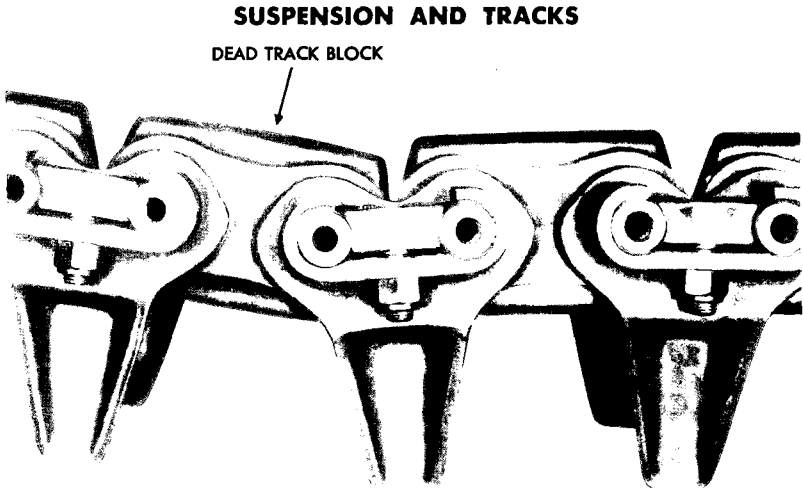
**126. INSPECTIONS.**

a. **General Instructions.** Tracks and suspensions should be inspected at every opportunity in order to detect in the early stages any fault that, if not corrected, would lead to serious impairment of the efficiency of the vehicle. The best preventive maintenance is to keep the entire track and suspension system as clean as possible, and free from stones, sticks, and other solid debris. At every inspection, the following routine must be carried out.

**b. Procedure.**

(1) **TRACK TENSION.** If the track shows a noticeable sag between the track support rollers, the track should be adjusted (par. 129 b).

(2) **TRACK CONDITION.** Check the end connectors for wear and bent or broken guide lugs. Inspect all wedges and nuts for presence and tightness. Check for bottomed wedges; if the clearance between the wedge and connector is less than one thirty-second inch, install a new wedge. If grousers are being used, inspect their condition and tightness. Inspect for dead track blocks (fig. 81) and replace them (par. 129 c). A dead track block must be in the top section of the track to be detected, so the vehicle must be moved several times to



RA PD 12481

**Figure 81—Dead Track Block Dropping Out of Line on Top of Track**

make a complete inspection. During this check, the inside wedge and connectors must also be inspected.

(3) **SPROCKETS.** Check for sprung or worn teeth. Check cap screws and hub nuts for tightness.

(4) **BOGIE WHEELS.** Check the condition of the tires on all wheels. Look for evidence of the outer spacer turning (tighten gudgeon nut). Check gudgeon nuts and cotter pins for presence. Check grease fittings and relief valves (replace if damaged or missing).

(5) **BOGIE ASSEMBLIES.** Check for broken or weak volute springs. Inspect for worn wheel arm and lever rubbing plates (fig. 82). Inspect bogie bracket for presence of bolts, nuts, and lock wire.

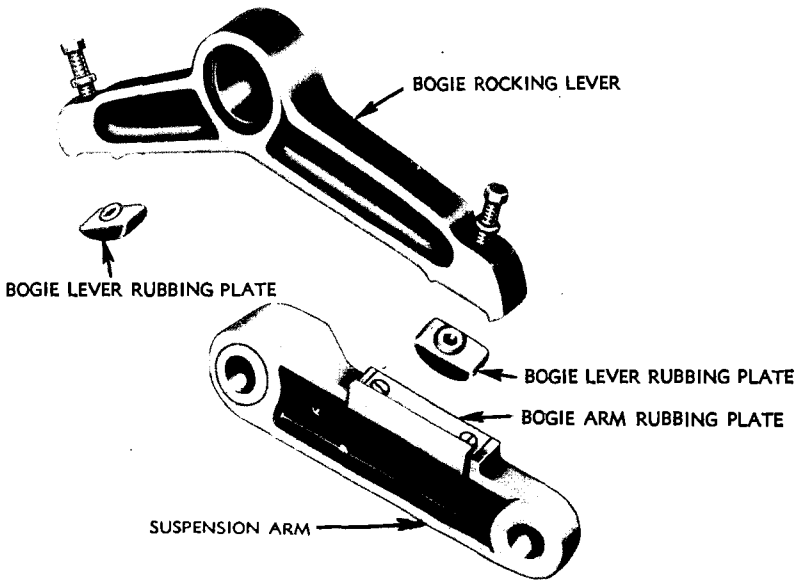
(6) **SUPPORT ROLLERS.** Look for evidence of rollers not turning. Free all rollers by cleaning out mud, rocks, etc. Check grease fittings (it is essential that all rollers turn freely, since inoperative rollers will develop flats).

(7) **IDLERS.** Check idler cap retaining screws and grease fittings (fig. 91).

## 127. DRIVE SPROCKETS.

a. **Description** (fig. 83). The sprocket and hub assembly is formed by bolting two sprockets to a hub, which is attached by studs and nuts to the drive flange of the final drive shaft. Sprocket and hub assemblies, interchangeable as units, should be transposed between the right and left final drive shafts when the sprocket teeth have become appreciably worn on their flanks from long use in one direction.

3-INCH GUN MOTOR CARRIAGE M10A1



RA PD 65938

**Figure 82—Bogie Arm and Lever**

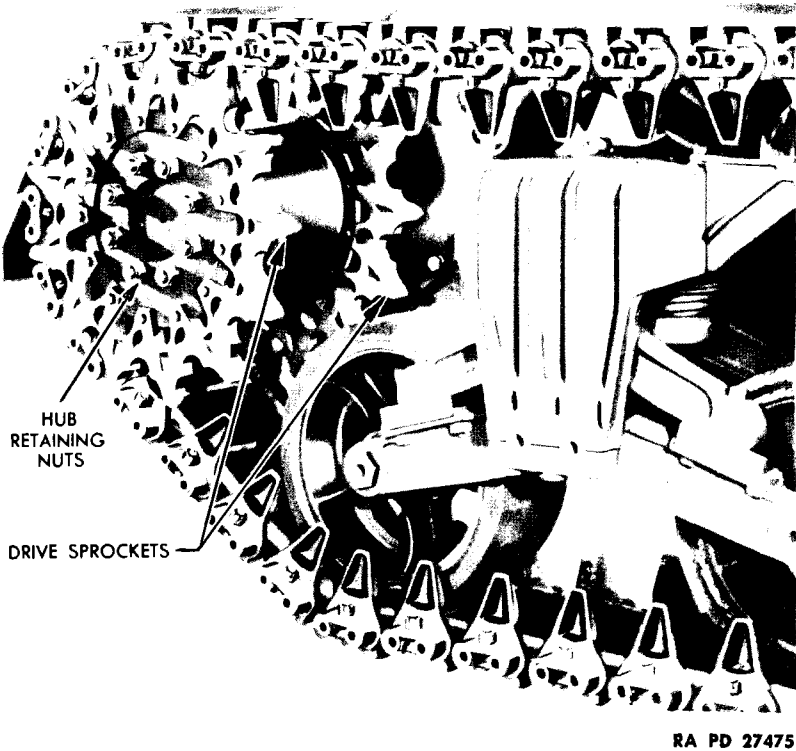
**b. Sprocket and Hub Assembly Replacement (fig. 83).** To remove the sprocket and hub assembly, slacken the track (par. 129 b). Disconnect the track below the sprocket (par. 129 d). Remove the eight hub retaining nuts. Remove the hub assembly. To reinstall, reverse the sequence of the steps in the removal procedure.

**128. BOGIES.**

**a. Description.** The six bogies are the vehicle supporting units, sometimes called suspensions. Vertical movement of the wheels, as they pass over irregularities in the ground surface, is transferred to the supporting arms and levers, and is absorbed by volute springs, two in each bogie. Wear between the wheel arms and the spring levers is taken by upper and lower rubbing plates (fig. 82), which can be replaced when worn. On the rear side of each bogie bracket is mounted a single steel roller to support and guide the track between the idler and the sprocket. Whenever bogie wheels are changed, retainer (seal) B132704AB and spacer (adapter) B153965 will be installed when available (par. 128 d).

**b. Lubrication.** Lubrication of the wheels and the track-supporting rollers is through pressure gun fittings. Relief valves are provided to prevent damage to the grease retainers (sec. VI).

## SUSPENSION AND TRACKS



RA PD 27475

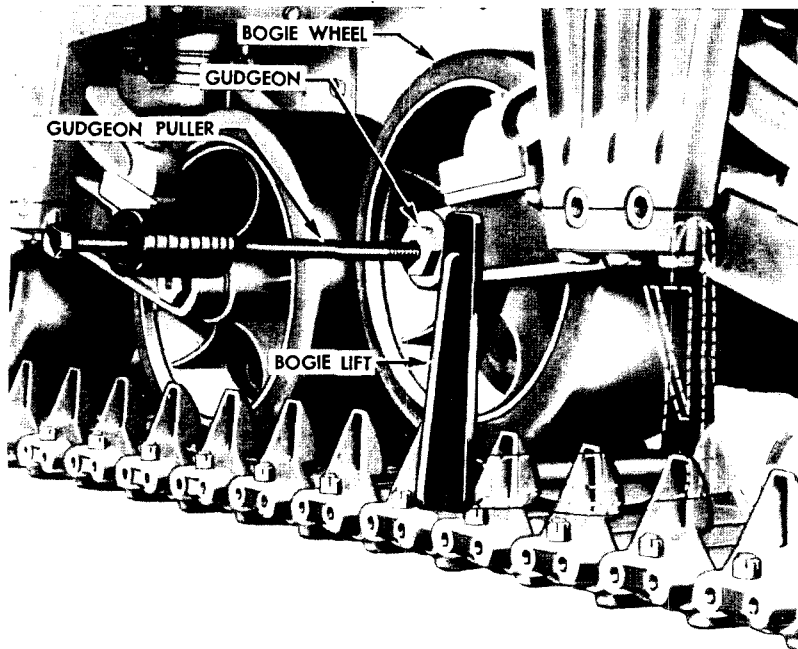
**Figure 83—Sprocket and Hub Assembly**

### c. Bogie Wheel Replacement.

(1) **REMOVAL.** To remove bogie wheel, raise the wheel by means of one of the following two methods: Place the bogie wheel lift (41-D-1463) (fig. 84) on the track under the suspension arms to be lifted. Carefully drive the vehicle forward or backward (depending on which bogie wheel is to be lifted) until the bogie lift is vertical and the bogie wheel has been lifted, or place two 5-ton hydraulic jacks on the track directly under the center of each end of the spring seat plate, and jack up the spring seat until all load is removed from the wheel arms (fig. 85). Remove the cotter pin from the nut on the inner end of the wheel gudgeon and remove the gudgeon nut ( $2\frac{3}{8}$ -in. gudgeon wrench). Remove the gudgeon pin. Two types of gudgeon pins have been used and are removed as follows: Gudgeon pins having a threaded hole on the outer end can be pulled by screwing the slide hammer bogie gudgeon puller (41-P-2957-33) (fig. 84) into the threaded hole and pull the gudgeon. To remove the gudgeon pin with no hole provided for the puller, drive on the inner end of pin with drift. Remove the wheel from between the arms.



## 3-INCH GUN MOTOR CARRIAGE M10A1



RA PD 65939

**Figure 84—Pulling Wheel Gudgeon to Remove Bogie Wheel**

(2) **INSTALLATION.** Move the wheel into place between the two arms. Raise the arms and align their holes with the hole in the wheel. Start the wheel gudgeon through the outer arm and into the outer spacer, grease seals, and outer bearing of the wheel. Line up the center spacer by means of an alignment bar inserted from the inner side of the wheel, and tap the gudgeon into the spacer. Then drive the gudgeon through far enough to allow the key slot in the gudgeon to be lined up with the slot in the arm. Install the key, and drive the gudgeon in the rest of the way. Install and tighten the gudgeon nut on the inner end of the gudgeon and secure with a cotter pin.

**d. Bogie Wheel Grease Seal and Bearing Replacement.**

(1) **REMOVAL.** Remove bogie wheel (par. 128 c). Pull out the two outer spacers. Turn the wheel on its side on blocks and, with a brass drift (41-D-1463) through the upper side of the wheel, drive the bearing and grease seals out of the lower side. (It will be necessary to move the inner spacer away from the bearing in order to seat the drift on the outer race of the bearings. Keep moving the drift around the entire circumference of the bearing outer race, in order to drive it out evenly and with no damage to the bearings.) The spacer will drop out when the bearing is removed. Turn the wheel over and remove the

## SUSPENSION AND TRACKS

other bearing and grease seals by the same method. Clean the bearings and inspect for wear, cracked rollers, or flat spots.

(2) **INSTALLATION.** When the bogie wheel grease seal and bearing are being replaced, be certain to install the new type retainer (seal) B132704AB and spacer (adapter) B153965. Do not reinstall seal A244899, spacer B197500, and backing plate B197501, as they are obsolete upon the availability of the new seal and spacer listed above.

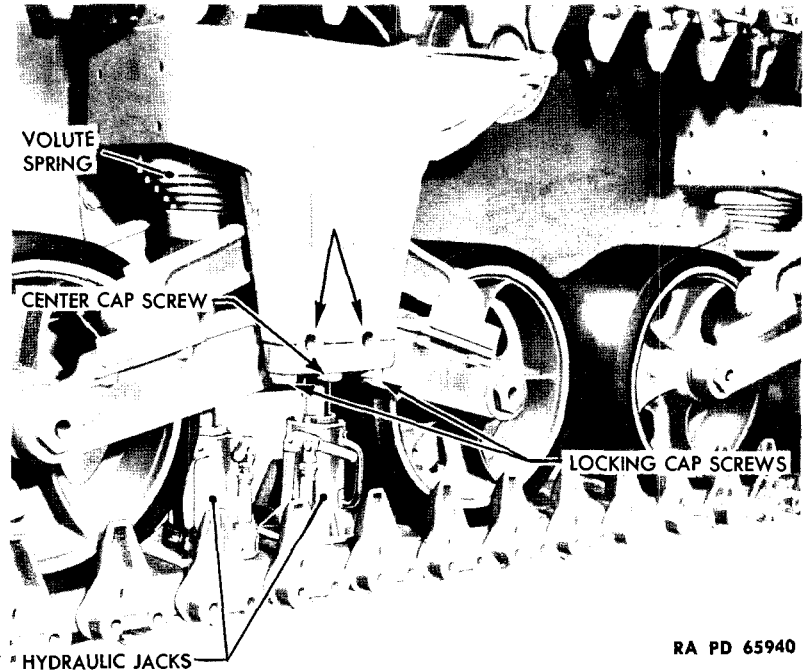
(a) Install the bearing by starting it by hand and tapping it lightly into place with a brass drift (41-D-1463), working around the outer race. Be sure the bearing is squarely seated against the shoulder in the wheel, to allow room for the grease seals. End play of bogie wheels equipped with tapered roller bearings should be checked whenever rawhide seals are installed; play should be from 0.003 to 0.021 inch. If end play of tapered roller bearings exceeds 0.021 inch, or in case of bearing failure, tapered roller bearings will be replaced with ball bearings CABX3AL when available.

(b) A rawhide type seal should be soaked thoroughly for 30 minutes with engine oil, or neat's-foot oil, before installation. Seals must be kept in waterproof wrappers, away from moisture, extreme heat, or cold. Sand or dirt must not be allowed to get on the seal to serve as an abrasive. Coat the sealing surfaces well with grease before assembly, and place a liberal supply of grease between the retainers. Use the proper drift or a rawhide hammer to carefully seat the seal. Be sure the seal is placed squarely in the opening and not cocked or bent. When a seal is bent or twisted during installation, it must be discarded and another new one used. The sealing lips of the seal must be pointing to the outside of the bogie wheel, to realize the primary purpose of preventing entry of dust and mud into the bearing assembly. After installing outer spacer and seals, turn the wheel over and install center spacer, bearing, oil seals, and spacer as described above. If the sealing surface of the spacer is etched, nicked, rough, or untrue, a new part should be installed to insure a smooth sealing surface.

### e. Volute Spring Replacement (fig. 85).

(1) **REMOVAL.** Place two 5-ton jacks beneath springs. Position the jacks on the track so that the head of each jack is in the center of each end of the spring seat plate. In placing the jack, arrange the blocking so that the jack plunger will be nearly at the upper end of its travel when the thrust of the springs is taken up, in order to permit a greater lowering travel later (fig. 85). Jack up seat plate. Raise each jack until the thrust of the springs has been taken up. Straighten the ears of locking plate, remove the two locking cap screws, and loosen the center cap screw that secures the center gudgeon pins in the bogie bracket (fig. 85). Remove the bogie gudgeon pins (par. 128 c (1)). When the pins are pulled out, the bogie arms and gudgeon spacers will drop.

3-INCH GUN MOTOR CARRIAGE M10A1



RA PD 65940

**Figure 85—Changing Volute Springs**

Lower the jack with the spring seat plate and springs. If the jack has not sufficient travel to decompress the springs, push two bars through the gudgeon pin holes, and lower the spring seat plate on to the bars. Remove the blocking, or lower the adjustable screw on the jack, and again raise the plate off the bars with the jack. Remove the bars, and continue to lower the jack and decompress the spring. If the spring seat plate and springs do not drop out on removal of the jack, free them with a hammer or wood block. **NOTE:** Whenever a new volute spring is required, install two new springs, never one old and one new spring.

(2) **INSTALLATION.** Place the springs and spring seat plate in position and raise with the jacks until the springs are compressed sufficiently. Aline the bogie arms and spacer plates and install the gudgeon pins, making sure that their grooves are on the side to permit installation of the locking cap screws. Install the gudgeon locking cap screws and secure the lock plate to the cap screw heads. Lower and remove the jacks, allowing the bogie levers to resume their normal position on the wheel arms.

f. **Track Support Roller and Bracket Replacement.** To remove

## SUSPENSION AND TRACKS

the track support roller and bracket, remove the lock wires and the four cap screws securing the track skid to the top of the bogie frame, place a jack between the front bogie wheel and track, and raise track to remove its weight from the bogie wheel. Remove the track skid. Remove the lock wire and the six cap screws holding the roller bracket to the bogie frame and remove roller and bracket assembly. Remove the lock wires and the four cap screws securing the roller shaft to the bracket and lift roller and bracket. To reinstall, reverse the sequence of the steps in the removal procedure.

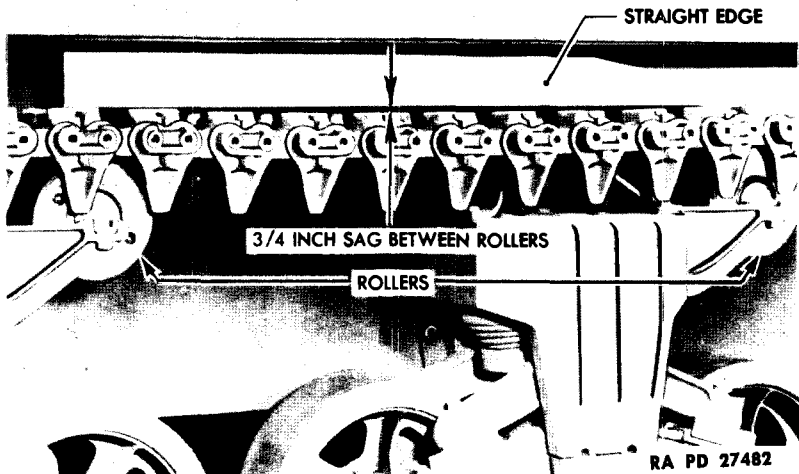
### 129. TRACKS.

#### a. Description.

(1) **GENERAL.** Each track has 79 separate shoes, or blocks, which may be rubber-covered, or all steel. Two parallel pins run through each block, and project at both ends. Steel connectors fit over the ends of the adjacent pins of adjoining blocks, linking the blocks on both sides to form a continuous track. Each track pin has doughnut-shaped rubber spacers vulcanized to fit. These spacers, when the pin is pressed into the steel frame of the track block, form a flexible cushioning bond between the pin and the block. The connectors are held on the pins by wedges, which fit against milled flats on the pins. These flats face outward, and are inclined at an angle of 7 degrees to the tread surface of the block. The wedges are tapered at 15-degree angles on each face, so that when they are pulled up between the two pins by the bolt (an integral part of the wedge), they cause a 16-degree angle between adjacent blocks. This angularity tends to make the track curve around the rear bogie, the idler, and the sprocket. Flared perpendicular projections on the end plates serve as guides to keep the track in alignment and to hold it on the bogie wheels, idlers, track support rollers, and drive sprockets. The sprocket teeth engage the track between adjacent connectors. Since the condition and effectiveness of the track can definitely limit or increase the performance ability of the vehicle, it is essential that it is inspected, adjusted, and maintained in the best possible condition. Several types of track block are used (par. 129 a (2), and (3)).

(2) **RUBBER BLOCK TYPE.** Two designs of rubber blocks are in use, the first having the same thickness of rubber on both sides, the second having a greater thickness of rubber on the tread (ground contact side) than on the bogie wheel contact side. Shoes of the last type must be replaced when further wearing away of the tread would expose the tubular sections of the inner steel link to the risk of being dented or deformed. Damaged shoes must be replaced immediately. Shoes of the first type (same thickness on both tread and bogie side), whose tread rubber has worn thinner than the rubber on the inner side may be reversed (par. 129 d). This type of shoe will be replaced when the rubber on the second side has worn to the extent that wear in the steel links is imminent.

## 3-INCH GUN MOTOR CARRIAGE M10A1



**Figure 86—Checking Track Tension**

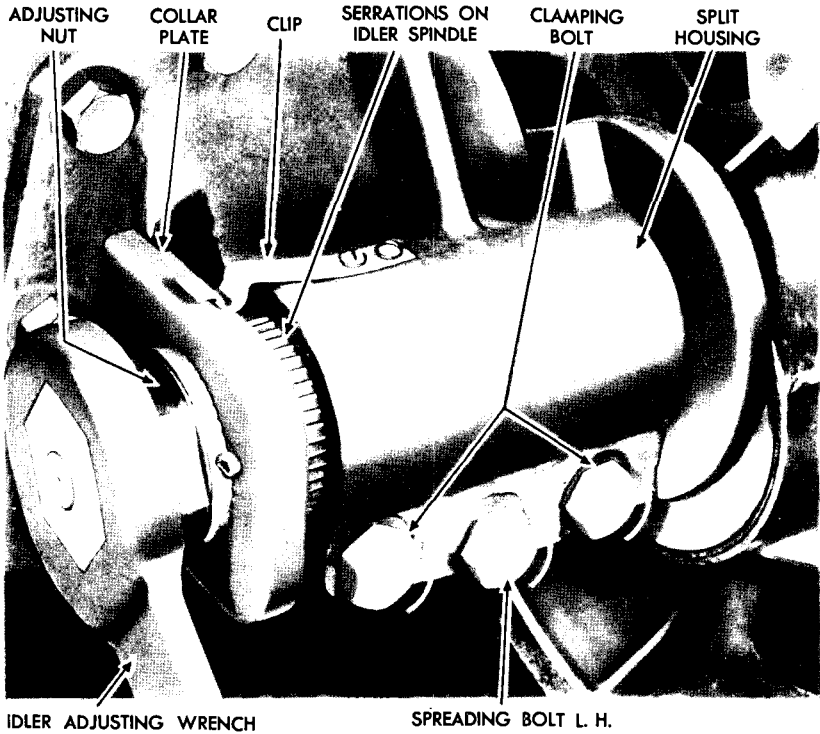
(3) **ALL-STEEL TYPE.** Steel shoes are formed with one long lug at the toe of the block (the forward edge when the block is on the ground) and two short lugs at the heel (rear edge). Tracks will normally be installed, when new, with the long lugs forward when the shoes are on the ground; but the entire track may be turned end-for-end when it is necessary (par. 129 g).

**b. Track Tension Adjustment (fig. 86).**

(1) **METHOD.** The track should be checked daily for correct tension. If a pronounced sag is present, tension should be restored to eliminate the possibility of the tracks being damaged or thrown off. Figure 86 shows the correct track adjustment. Track tension is adjusted by turning the spindle of the eccentric idler shaft (fig. 87).

(2) **SETTING THE ADJUSTMENT.** Partially back out (do not remove) the two end (clamping) bolts of the three bolts on the rear of the split housing (fig. 87). Turn down the spreading bolt to open up the housing. **NOTE:** Because this bolt has a left-hand thread, it also is turned counterclockwise to spread the split housing. In loosening or tightening the spindle, the spreader bolt is turned in the same direction as the clamping bolts. Raise the spring clip at the end of the housing, loosening its screw if necessary, and tap the collar plate all the way off the serrations on the spindle to the position shown in figure 87. It may be necessary to take the load off the collar by using the idler adjusting wrench on the hexagon end of the spindle, as in tightening the track. Tighten or loosen the track by using the idler adjusting wrench (41-W-640-400) on the hexagon at the end of the spindle. To tighten, raise the handle of the wrench (using a pipe for

**SUSPENSION AND TRACKS**



RA PD 36420

**Figure 87—Tightening Track with Idler Adjustment**

leverage, or a jack under the end of the handle) until the track shows a sag of not more than  $\frac{3}{4}$  inch midway between the support rollers. Sag can be measured from a straight edge placed on the track between the support rollers (fig. 86). **CAUTION:** Tracks that are too tight will cause a serious reduction in the performance of the vehicle.

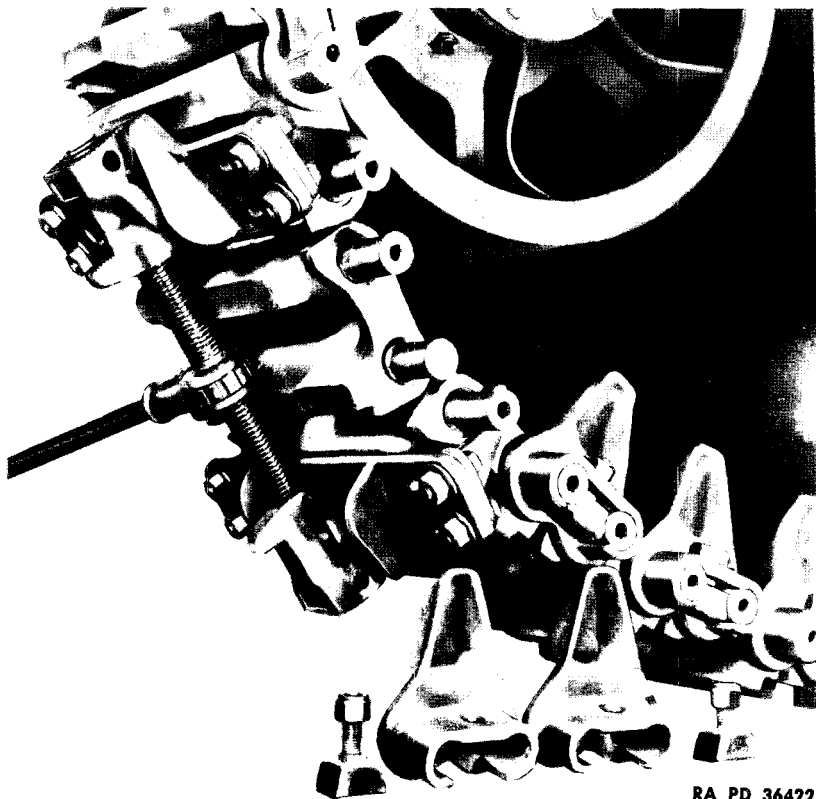
(3) **LOCKING THE ADJUSTMENT.** Drive the collar plate back on the serrations of the spindle and lock it in place with the spring clip. Back out the center spreader bolt by turning it clockwise. (Make sure that it does not project into the split of the housing.) Pull both outside clamping bolts up tight, and tighten down the spreader bolt until it binds sufficiently to hold it from working loose.

**c. Dead Track Block Replacement (fig. 88).**

(1) **DEFINITION.** A dead track block is one in which the rubber bond between the pin and the metal frame of the block has failed, leaving the pin free to turn. Dead blocks are easily recognizable (fig. 81) and should be replaced immediately as they may result in a broken track.

(2) **REMOVAL.** Move the vehicle so that block to be replaced is

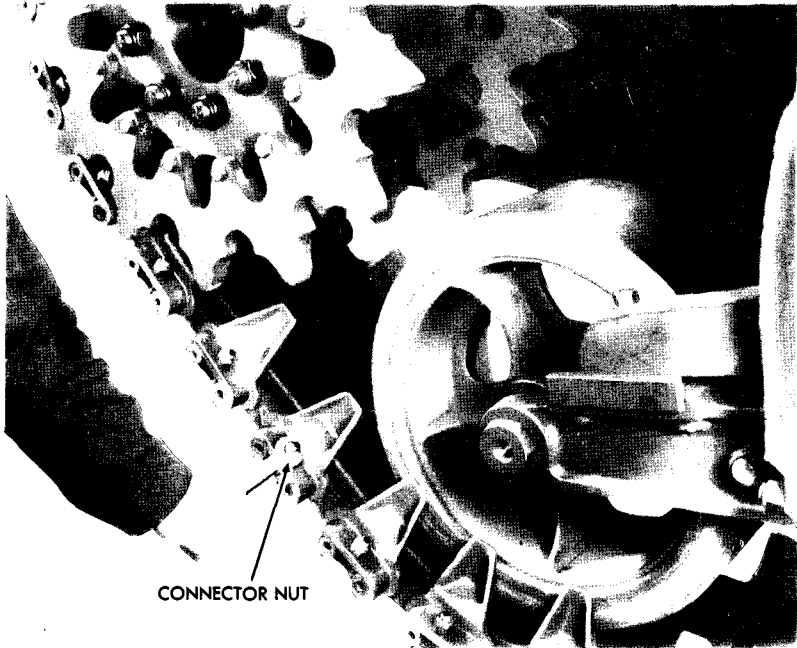
3-INCH GUN MOTOR CARRIAGE M10A1



**Figure 88—Replacing Dead Track Block**

midway between the idler and the rear bogie wheel. Set the parking brake. Release the track tension (par. 129 h). Remove the wedge nuts on the two inside and two outside connections (fig. 89) attached to the block to be replaced. Tap out the wedges, being careful not to injure threads. Drive the two inside and two outside track connectors halfway off the pins of the track block to be removed. Between the track connectors and the blocks, insert the curved fingers of the Simplex jack track connecting fixture (41-F-2997-85 or 86) over the exposed pins in the two track blocks immediately adjacent to the dead track block (fig. 88). The upper surfaces of the track connecting fixture plates must fit snugly against the tread surfaces of the track blocks. Insert the handle in jack ratchet fitting. Pull up the track until the fixture is securely solid, then knock off the four loosened connectors. Figure 88 shows dead track block with outside track connectors removed, and inside connectors still in place, and the holding block.

SUSPENSION AND TRACKS



RA PD 12480

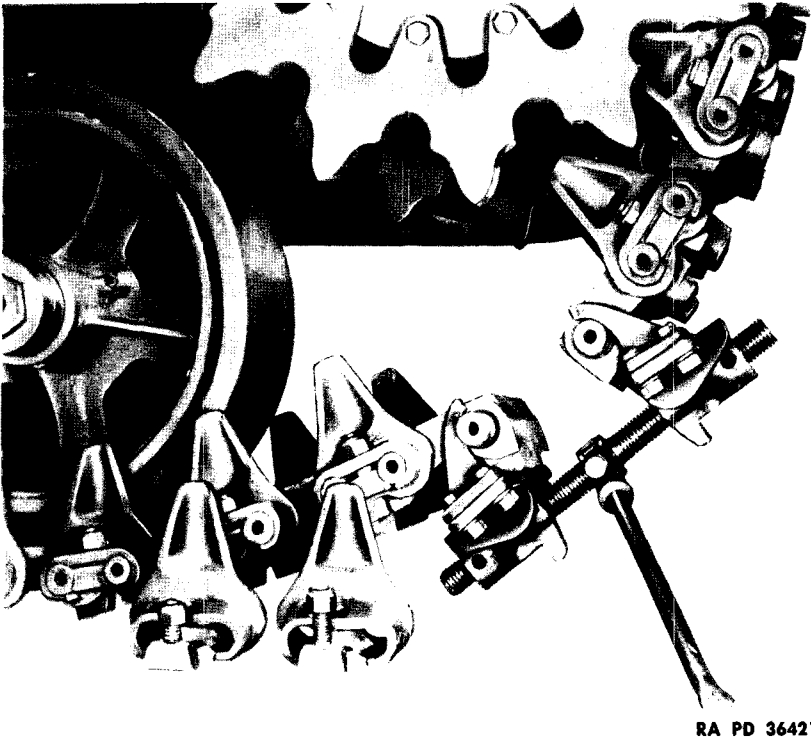
**Figure 89—Removing Track Wedge Nut**

(3) **INSTALLATION.** Place the new track block in position. Install the track connectors driving them halfway on to pins, operating the jack if necessary to position the pins. Back off the jack and remove the track connecting fixture. Drive connectors the rest of the way on. Install the wedges in connectors drawing them tight. **NOTE:** Before installing, inspect wedges and nuts, and replace if worn or damaged.

**d. Turning the Track Block.** When rubber track blocks are to be reversed (turned over) or several blocks must be replaced, the track should be removed from the vehicle. Note that the track is broken at the front of the tank, between the sprocket and the front bogie wheel, instead of at the rear, as for the replacement of a single block. Break the track just below the sprocket. Move the upper part of the track to the rear over the drive sprocket by turning the sprocket with a bar, and pull the track back off the rollers. Again break the track this time just in back of the rear bogie. Reverse the blocks of the part of the track just removed by removing all the connectors and turning each block over. To equalize the wear on the connectors, turn them end-for-end and install them on the opposite side of the track. Connect this reversed section of the track to the section underneath the bogie



## 3-INCH GUN MOTOR CARRIAGE M10A1



RA PD 36421

**Figure 90—Joining Ends of Track at Front Sprocket**

wheels and tow the vehicle back onto the section already reversed. Disconnect the remaining section of the track and reverse the blocks and connectors. Again connect the two sections of the track. Tow the vehicle onto the front section, and roll the rear section over the idler, support rollers, and sprocket, using a bar to turn the sprocket (par. 129 g). Connect the two ends of the track (fig. 88).

**e. Thrown Track Replacement.** Because conditions under which a track may be thrown vary greatly, no one procedure can be set down as the best possible method for its replacement. The following procedure can be used under the worst conditions, and can be modified for different situations. Break the track underneath either the idler or the sprocket, depending on which end of the track has the least twist. Tow the vehicle completely off the track. Roll up the track and move it to the front or to the rear of the vehicle, depending on which has the best ground for towing the vehicle back onto the track. Lay the track out with the end at the nearest bogie, with several blocks sunk in a trench dug deep enough so that the bogie can roll onto the track without having to climb. Tow the vehicle on to the track until

## SUSPENSION AND TRACKS

the leading bogie wheel is about 16 inches from the end of the track. Roll the track up over the idler and support roller, and around the sprocket, using a bar to turn the sprocket. **NOTE:** Sometimes the track may be thrown in such a manner that the proper manipulation of the vehicle, and the use of blocks, make it possible to work the track back on again.

### f. Track Replacement.

(1) **REMOVAL.** To install a new track when the old track is still on the vehicle, break the old track under the sprocket and roll the track back off the sprocket and rollers, using a bar to turn the sprocket. Lay out the track in front of the old one and connect the two. Tow the vehicle onto the new track until the front bogie wheel is about 16 inches from the end of the track. Disconnect the old track, and roll the new one up over the idlers, the track support rollers and around sprocket, and connect the ends (fig. 90).

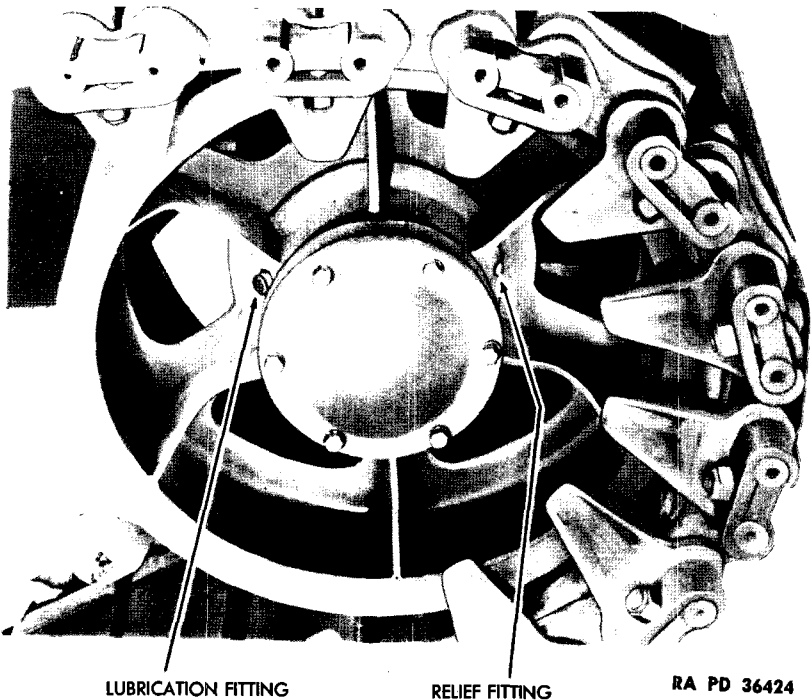
(2) **INSTALLATION.** To install a new track when the old track is off the vehicle, proceed as in paragraph 129 e.

### g. Reversing Track Direction.

(1) **GENERAL INSTRUCTIONS.** To equalize the driving wear on the track connectors, and thus lengthen the operating life of the track, the entire track can be turned end-for-end, shifting the driving wear to the other contact surfaces of the connectors. With good ground conditions, the shift can best be made by breaking the tracks at the front, just below the sprocket, working the tracks up and off the sprockets, and pulling the vehicle completely off both tracks. The following method can be used, when, because of mud, soft ground, or other conditions, it is advantageous to keep the vehicle on part of the track at all times and to move the vehicle under its own power.

(2) **PROCEDURE.** Break the right track at the rear, just below the idler, and using the left track for traction, move the vehicle ahead until the end of the right track comes off the sprocket. Break the right track at the middle, turn the free section around end-for-end, and drive the connectors on enough to hold the ends together. Move the vehicle back until the bogie wheels are on the reversed section of the track; then, reverse the other half of the track and reconnect the track, this time driving the connectors completely on and pulling down the wedges. Move the vehicle forward until the front bogie wheel is on the fourth tread block from the end. Attach the towing cable, by means of a chain, to the other end of the track, bringing the free end of the cable up over the idler and support rollers and around the hub of the sprocket. Insert a short bar through the sprocket and the towing eye of the cable and, using the sprocket hub as a windlass, pull the track forward to the sprocket with the engine power of the vehicle. **NOTE:** Both steering levers should be left free during this operation. Remove the cable from sprocket drum and work the track over the sprocket.

3-INCH GUN MOTOR CARRIAGE M10A1



**Figure 91—Details of Idler**

Connect the track (par. 129 c). Repeat the above operations for the left track.

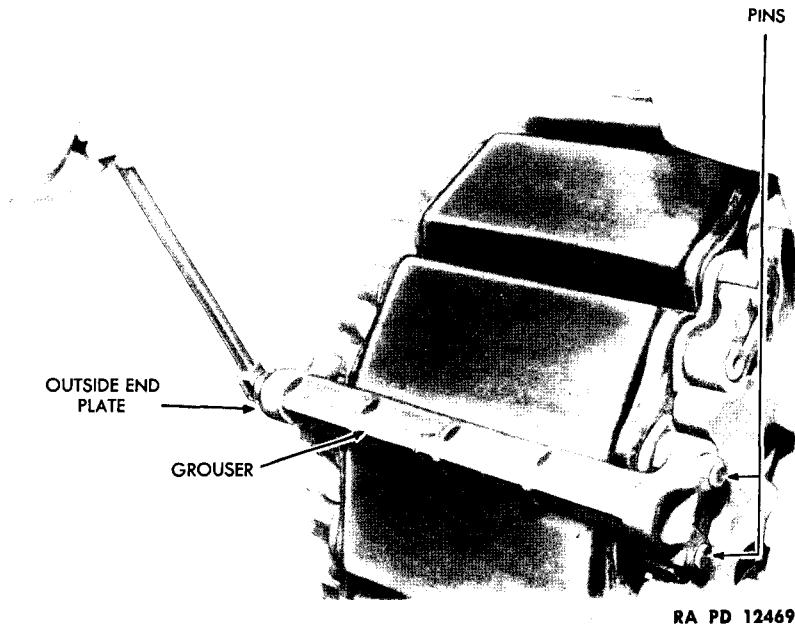
**130. IDLERS.**

a. **Description** (fig. 91). Two large steel idler wheels are mounted at the rear of the vehicle to guide and support the tracks. They are provided with a means of adjusting the tension of the tracks (par. 129 b).

b. **Lubrication** (sec. VI). A lubrication fitting adaptable to the grease gun is installed in the hub of the idler, which is also equipped with a relief fitting (fig. 91).

c. **Idler Wheel Replacement (With Track Removed)**. To remove the idler wheels, remove the idler cap by removing six cap screws. Take out the split pin securing the wheel nut and remove the nut. Remove the wheel. Before installing the wheel, clean the bearings, the grease retainers, and the spacer. Pack inner and outer bearings with grease and install the wheel. Install the wheel nut and the split pin. Install the idler cap and the six cap screws.

## SUSPENSION AND TRACKS



**Figure 92—Installing Grousers**

**d. Idler Bracket Replacement.** To remove the idler bracket, remove the idler wheel as outlined above, and remove 14 cap screws which secure the bracket to the hull. To reinstall, reverse the sequence of the removal procedure, except coat the surface of bracket which bears against the hull with sealer before installing.

### 131. INSTALLATION OF GROUSERS.

**a.** Grousers are for use only with rubber block tracks, to give positive traction on wet mud, ice, snow, and other slippery surfaces. There are 10 grousers and 3 spares for each track. In use, one grouser is installed on every eighth block of each track. To install, place the grouser across the track over the opening between 2 track blocks, and slide the 2 pins on the inside end of the grouser into the holes in the pins of the 2 blocks (fig. 92). Install the pins on the outside grouser end plate in the block pins and fasten the plate to the grouser with the special bolt and lock washer.

3-INCH GUN MOTOR CARRIAGE M10A1

Section XX

HULL AND TURRET

	Paragraph
Hull .....	132
Turret .....	133
Escape hatch .....	134
Vision and sighting equipment .....	135

132. HULL.

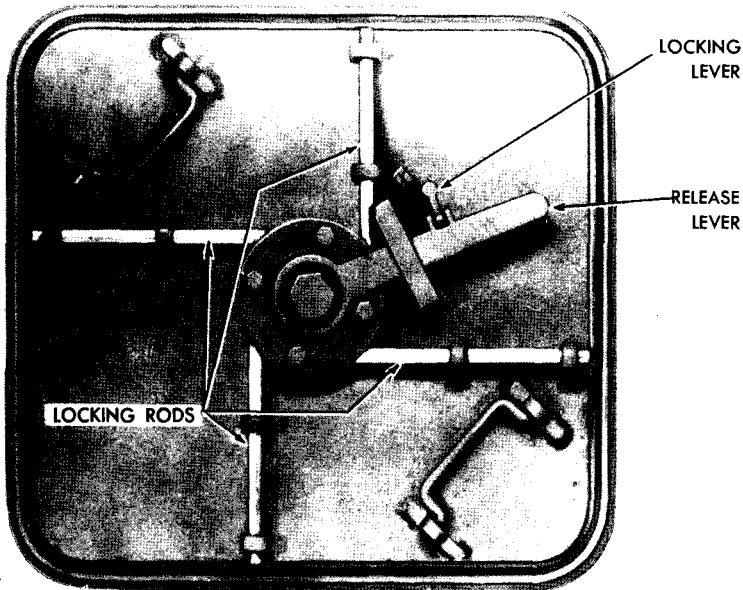
a. **General Description.** The hull of the vehicle is made of welded armor plate, 1½ inches thick at the front, 1 inch thick at the lower side plate, ¾ inch thick at the upper side plate, ¾ inch thick at the rear, and ¾ inch thick on top. The armor plates over the engine compartment are ⅜ inch thick. An apron of ¼-inch armor is provided for the upper part of each track. The hull is divided into two sections by a bulkhead; the engine compartment is located in the rear section, the fighting compartment and driver and assistant driver's stations are located in the front section. A pintle hook is provided on the rear of the vehicle for towing a trailer only. The pintle is attached to the hull by means of 4 bolts. The fighting compartment has a platform 16 inches above the hull floor. This platform is stationary and extends the full width of the vehicle, and runs lengthwise from the bulkhead to just behind the driver's compartment seats. The space beneath the platform contains storage compartments, battery box, and generator regulators which are reached through hinged metal covers flush with platform.

b. **Auxiliary Armor.** Provision is made for increasing the armor protection on the front and side upper slopes of the hull and on the sides of the turret by attaching auxiliary armor of varying thickness. Large circular bosses are welded to the armor plate of the vehicle. Holes in the auxiliary armor plates fit over these bosses. Heavy bolts, with large washers, screw into the center of the bosses to hold the auxiliary armor plate in place. A spacer surrounds each of the bosses, resulting in a ¾-inch air space between the hull and the auxiliary armor plate.

133. TURRET.

a. **Description.** The turret is made of welded armor plate 1 inch thick at the sides. The turret can be traversed through 360 degrees by hand-operated gear mechanism. The gun mount permits elevating the gun 30 degrees above the horizontal, for long range and direct firing, and depressing it 9 degrees below the horizontal. The front of the turret is protected by a heavy cast armor gun shield 2¼ inches thick.

## HULL AND TURRET



RA PD 28047

**Figure 93—Escape Hatch Cover**

b. **Turret Canopy.** A removable folding canopy, of heavy canvas, is provided for protection of the crew and the vehicle interior, for use to keep out rain or snow, or to shade the interior. It may be attached, by means of fold-down supports, to cover the opening in the turret top. The top of the canopy is then 12 inches above the rim of the turret opening.

### 134. ESCAPE HATCH.

a. The escape hatch is located in the vehicle floor back of the assistant driver's seat (fig. 93). The escape hatch is important to the safety of the crew and should be checked frequently for ease of operation. It should be removed, cleaned of dirt and rust, and its working parts lubricated at regular intervals.

### 135. VISION AND SIGHTING EQUIPMENT.

a. Two periscopes are provided for the driver, one in the driver's door, the other to his left, mounted in the hull top plate. The third periscope is in the assistant driver's door. All periscopes can be rotated. A tubular telescopic sight is provided at the left side of the gun. The opening through the gun shield for the telescope has a heavy protective shutter, operated from inside the turret.

3-INCH GUN MOTOR CARRIAGE M10A1

Section XXI

FIRE EXTINGUISHER SYSTEM

	Paragraph
Fire extinguisher units . . . . .	136
Operation . . . . .	137
Maintenance and replacement . . . . .	138
Handling . . . . .	139

**136. FIRE EXTINGUISHER UNITS.**

a. Two sizes of carbon dioxide fire extinguishers are carried in each vehicle. Two fixed 10-pound units are clamped in a vertical position near the transmission oil cooler on the floor of the fighting compartment (fig. 94). These units connect to tubes leading to the engine compartment and are used for extinguishing fires in the engine compartment only. A 4-pound portable hand-operated extinguisher is located on a bracket at left of the driver. A second 4-pound portable hand-operated extinguisher is located on a bracket in the turret.

**137. OPERATION.**

a. Operation of both the fixed and the portable fire extinguishers is explained in paragraph 5 b (14) (a) and (b).

**138. MAINTENANCE AND REPLACEMENT.**

a. **Maintenance.** After use, the extinguisher should immediately be exchanged for one that is fully charged. Every 4 months, or oftener if deemed necessary, weigh each extinguisher, and if the net weight of the carbon dioxide is less than 3½ pounds for the 4-pound extinguisher or 9 pounds for the 10-pound extinguisher, exchange the extinguisher for a fully charged one.

b. **Replacement of Cylinders.** To remove the fire extinguisher cylinders, unscrew the control head at the cylinder, loosen the clamps, and remove the cylinders. Recharge with 10 pounds of carbon dioxide, use adapter No. 23848. Reset the control handle. Reset the control head by inserting a pin in the shaft and turning counterclockwise until the clutch pin and the arrow are lined up. Reinstall the cylinder in vehicle, clamp in place, and connect the discharge tube. Assemble discharge head to recharged cylinder.

c. **Control Replacement.** To remove the pull cables, disconnect short conduit running from the fire extinguisher cylinder head to the inlet and outlet connector housing. Cut the cable at connector and pull cable out of conduit by pulling out handle at front and rear controls. Thread the new cable through conduit and connect cable (an installation drawing is included in the new parts package). To replace

FIRE EXTINGUISHER SYSTEM

DRIVERS COMPARTMENT  
4 LB. PORTABLE FIRE  
EXTINGUISHER

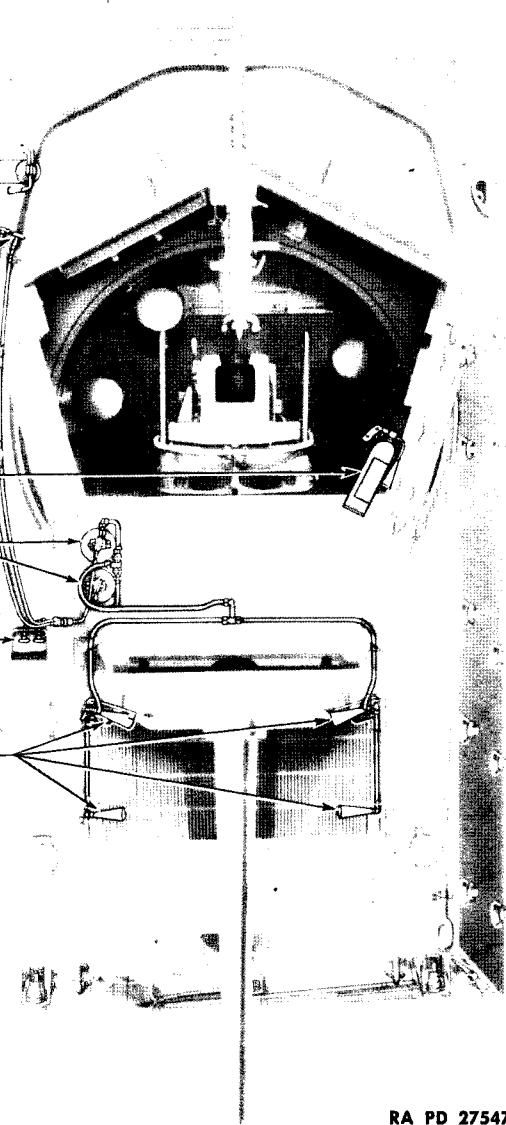
DRIVERS COMPARTMENT  
CONTROLS

TURRET 4 LB.  
PORTABLE FIRE  
EXTINGUISHER

2-10 LB. FIXED  
FIRE EXTINGUISHERS

OUTSIDE CONTROLS

NOZZLES



RA PD 27547

Figure 94—Fire Extinguisher System  
207



**3-INCH GUN MOTOR CARRIAGE M10A1**

conduits, remove cables as outlined and disconnect connectors and holding brackets. To reinstall, reverse the sequence of the steps in the removal procedure.

**d. Nozzles and Lines Replacement.** To replace fire extinguisher nozzles or lines, disconnect connections and holding brackets. Remove lines and nozzles. To reinstall, reverse the sequence of the steps in the removal procedure.

**139. HANDLING.**

**a.** Any cylinder containing gas under high pressure is as dangerous as a loaded shell. The extinguisher cylinders should never be dropped, struck, handled roughly, or exposed to unnecessary heat.

**PART THREE**

**ARMAMENT**

**Section XXII**

**INTRODUCTION**

	<b>Paragraph</b>
Scope .....	140
Characteristics .....	141
Data .....	142

**140. SCOPE.**

a. This part of the manual is designed to guide the commander and crew in the care and handling of the 3-inch Gun M7 and Mount M5, mounted on Gun Motor Carriage M10A1.

b. In addition to mounting the 3-inch Gun M7 and Mount M5, the Gun Motor Carriage M10A1 mounts the cal. .50 M2, heavy barrel, machine gun; Thompson submachine gun, cal. .45; the cal. .30 rifle, M1903; carbines, cal. .30; grenade, and launcher for cal. .30 rifle.

c. All essential information that is of a technical character required by using arms and services for identification, use, and care of the particular equipment described, is contained in this manual, as well as use and care of ammunition, spare parts and accessories, and sighting and fire-control equipment.

d. Disassembly and assembly, and repairs by battery personnel will be undertaken only under supervision of an officer or chief mechanic.

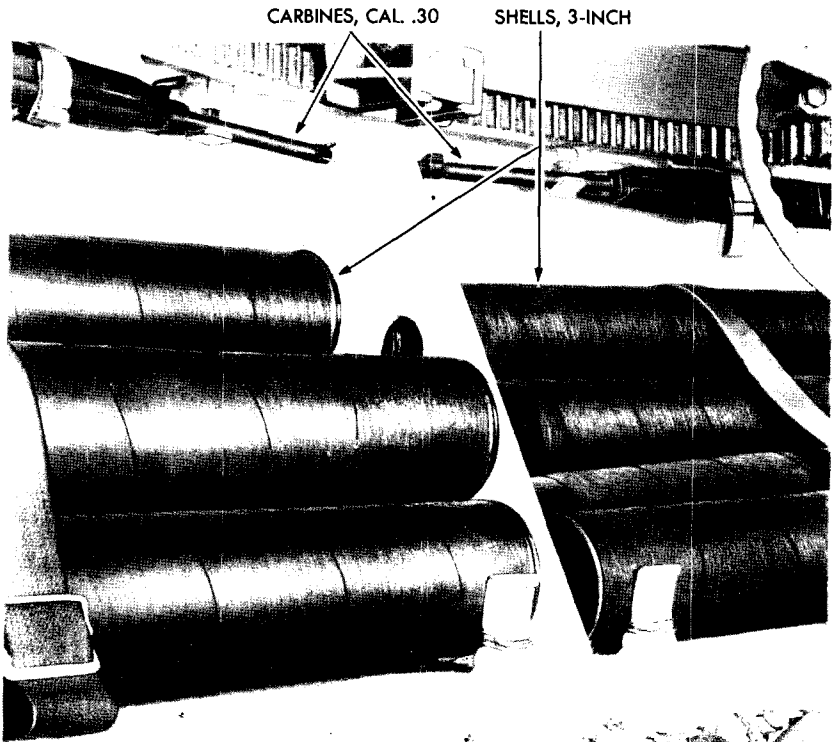
e. In cases where the nature of repair, modification, or adjustment is beyond the scope and/or facilities of battery personnel, local or otherwise designated ordnance service should be informed in order that trained personnel with suitable tools and equipment may be provided.

f. All Technical Manuals, Field Manuals, Standard Nomenclature list, and other publications pertaining to materiel described in this manual are listed in "References."

**141. CHARACTERISTICS.**

a. The main armament of the Gun Motor Carriage M10A1 is a 3-inch Gun M7 that is mounted in a Gun Mount M5. The gun is mounted in a semiopen-top turret of welded armor plate.

b. The 3-inch Gun M7 is used as a tank destroyer. The gun has a

**3-INCH GUN MOTOR CARRIAGE M10A1**

RA PD 45690

**Figure 95—Ammunition and Carbines Stored Under Right Side of Turret**

gun shield that moves vertically with the barrel and forms the front part of the turret. The turret and gun as a unit are traversed by means of a handwheel mechanism meshing with a ring gear, thereby enabling the gun to be fired in any direction. Two traversing locks are provided to secure the turret in any desired position.

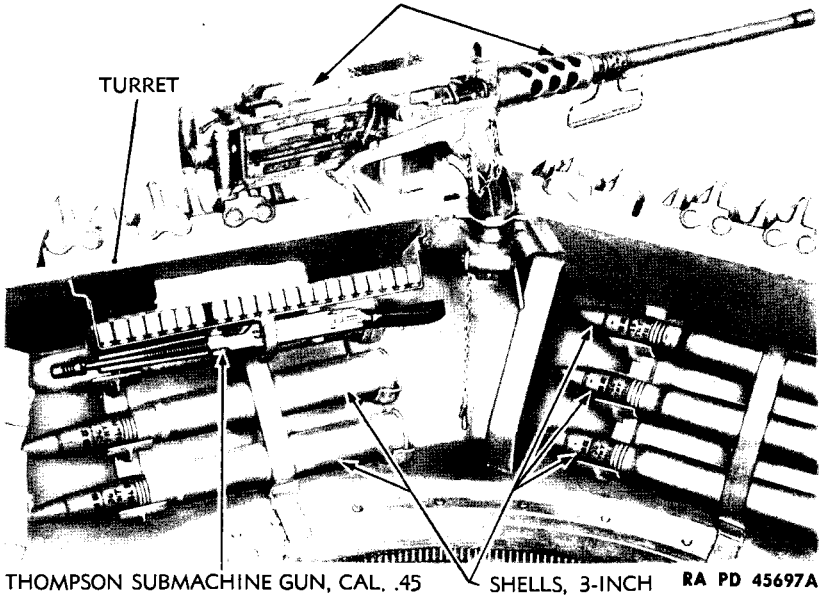
c. Elevation of the gun is by means of two elevating handwheels, one on the right, and the other on left side of cradle. The muzzle of the gun can be elevated to 30 degrees or depressed to 10 degrees.

d. There are 54 AP and HE shells stored and carried on the vehicle (figs. 95 and 96).

e. The breech can be automatically or manually opened or closed. The gun can be electrically or hand fired. Firing mechanism is usually automatically cocked, but can be hand cocked by means of a hand-cocking lever. All rounds are loaded by hand. NOTE: It should be remembered that the driver and the assistant driver cannot open their latch doors while the 3-inch gun is pointed forward, because of interference with the gun shield. However, the gun will normally be carried

INTRODUCTION

CAL. .50 HEAVY BARREL MACHINE GUN M2



**Figure 96—Rear Inside View of Turret.**

with the muzzle to the rear (fig. 97), and both doors may be left open until the gun is to be directed toward the front.

f. Small arms are covered in the 23 series Field Manuals which are available to using arms. These weapons will not be included here.

**142. DATA.**

**a. Gun.**

Weight of 3-inch gun (M7) complete	1,990 lb
Length of bore	.50 cal
Length of tube, muzzle to rear face of breech ring	158.10 in.
Caliber	3 in.
Type of breechblock	Vertical-sliding
Firing chamber capacity	200 cu in.
Density of loading	0.692
Muzzle velocity	2,600 ft per sec
Muzzle energy	702.9 ft-ton
Maximum powder pressure	36,000 lb
Rifling:	
Length	126.85 in.
Number of grooves	28
Twist, uniform right-hand with one turn in calibers	40
Chamber pressure	3,200-3,600 lb per sq in.

**3-INCH GUN MOTOR CARRIAGE M10A1**



RA PD 45691

**Figure 97—Rear End of Motor Carriage M10A1**

Number of grooves.....	28
Depth of grooves.....	0.04 in.
Width of grooves.....	0.1866 in.
Width of lands.....	0.15 in.

**b. Ammunition.**

Weight of fixed round.....	26.66 lb
Weight of powder charge.....	5 lb
Travel of projectile in barrel.....	127.73 in.
3-inch ammunition stored (AP and HE).....	54 rounds
HE round, M42 B2, weight of projectile.....	12.4 lb
AP round, M62, weight of projectile.....	15 lb
AP round, M79, weight of projectile.....	15 lb
Approximate drop of projectile at zero degree of elevation.....	2,000 to 2,500 yd

**c. Electrical.**

Firing switch (in elevating handwheel).....	15 amperes 24 d-c volts, normal position, open
---	--

**INTRODUCTION**

Firing solenoid . . . . . 24 volts, 30 lb pull  
(Maximum air gap at  
20 d-c volts)

**d. Mount.**

Elevation of gun . . . . . 30 degrees  
Depression of gun . . . . . 10 degrees  
Traversing . . . . . 360 degrees  
Type of recoil mechanism . . . . . Hydrospring  
Normal recoil . . . . . 11 to 12 in.  
Maximum recoil . . . . . 14 in.  
Type of recoil oil used . . . . . OIL, recoil, heavy  
(Spec. 2-96A)  
Recoil spring compression . . . . . 12 in.  
Recoil spring, number of coils . . . . . 20½ approx.  
Recoil spring, length compressed in recoil cylinder . . . . . 26.375 in.  
Recoil spring, length of free spring . . . . . 38.375 in.  
Recoil spring tension, gun in battery . . . . . 1,058 lb min  
Recoil spring tension, gun in battery . . . . . 1,136 normal  
Recoil spring tension, gun in battery . . . . . 1,214 lb max  
Elevating handwheel, one revolution produces vertical move-  
ment of . . . . . 0.0833 in.  
Elevating handwheel, movement to raise muzzle . . . . . Clockwise  
Recoil piston rod pull . . . . . 10,500 lb

**e. Sighting Equipment.**

Telescope . . . . . M51

**3-INCH GUN MOTOR CARRIAGE M10A1**

**Section XXIII**

**DESCRIPTION AND FUNCTIONING OF GUN**

	<b>Paragraph</b>
General .....	143
Barrel assembly .....	144
Breech mechanism .....	145
Closing spring mechanism .....	146
Percussion and cocking mechanism .....	147
Function and operation of breech mechanism .....	148

**143. GENERAL.**

a. The 3-inch Gun M7 consists of a tube screwed into a breech ring and locked by a key.

b. The tube is supported and alined in a cradle that is a part of the mount assembly. The rear half of the tube is finish-ground and rides in bushings inside of the cradle.

c. Lugs on the sides of the breech ring provide the means of attaching the two recoil cylinder assemblies which are a part of the gun mount. Lugs on the bottom of the breech ring are for the breechblock operating shaft and cranks. The breech closing spring mechanism is attached to a lug on right side of breech ring. Interior of breech ring is machined so that breechblock can slide upward to close and downward to open the firing chamber.

d. Gun designation, serial number, name of manufacturer, year of manufacture, and weight (includes tube, breech ring, and breechblock) are stamped on the top of the breech ring.

e. Tube serial number, name of manufacturer, weight of tube with breech, and gun designation are stamped on the muzzle. The muzzle end of tube is engraved with witness lines for use with bore-sighting equipment.

f. Rounds are loaded by hand, and the action of loading causes automatic closing of the breech; however, the breech can be manually opened (or closed) by use of the breech operating handle which is secured to the breech operating shaft. The gun is fired electrically by means of a solenoid or manually by a hand-firing lever. In either case, the act of firing depresses a firing plunger located on the right cheek of breech ring. The firing plunger moves the sear, thereby allowing the firing pin to function. After firing, the gun recoils and then counter-recoils to battery. During this counterrecoil, the gun is cocked, breech is opened, cartridge case is extracted, and breechblock is locked in its open position (firing chamber open) ready to receive the next round.

**DESCRIPTION AND FUNCTIONING OF GUN****144. BARREL ASSEMBLY.****a. Tube.**

(1) The tube is formed in one piece and is threaded (at the breech end) to screw into the breech ring. The bore is rifled from the chamber to the muzzle with a uniform right-hand twist of one turn in 40 calibers, and the bore is also tapered to form a firing chamber. The portion of the tube that rests in the cradle is finish-machined, in order to assure a bearing for supporting the tube.

(2) The face of the breech end of the tube is recessed on each side of the bore to form a cam surface for the upper ends of the extractors when they are in battery position. Extraction of a fired cartridge case is accomplished by means of these extractors.

(3) A longitudinal breech ring key slot is machined in the circumference of the shoulder, which is at the rear end of the tube and just ahead of the threads that hold the tube to the breech ring. The breech ring key is installed in this slot and locks the tube to the breech ring. The key also prevents rotation of the gun in its mount.

**b. Breech Ring.**

(1) The breech ring, into which the tube is screwed, has two lugs projecting from the sides. These lugs are the means of anchoring the rear ends of the recoil mechanism. A screw in the breech ring forces a copper plug into the threads of the recoil rod to secure the rod to the breech ring. Two lugs project downward from the bottom of the breech ring. The lugs are bored transversely and fitted with bushings in order to provide bearings for the operating crank and chain terminal crank.

(2) An additional support on the lower right side of the breech ring is bored longitudinally to receive the rear end of the closing spring cylinder. Holes are tapped in the breech ring for screws to hold the closing spring cylinder, breech ring key, operating crank detent, breechblock bushing, and recoil rods.

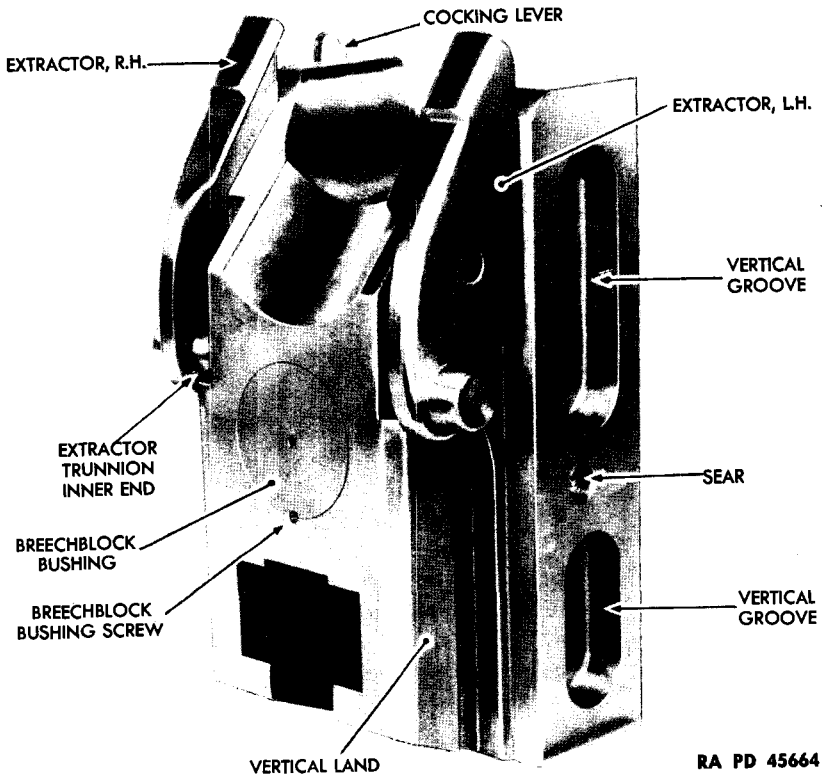
(3) Front face of breech ring has a shallow vertical keyway for the breech ring key. The front of this keyway terminates in a square notch through the front face of the breech ring, the notch alining with a keyway in the tube. The breech ring key is retained in the breech ring by two socket head setscrews, thereby locking the tube to the breech ring.

(4) Near the rear of the breech ring is a rectangular recess which extends through the breech ring from top to bottom and houses and guides the breechblock. The rear side of this rectangular recess is cut out at the top to form a U-shaped notch in order to clear the cartridge case when loading and ejecting. The surface around the U-shaped opening is rounded to facilitate loading of the gun.

(5) The right side wall at the top of the breech recess is machined



3-INCH GUN MOTOR CARRIAGE M10A1

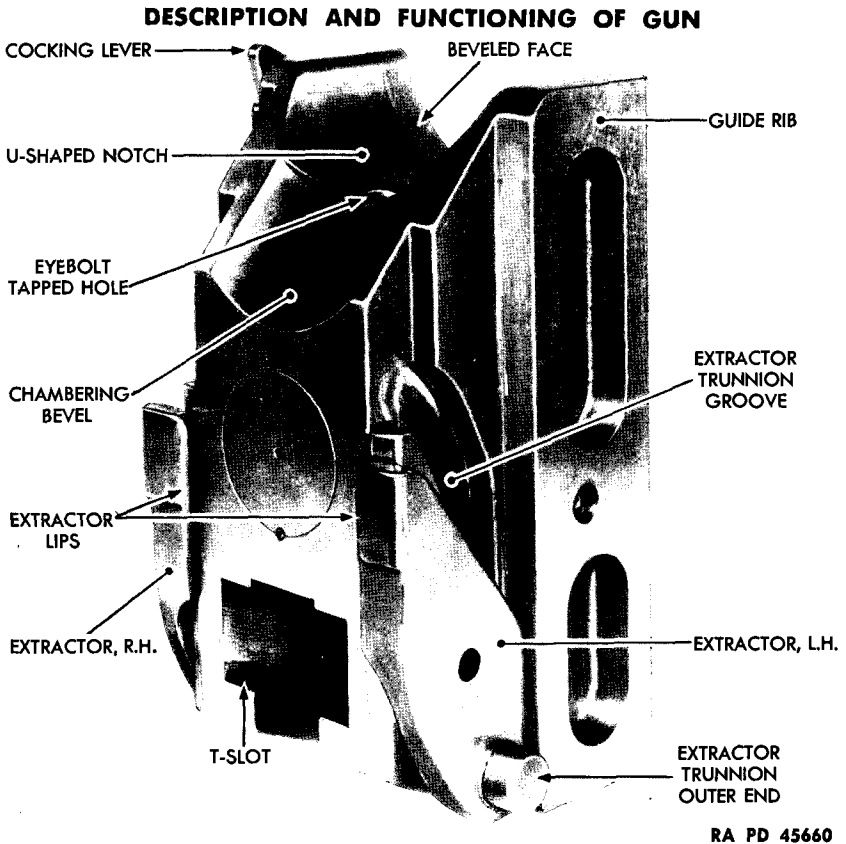


**Figure 98—Breechblock and Extractors—Battery Position**

from the rear corner forward to provide clearance for the cocking lever arm. The cocking lever is actuated by the cocking lever arm either in automatic or manual cocking. Near the front of the inner walls of the breech ring are short curved slots (one on each side) for the purpose of guiding the outer trunnions of the extractors. Two holes in the rear face of the breech ring extend forward into the extractor trunnion recesses and house the two extractor plungers and springs. The rear ends of the two holes are threaded to accommodate the two extractor plunger plugs.

(6) A hole in the right cheek of the breech ring is counterbored and threaded to receive the firing plunger and firing plunger retainer. Two tapped holes and a pilot hole near the rear of the right cheek are used to locate and attach the operating handle stop.

(7) Breech operating handle is attached to right end of the breech operating shaft and contains the operating handle latch and latch spring. The function of the breech operating handle is to provide a manual means of opening or closing the breech.



**Figure 99—Breechblock and Extractors—Breech Open**

(8) The breech ring provides a housing for the rear end of the tube, the breech mechanism, and the percussion firing mechanism. The rear ends of the two recoil rods and closing spring mechanism are also attached to the breech ring.

c. **Breech Ring Key.** The rectangular breech ring key fits in a keyway in front face of breech ring and also engages a key seat in the tube.

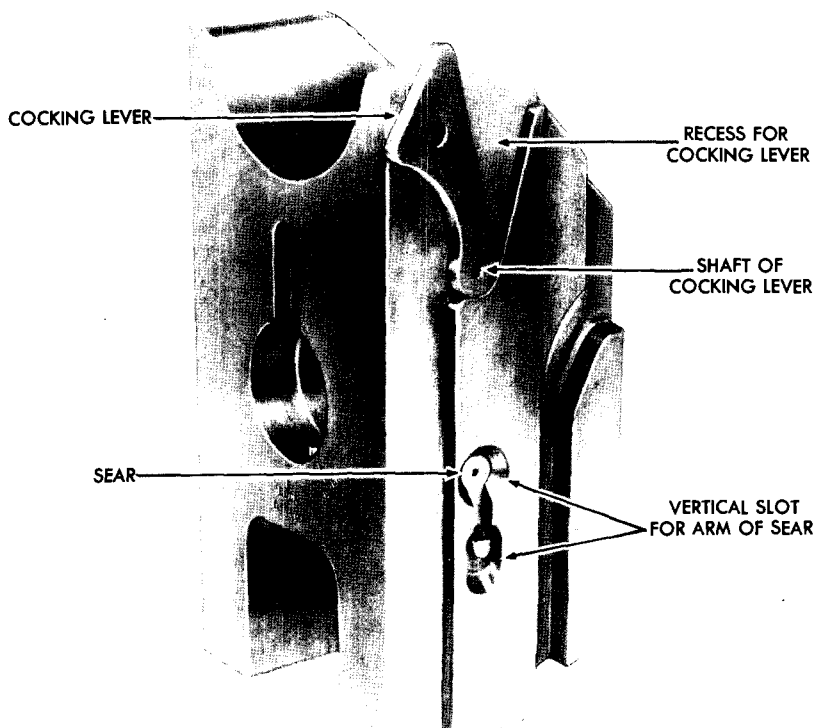
## 145. BREECH MECHANISM.

### a. General.

(1) The breech mechanism consists of a breechblock with percussion firing mechanism, breech operating shaft with the breechblock operating crank, chain terminal crank, and operating crank.

(2) The functions of this breech mechanism are, first, to close the rear end of the chambers after loading; second, to fire the round of ammunition after it has been inserted; and finally, to extract the empty cartridge case from the firing chamber.

3-INCH GUN MOTOR CARRIAGE M10A1



RA PD 45698

**Figure 100—Rear Right Quarter View of Breechblock**

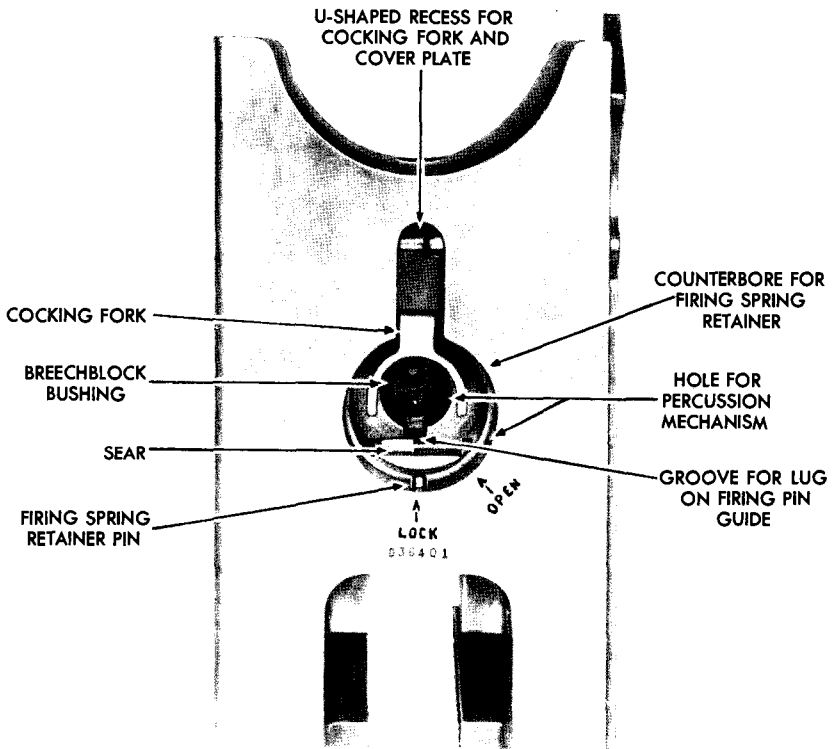
**b. Breechblock.**

(1) The breechblock is of the vertical sliding type and has a guide rib on each side which slides in a corresponding groove in each side of the breech ring recess (figs. 98 and 99).

(2) The top of the breechblock is U-shaped in order to guide the cartridge into the firing chamber (at rear end of tube). This U-shaped notch is lined with the bottom of the U-shaped notch in the breech ring so that the cartridge case is cleared when the breechblock is in its lowered position. The upper front edge of the top of the breechblock is beveled in order to drive the cartridge into the firing chamber as the breechblock is raised. The rear face of the breechblock, the guide ribs of the breechblock, the grooves in the breech ring (for the guide ribs of the breechblock), and the rear wall of the breech ring recess, are all inclined so that when the breechblock rises, it also moves forward and thereby completes the seating (chambering) of the round in the firing chamber (figs. 98 and 99).

(3) The bottom of the breechblock contains an inclined T-slot in

DESCRIPTION AND FUNCTIONING OF GUN



RA PD 45669

**Figure 101—Rear View of Breechblock**

which cross heads of the breechblock operating crank slide in order to raise or lower the breechblock assembly (figs. 98 and 99).

(4) In each side of the breechblock is a groove in which the inner ends of the extractor trunnions of the two extractors slide. The lower ends of these grooves are parallel to the breechblock guides; however, the upper ends curve toward the breechblock front face in order to impart an accelerated motion to the extractors when extracting and ejecting a fired cartridge case (figs. 98 and 99).

(5) There are flats on the vertical lands (on each side of the breechblock). These lands provide a surface for corresponding flats on the inner trunnions of the extractors. The breechblock is locked in its open position when the flats of the inner trunnions of the extractors are on the vertical lands of the breechblock (figs. 98 and 99).

(6) A hole, which is bored through the center of the breechblock, houses the percussion firing mechanism (fig. 101). The forward end of this hole is counterbored and threaded for a breechblock bushing, which is retained in the breechblock by a breechblock bushing screw.

**3-INCH GUN MOTOR CARRIAGE M10A1**

The central part of the hole has a longitudinal groove for a lug that is on the firing pin guide; and at the rear of the hole, the breechblock is counterbored to house the firing spring retainer. The upper side of this counterbore has an inverted U-shaped recess to house the cocking fork plunger, spring, and cover plate. A small vertical hole in the bottom of the counterbore and toward the rear is for a firing spring retainer pin. This pin and the cover plate lock the firing spring retainer in the breechblock. Arrows are engraved on the rear face of the breechblock to show the LOCK and OPEN positions of the firing spring retainer.

(7) A transverse hole bored through the breechblock (fig. 100) intersects the lower side of the central bore and is for housing the sear, sear spring, and sear retainer. The left end of this transverse hole is counterbored to form a seat for the U-shaped sear retainer. The right end of the transverse hole has a vertical slot for the arm of the sear (fig. 7).

(8) A V-shaped recess in the upper right rear side of the breechblock is to provide clearance between the breechblock and breech ring for the cocking lever. A transverse bore from this V-shaped recess extends into the central recess. This transverse bore is the bearing for the shaft of the cocking lever (fig. 100).

(9) The weight of the breechblock is reduced by cutting vertical grooves into each side of the breechblock (fig. 98). A tapped hole in the top of the breechblock is for an eyebolt to facilitate removing or installing the breechblock in the breech ring (fig. 99).

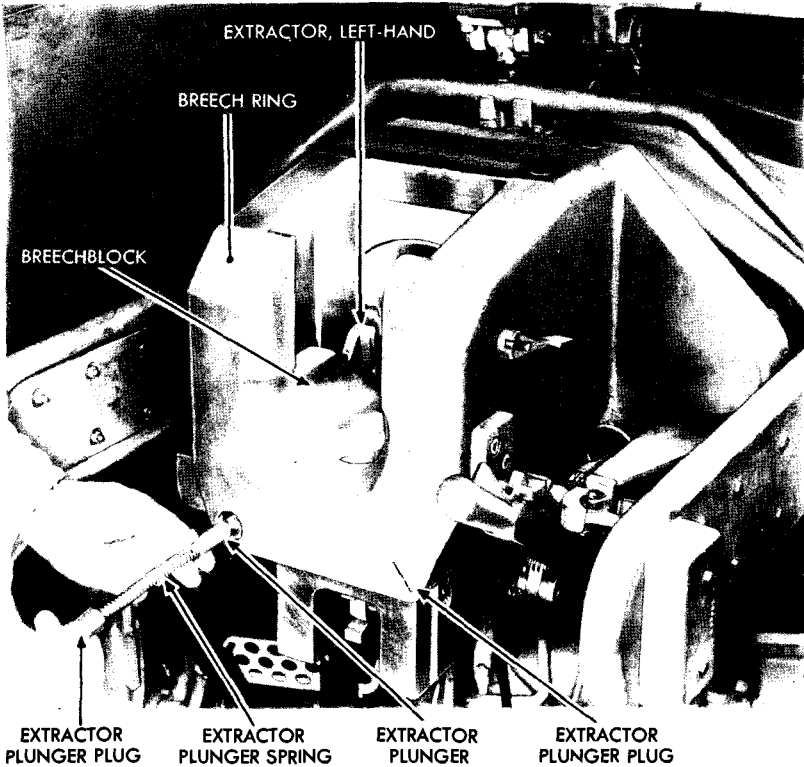
**c. Extractors (figs. 98 and 99).**

(1) The right and left extractors are short, heavy levers that are supported vertically between the sides of the breechblock and the side walls of the breech ring recess.

(2) Each side of the lower end of the extractor carries a trunnion that projects outward and inward from the extractor (figs. 98 and 99). The outer trunnions are located in short curved grooves in the walls of the breech ring recess; and these outer trunnions prevent any vertical movements of the extractors. The inner trunnions slide in curved grooves in the sides of the breechblock; and as the breechblock is raised or lowered, these inner trunnions are forced forward or backward by the curve of the grooves assisted by the extractor spring plungers for the extraction of a cartridge case. The forward edge of each extractor has a radius that rides against the front face of the breech ring and assists in the control of the extractors.

(3) The function of the extractors is to extract and eject a cartridge case. This is accomplished by means of the inward projecting lips on the upper ends of the extractors, which lie in recesses in the breech face of the tube and under the rim of the cartridge when the breech is closed. The front edges of the extractors are curved convexly

DESCRIPTION AND FUNCTIONING OF GUN



RA PD 45654

**Figure 102—Extractor Plunger, Spring, and Plug**

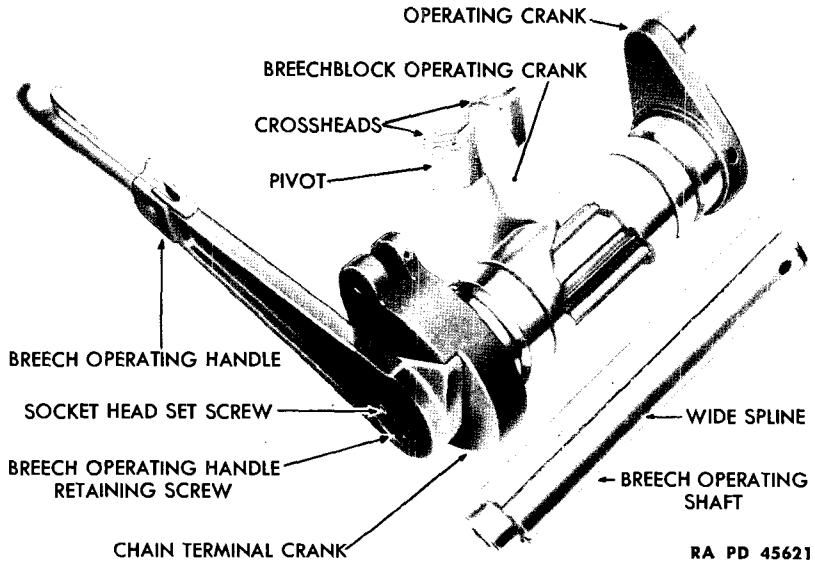
and have a rolling contact with the front wall of the breech ring recess. When the lower ends of the extractors are forced forward by the downward or opening movement of the breechblock, the extractor upper ends and lips are rocked rearward, thereby prying the cartridge case out of the firing chamber. The rolling contact with the front wall of the breech ring recess produces an accelerated motion in order to throw the cartridge case clear of the gun.

**d. Extractor Plungers.**

(1) Small cylindrical extractor plungers slide in longitudinal holes that extend from the rear face of the breech ring to extractor trunnion pockets in the side walls of the breech ring recess. Extractor plunger springs are in the rear ends of these holes. These springs bear rearward against extractor plunger plugs that are screwed into the holes. The extractor plunger plugs press the extractor plunger springs against the extractor plungers and these plungers press against the outer trunnions of the extractors.

(2) The function of the extractor plungers is to assure the positive

3-INCH GUN MOTOR CARRIAGE M10A1



RA PD 45621

**Figure 103—Breech Operating Shaft and Cranks**

locking of the breechblock in its open position. This is accomplished by the extractor plungers pressing the outer trunnions of the extractors forward until the flats on inner trunnions are on the flats of the vertical lands which are on the breechblock.

**e. Breech Operating Shaft (fig. 103).**

(1) The breech operating shaft provides a means of connecting and operating the three cranks (operating crank, chain terminal crank, and breechblock operating crank) in order to cause them to rotate as a unit.

(2) There is an extra wide spline or land on the breech operating shaft that mates with a groove of the same width in the hub of each of the three cranks. The three cranks cannot be incorrectly installed or misaligned with each other.

(3) The shoulder and hole on the right end of the breech operating shaft are provided for the attaching of the breech operating handle by means of a breech operating handle retaining screw and a socket head setscrew. The left end of the shaft is drilled, radially, to provide a seat for the operating shaft detent and to house the operating shaft plunger. The small hole in the end of the shaft is for the plunger retaining screw.

**f. Breechblock Operating Crank (fig. 103).**

(1) The breechblock operating crank consists of an internally splined hub which slides on the central part of the breech operating shaft, in between the bottom lugs on the breech ring. The breechblock

## DESCRIPTION AND FUNCTIONING OF GUN

operating crank is, therefore, both supported and actuated by the breech operating shaft.

(2) A central lever arm on the breechblock operating crank extends rearward and upward, terminating in a pivot that extends to the right and to the left. On the pivot are two bronze cross heads that engage and slide in the T-slot in the breechblock.

(3) A small hole in the cross head extends from the upper and lower surfaces to the pivot hole to provide for the passage of lubricant. An arrow and words "MUZZLE FACE" are engraved on each cross head to insure the correct installing of the cross heads on the pivot.

(4) The hub of the breechblock operating crank has a lug that projects rearward and contacts a stop surface on the bottom of the breech ring in order to limit the downward travel of the breechblock.

(5) The function of the breechblock operating crank is to provide a means of actuating the breechblock into an open or closed position.

### g. Operating Crank (fig. 103).

(1) Operating crank consists of a hub that is internally splined. Externally, the crank has a cylindrical machined surface, except for a short integral lever which extends upward and has a terminal lug projecting outward for actuation by an operating crank ejector cam located on the cradle.

(2) Splined interior of hub slides onto the left end of the splined breech operating shaft, while the cylindrical exterior surface is supported in a bronze bushing in the transverse bore of a lug on the breech ring.

(3) On the cylindrical machined surface of the operating crank is an annular groove that enables an operating crank detent (screwed into the breech ring so as to engage in the annular groove) to maintain the position of the operating crank.

(4) The hub of the operating crank is drilled and counterbored radially for the breech operating shaft detent and breech operating shaft detent spring, to retain the breech operating shaft in its position in the breech ring.

(5) The function of the operating crank is to open the breech and eject the cartridge case, automatically, when contacted by the operating crank ejector cam during the recoil and counterrecoil of the barrel.

### h. Chain Terminal Crank (fig. 103).

(1) The chain terminal crank consists of a hub that is internally splined and externally has a cylindrical machined surface, except for a short integral lever extending upward and terminating in a fork for attaching the chain terminal of the breech closing spring mechanism.

(2) Splined interior of hub slides onto the right end of the splined breech operating shaft while the cylindrical exterior surface is supported in a bronze bushing in the transverse bore of a lug on the breech ring.



### 3-INCH GUN MOTOR CARRIAGE M10A1

(3) In the cylindrical machined surface of the operating crank is an annular groove that enables an operating crank detent (screwed into the breech ring so as to engage in an annular groove) to maintain the position of the chain operating crank.

(4) The function of the chain terminal crank is to provide a means by which the breech closing spring mechanism can raise the breechblock into a closed position.

i. **Firing Plunger.** The firing plunger is cylindrical in form with an integral collar near the middle of the plunger. The firing plunger is retained in a bored hole through the right side of the breech ring (fig. 98). The flat inner end of the firing plunger is in alignment with an arm on the sear when the breechblock is in its closed position. The rounded outer end of the firing plunger projects outward from the breech ring so that it can be operated by the firing mechanism on the mount. The firing plunger is held in the breech ring by firing plunger retainer.

#### 146. CLOSING SPRING MECHANISM.

a. **General.** Closing spring mechanism consists of a coil spring on a piston rod which has a piston on its forward end and a chain on its rear end. The entire assembly is housed in a closing spring cylinder.

##### b. Construction (fig. 104).

(1) The closing spring cylinder is attached at its rear end, by screws, to a lug that is a part of the breech ring. A shoulder inside the closing spring cylinder forms a seat for the closing spring.

(2) The piston rod is drilled and slotted at its rear end for attaching it to the piston rod chain by means of a link pin and cotter pin. The front end of the piston rod is threaded for the closing spring piston rod nut and a series of holes are equally spaced along this threaded part of the rod so that the piston rod nut can be adjusted and secured by means of a cotter pin. Adjustment of the breechblock closing action is accomplished by turning the closing spring piston rod nut up or down on the piston rod and inserting the cotter pin in a different hole.

(3) The closing spring piston fits freely inside the closing spring cylinder and the piston is centrally bored for a loose encirclement of the piston rod. A shoulder at the front end of the piston provides a seat for the closing spring.

(4) The closing spring piston rod nut is tapped to screw onto the piston rod, and the rear end of the nut is machined to form a cylindrical sleeve that projects into the closing spring piston to maintain alignment of the nut and piston. The forward end of the nut is hexagonal to provide a means of adjustment of breechblock closing action.

(5) The closing spring is a heavy helical compression spring. The chain is a commercial steel leaf or balance chain. The chain terminal is a small steel block which is tapered in thickness having the thinner

## DESCRIPTION AND FUNCTIONING OF GUN

end slotted and drilled for attachment to the chain terminal crank by means of a link pin.

### c. Function.

(1) The function of the closing spring mechanism is to close the breech. This is accomplished by compressing the closing spring and using the force of the compressed spring. When the breech operating shaft and the chain terminal crank are rotated, the closing spring piston is pulled rearward and into the closing spring cylinder.

(2) The closing spring piston compresses the closing spring which closes the breech as soon as the extractors are off the flats of the breechblock vertical lands. Insertion of a round in the firing chamber or manual release pushes the extractors off their locked position and allows closing spring to function and close the breech.

## 147. PERCUSSION AND COCKING MECHANISM.

### a. General (fig. 105).

(1) The percussion mechanism consists of the firing pin guide, firing pin, firing pin retracting spring, firing spring stop, and firing pin guide pin. The cocking mechanism consists of the cocking lever, cover plate, cocking fork plunger, cocking for plunger spring, and cocking fork.

(2) The firing pin guide is a cylindrical cup which slides backward and forward in the central bore of the breechblock, with the closed end of the guide facing forward. The firing pin guide contains the firing pin, firing pin retracting spring, firing pin guide pin, firing spring stop, and the forward end of the firing spring.

(3) There are four exterior lugs on the firing pin guide. The larger of the two on the lower side of the guide serves for engagement with the sear, while the smaller lug near the front acts as a guide in the groove of the breechblock bore. Two lugs on the rear of the firing pin guide extend outward so that the cocking fork engages them and thus actuates the guide to cock the gun.

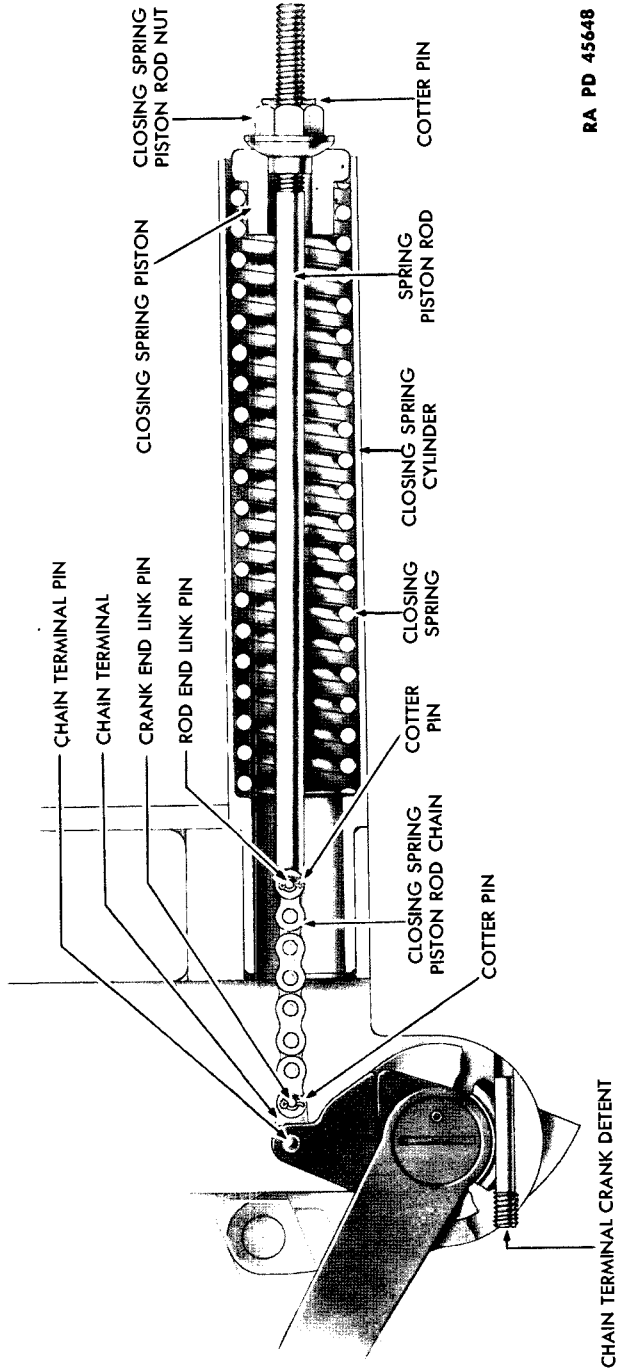
### b. Construction (fig. 105).

(1) The firing pin is a shouldered screw having a slotted head and a small cylindrical flat point. The firing pin is installed from the rear end of the firing pin guide and then screwed into the front end of the guide. The firing pin guide pin is inserted through a hole in the firing pin and firing pin guide, thereby securing each part to the other.

(2) The firing spring stop is a ring having two projections protruding from its front face. These projections fit freely in two openings in the front end of the firing pin guide. The firing spring stop is held in a forward position by the firing pin retracting spring. The purpose of the stop is to maintain clearance between the firing pin and the cartridge.

(3) The firing pin retracting spring is a light helical compression spring mounted on the body of the firing pin. The spring bears against

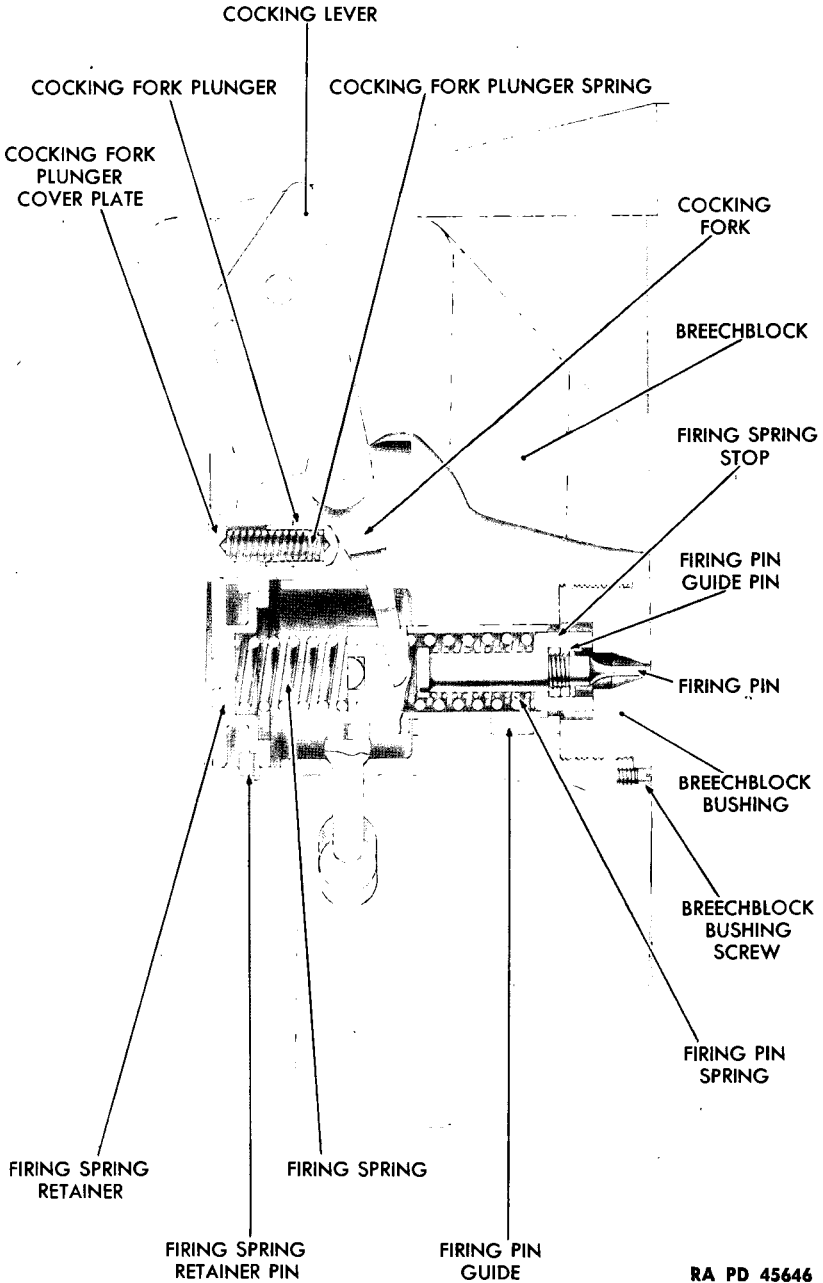
3-INCH GUN MOTOR CARRIAGE M10A1



RA PD 45648

Figure 104—Closing Spring Mechanism

DESCRIPTION AND FUNCTIONING OF GUN



RA PD 45646

Figure 105—Firing Mechanism Assembly  
227

**3-INCH GUN MOTOR CARRIAGE M10A1**

the head of the firing pin and against the firing spring stop, maintaining a constant pressure against the stop to force it against the forward end of the firing pin guide.

(4) The firing spring is a helical compression spring extending into the rear end of the firing pin guide and resting against the firing spring stop. The rear end of the spring seats in a recess in the firing spring retainer. The firing spring forces the firing pin guide forward to fire the round whenever the sear is released by the act of firing.

(5) The firing spring retainer is a cylindrical plug that closes the rear end of the central bore in the breechblock. The forward end of the retainer is recessed to form a seat for the firing spring. A groove is cut in the circumference of the retainer, forming a front and rear land. The front land is notched to engage a firing spring retainer pin (in breechblock) and also to engage a lug that is on the cover plate. The rear face of the retainer is slotted to facilitate removal and replacement of the retainer. The rear face of the retainer is marked with an arrow on the lower vertical centerline that aligns with the word "OPEN" or the word "LOCK" (on rear face of breechblock) (fig. 101) to remove or install the percussion mechanism.

(6) The sear is a cylindrical bar which slides transversely in the breechblock and engages a lug on the firing pin guide for the purpose of holding the percussion mechanism in its cocked position. The sear is notched where it engages the lug on the firing pin guide, and release of the percussion mechanism to fire the round is accomplished by moving the sear endwise, out of engagement with the firing pin guide.

(7) The cocking fork consists of a hub with a forked arm which straddles the firing pin guide. The cocking fork contacts lugs on each side of the firing pin guide. When the percussion mechanism is moved rearward to its cocked position, it is the cocking fork that forces the percussion mechanism rearward. The cocking fork pivots on the cocking lever and is keyed to the inner end of the lever.

(8) The cocking lever consists of a cylindrical shaft which is flattened at one end to fit into the hub of the cocking fork. The opposite end of the cocking lever is formed into a curved arm. The cylindrical shaft end of the cocking lever operates in a transverse bore in the breechblock. The curved arm end of the cocking lever extends upward also toward the rear and is located between the right side of the breechblock (fig. 100) and the breech ring. The rear curved portion of the cocking lever extends over the rear wall of the breech ring, when the breechblock is in closed position (fig. 98). Automatic cocking of the percussion mechanism is obtained by lowering (opening) the breechblock which causes the cocking lever to ride over a cam surface of the cocking arm.

(9) The cover plate closes the rear opening (above the firing spring retainer) of the recess in the breechblock. A curved portion at the top of the cover plate fits the recess in the breechblock, and a con-

## DESCRIPTION AND FUNCTIONING OF GUN

cave lower edge of the cover plate rests against the firing spring retainer. Flanges on both sides of the cover plate engage grooves on the inner wall of the recess in the breechblock. A lug which projects downward from the bottom of the cover plate retains the upper side of the firing spring retainer. The front face of the cover plate is drilled in order to house the cocking fork plunger and spring.

(10) The cocking fork plunger is a cylindrical plug which presses forward on the lower side of the cocking fork hub, thereby returning the cocking fork and cocking lever into their rearward or uncocked position as soon as the cocking lever is released. The cocking fork plunger is drilled to receive the cocking fork plunger spring which rests against the cover plate and presses forward on the cocking fork plunger.

(11) The function of the percussion mechanism is to provide a means of moving a firing pin forward to strike the cartridge primer. The function of the cocking mechanism is to provide an automatic means of moving the percussion mechanism into its cocked position after a round has been fired. The opening of the breechblock moves the cocking lever to which the cocking fork is keyed. The cocking fork moves the percussion mechanism rearward where the sear engages and holds the percussion mechanism in a cocked position until the firing plunger is moved by either electric or hand firing. The firing plunger then pushes in on the sear, thereby releasing the percussion mechanism which allows the firing spring to force the firing pin guide forward until the stop comes in contact with the inner face of the breechblock bushing. Inertia of the forward movement of the guide carries the guide forward until the firing pin strikes the cartridge primer. The firing pin retracting spring then returns the firing pin guide to position within the breechblock.

### 148. FUNCTION AND OPERATION OF BREECH MECHANISM.

#### a. General (figs 106 and 107).

(1) The breechblock mechanism slides up and down in its recess in the breech ring, thereby either opening the firing chamber for loading or closing the firing chamber for firing of the round (figs. 106 and 107).

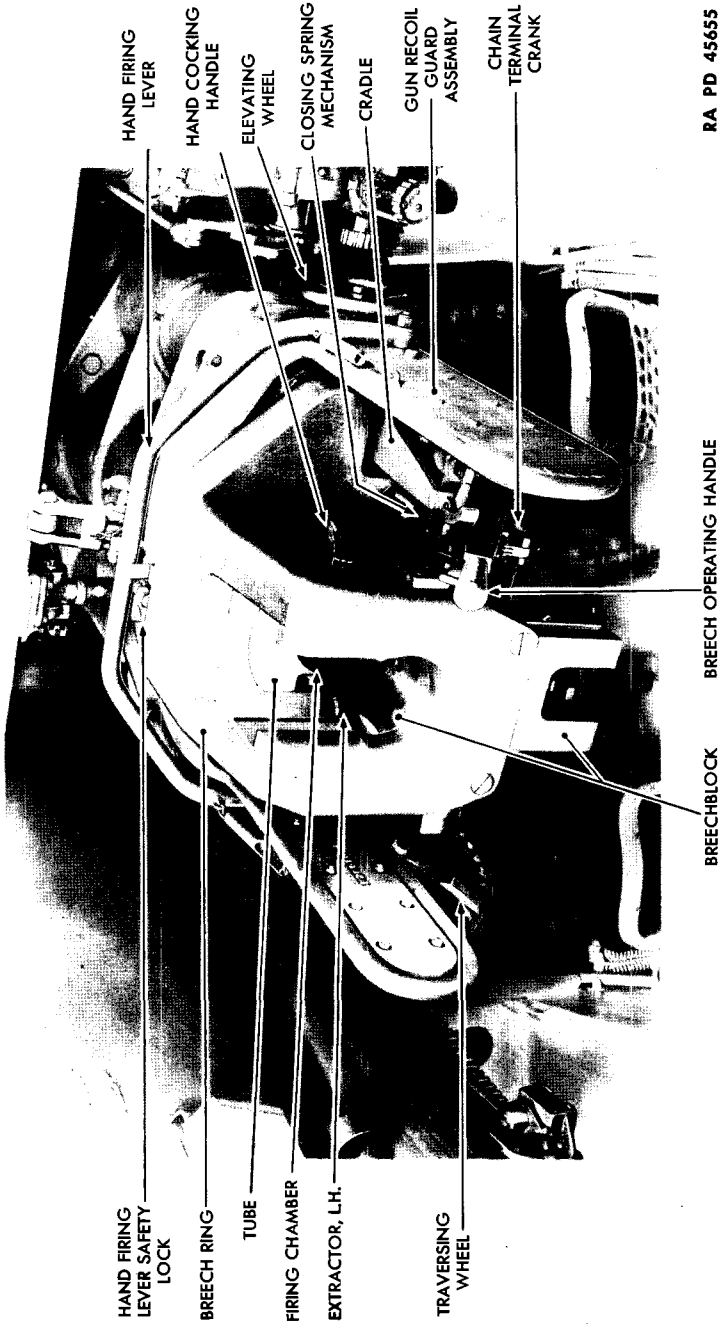
(2) The breech is usually automatically opened by the action of the operating crank ejector cam (fig. 107) during counterrecoil. However, the breech may be opened or closed manually by using the breech operating handle.

#### b. Automatic Opening of Breech.

(1) After a round has been fired, the gun recoils in the cradle. The counterrecoil springs return the gun to battery position.

(2) As the gun (fig. 107) slides forward, a projecting lug on the

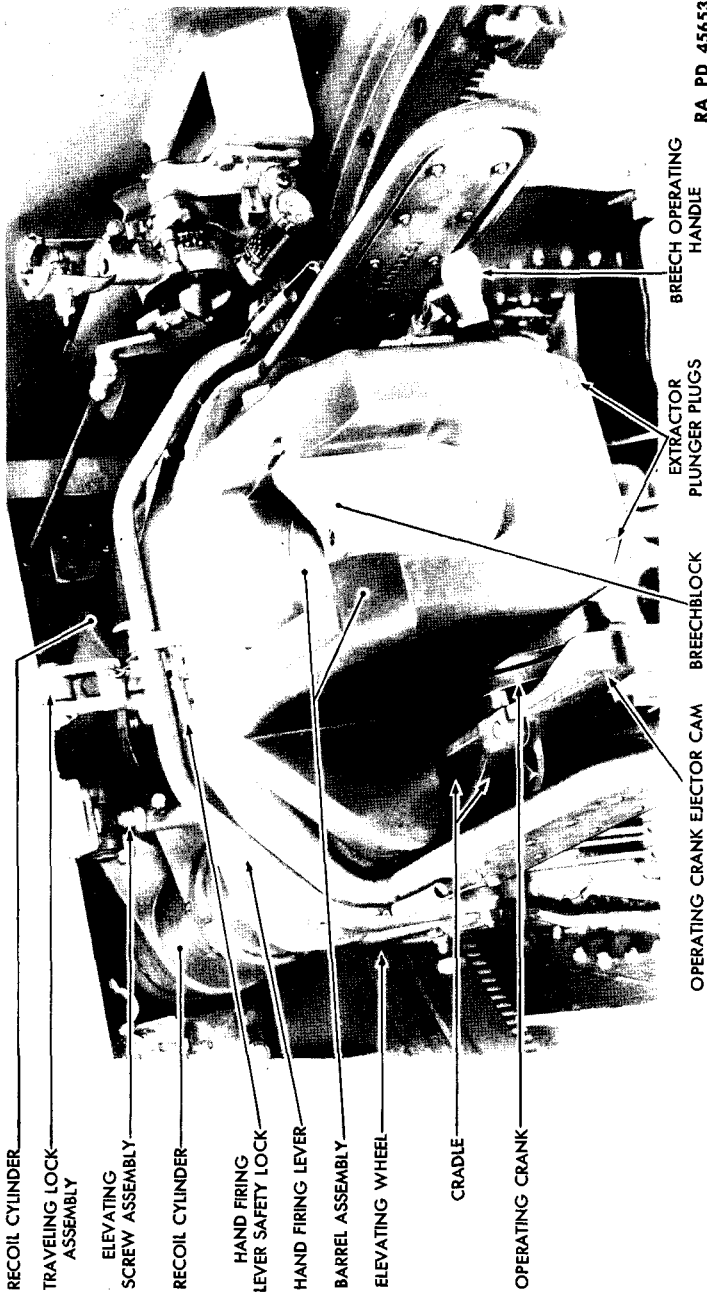
3-INCH GUN MOTOR CARRIAGE M10A1



RA PD 45655

Figure 106 — Right Quarter View of Breech End of Gun

DESCRIPTION AND FUNCTIONING OF GUN



RA PD 45653

Figure 107 — Left Quarter View of Breech End of Gun



3-INCH GUN MOTOR CARRIAGE M10A1

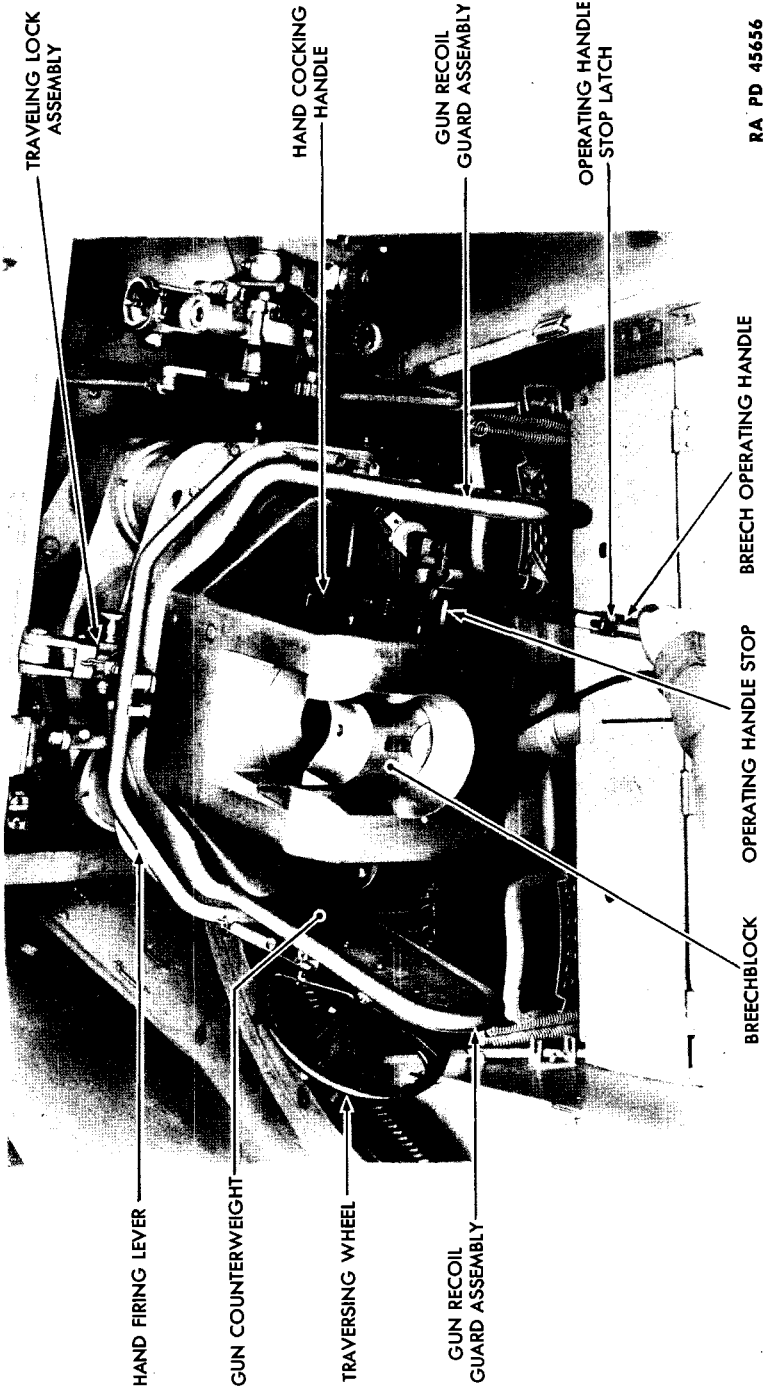
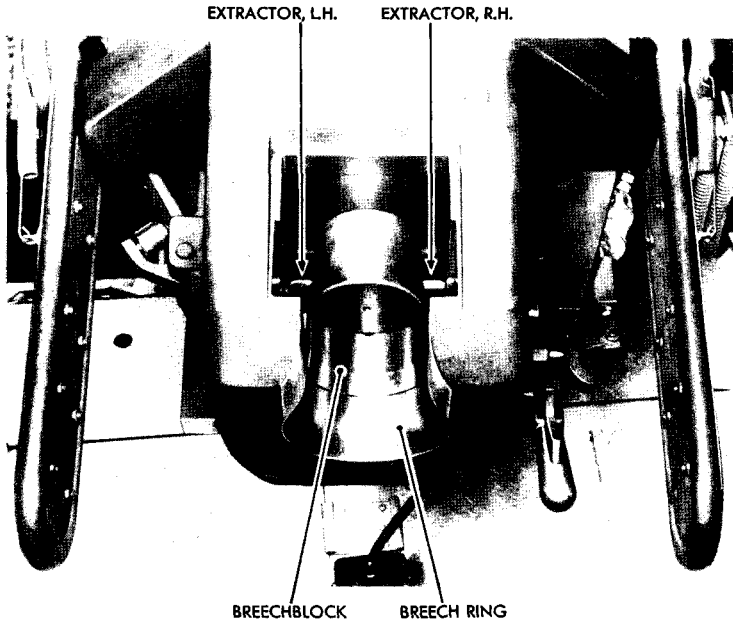


Figure 108—Manually Opening the Breech

DESCRIPTION AND FUNCTIONING OF GUN



RA PD 45666

**Figure 109—Closing the Breech by Loading a Round**

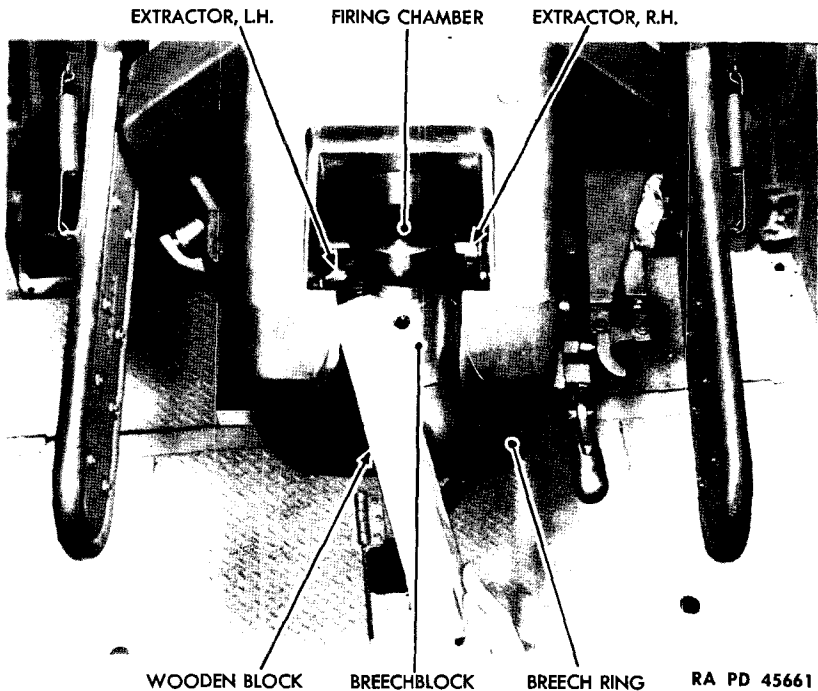
operating crank contacts an operating crank ejector cam on the cradle, and the operating crank is rotated rearward. The operating crank transmits the rearward motion through the breech operating shaft to the breechblock operating crank, whose arm swings rearward and downward, thereby causing the cross heads (on breechblock operating crank) to slide in the T-slot of the breechblock and to lower the breechblock.

(3) The rotation of the breech operating shaft also rotates the chain terminal crank rearward, thereby drawing the closing spring piston rearward and compressing the closing spring.

(4) As the breechblock moves downward, the inner trunnions on the two extractors slide in grooves cut in the sides of the breechblock (figs. 98 and 99). As the cartridge case is uncovered, the forward curve of the grooves cut in the breechblock forces the inner trunnions on the extractors forward. The extractors roll on the front face of the breech recess, and the lips of the extractors (on upper inner edge) first engage the rim of the cartridge case, then are forced rearward to draw the cartridge case out of the firing chamber, and eject it from the breech.

(5) As soon as the breechblock reaches its full open position, the

3-INCH GUN MOTOR CARRIAGE M10A1



**Figure 110—Manually Closing Breech—Wood Block**

breechblock is stopped by the contact of the breechblock operating crank with a stop surface on the bottom of the breech ring. The extractor plungers now force the outer trunnions of the two extractors forward, forcing the inner trunnion of the extractors to follow the cam grooves cut in the sides of the breechblock until the flat surfaces of the inner trunnions are seated on the flat surfaces at the top of the extractor cam grooves in the breechblock. The breechblock is now locked in an open position.

**c. Manual Opening of Breech (fig. 108).**

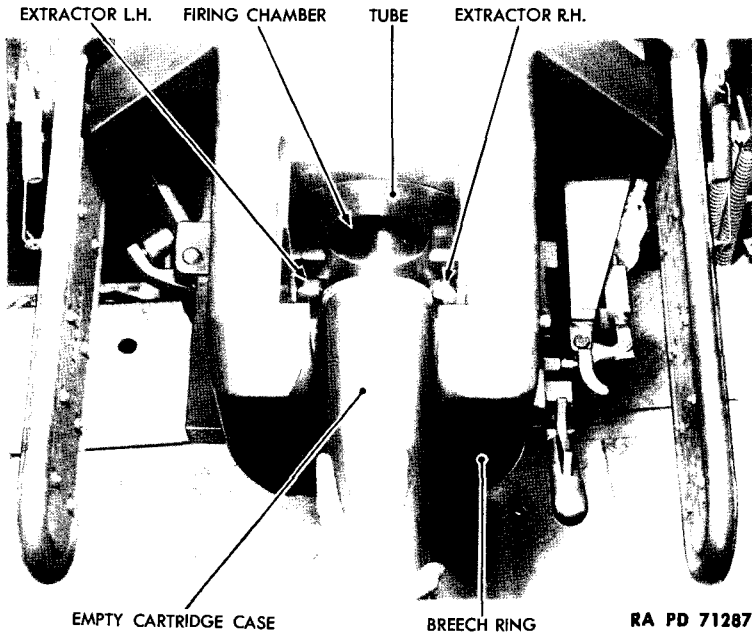
(1) Unlatch breech operating handle from operating handle stop by grasping lever so that operating handle stop latch is lifted clear of the stop.

(2) Push breech operating handle down until a distinct click can be heard; then, lift breech operating handle up and latch it on the operating handle stop.

**d. Closing Breech by Loading (fig. 109).**

(1) Insertion of a round into the firing chamber with sufficient force to push extractors forward unlocks the breechblock. **CAUTION:** Do not allow the fingers or hands to enter the breech recess. Failure to observe this may result in injury. Round must be inserted with a

## DESCRIPTION AND FUNCTIONING OF GUN



**Figure 111—Manually Closing Breech—Cartridge Case**

forward and upward movement of the arm using the palm of the hand on the base of the round in order to insure that arm is above and clear of the breech when the breech closes.

(2) As the round completes its entry into the firing chamber, the rim of the cartridge case strikes the lips of the extractors. The inner trunnions of the extractors are forced off the flats of the breechblock and into the grooves cut in the breechblock, thus releasing the breechblock from its locked position. The action of the compressed closing spring raises the breechblock to its closed or firing position.

(3) The closing spring being fastened to the chain terminal crank causes the chain terminal crank to turn the breech operating shaft (crank being on the shaft). The breechblock operating crank also turns because it is also on the breech operating shaft. These moving parts come to rest when the breechblock cross heads on the breechblock operating crank contact the rear face of the tube.

(4) As the breechblock rises, a bevel on the upper front face of the breechblock drives the round into the firing chamber. A forward movement is also imparted to the round by slightly inclined guides in the breechblock, and this forward movement completes the seating of the round.

**3-INCH GUN MOTOR CARRIAGE M10A1**

**e. Closing Breech Without Loading.**

**NOTE:** Do not use the fingers to press on extractors as possible injury may result.

(1) When it is desired to close a breech without inserting a round in the firing chamber, it can be accomplished with either a wood block (fig. 110) (about 2 x 4 x 12 in.) or with an empty cartridge case (fig. 111).

(2) Press on either one of the two extractors with a wood block until the extractor is pushed forward into its unlocked position; then press the opposite extractor forward until it is in its unlocked position, and the breechblock will fly upward.

Section XXIV

DESCRIPTON AND FUNCTIONING OF MOUNT

	Paragraph
General .....	149
Cradle .....	150
Elevating mechanism .....	151
Recoil mechanism .....	152
Gun recoil guard assembly .....	153
Mechanical firing mechanism .....	154
Electrical firing circuit .....	155
Cam ejector mechanism .....	156

149. GENERAL.

a. The mount assembly consists of a cradle with elevating mechanism and two recoil cylinders, mechanical firing mechanism, electrical firing circuit, and operating crank ejector mechanism.

b. The mount assembly rests on trunnions in the turret which is mounted on the Gun Motor Carriages M10 and M10A1.

150. CRADLE (fig. 112).

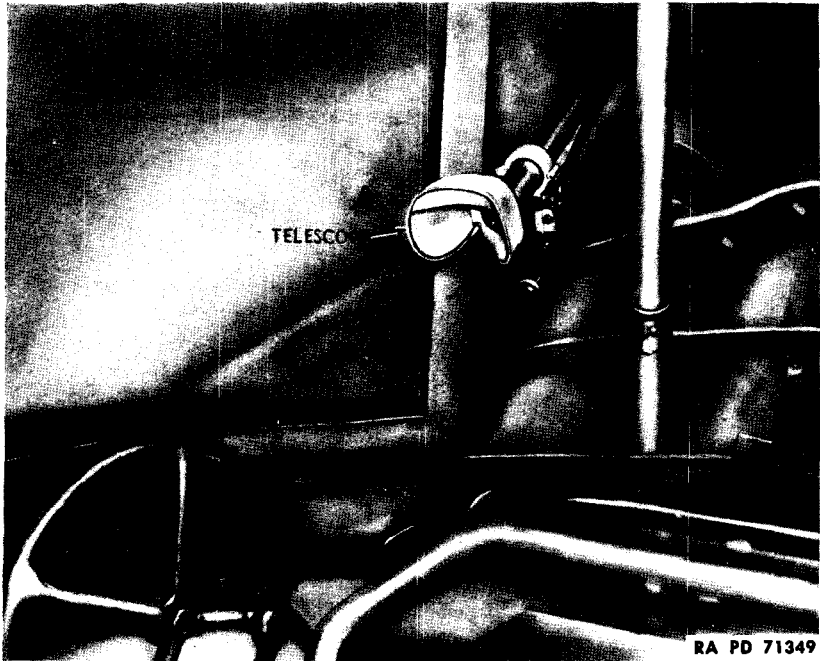
a. The cradle has two bored sections for two recoil cylinders. On the front of these bored sections are two keys, which are welded in place. These keys fit into keyways in the recoil cylinders in order to properly locate the recoil cylinders.

b. The gun shield forms the front of the turret. It has the telescope shutter on the outside with the telescope shutter handle on the inside, thus permitting the shutter to be operated from inside the turret. A cylindrical steel section ending in a machined flange is welded to the center of the inside of the gun shield and the tube passes through this cylindrical section. The machined flange is separated from the cradle by a spacer and the gun shield is then bolted through the spacer to the cradle. The gun shield has two arms which bolt to trunnions located inside the forward end of the turret (fig. 112).

c. The function of the mount is to provide stability and alinement for the gun during recoil and counterrecoil after firing and also to provide readily accessible means for elevating the gun during firing.

d. A large centrally bored section in the cradle contains bronze liners and is the barrel support. The finished and ground section of the barrel slides in the bronze liners during recoil and counterrecoil. Lubrication fittings on the cradle assure lubrication of the ground section of the barrel; and a wiper with retainer keeps excess lubricant and foreign matter out of the bronze liners and off the ground section of the barrel.

3-INCH GUN MOTOR CARRIAGE M10A1



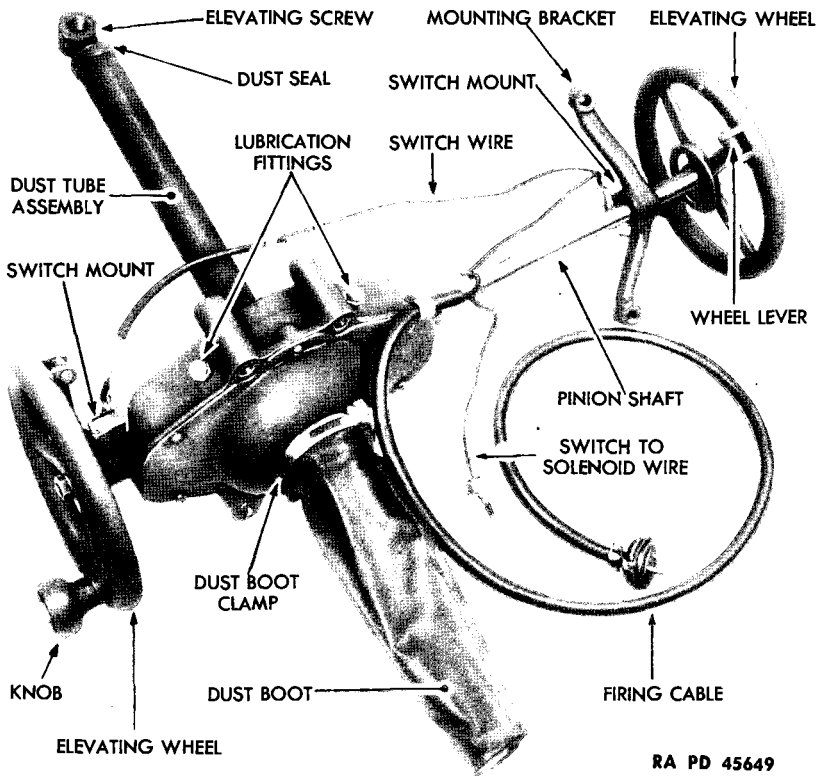
**Figure 112—Mount Assembly**

e. A lug at the top and rear of the cradle is bored to provide a means of locking the gun in its traveling position. The barrel is toward the rear, resting in its support, when traveling (fig. 97).

f. The recoil guard assembly is bolted to the rear of the cradle, and consists of a recoil guard assembly and a hand firing bar assembly. The recoil guard assembly is composed of a right and left recoil guard welded together. To these recoil guards is fastened the balancing weights and one end of the two coil springs used to hold the hand firing lever forward (in neutral position). A swivel-type lock for the hand firing lever is mounted on top of the recoil guard assembly to lock the lever in its neutral position. An adjusting screw with stop is bolted to the top of the recoil guard assembly for the hand firing lever. The hand firing lever is bolted to the right and left recoil guards and swivels in brackets bolted to the guards. The function of the recoil guards is to provide protection for the gun crew during recoil.

g. The elevating mechanism is bolted to the under side of the cradle. The mechanical firing mechanism, together with the electrical firing mechanism, is assembled on the right side of cradle. The operating crank ejector mechanism is mounted on the left side of the cradle.

**DESCRIPTION AND FUNCTIONING OF MOUNT**



**Figure 113—Elevating Mechanism**

h. The telescope mount is attached to a bracket which is welded on the turret and is connected to the cradle trunnion by means of an adjustable rod. The telescope is mounted on the cradle at the left side of the gun and just to the rear of the gun shield. The opening through the gun shield for the telescope has a heavy protective shutter which is operated by a handle from inside the turret.

**151. ELEVATING MECHANISM.**

**a. General (fig. 113).**

(1) The elevating mechanism consists of a centrally located gear to which is pinned an internally threaded elevating nut that operates an externally threaded elevating screw. Turning either the right or left elevating handwheel revolves pinions that mesh with the elevating gear. The elevating gear is keyed on the elevating nut, and the nut being threaded internally, operates the externally threaded elevating screw.

(2) The elevating mechanism has the electrical firing wires and switches attached to it.



**3-INCH GUN MOTOR CARRIAGE M10A1**

**152. RECOIL MECHANISM.**

**a. General.**

(1) The functions of the recoil mechanisms are to control and limit the recoil of the gun caused by firing, to return the gun to battery (counterrecoil), and to gradually reduce the shock of the gun as it returns finally into battery.

(2) There are two recoil cylinders, one on each side of the gun. These two recoil cylinders are held and located in the cradle by two keys that are welded on the cradle. Two recoil piston rods are screwed into the breech ring and then locked to the breech ring by socket head setscrews that push copper plugs into the threads of the recoil piston rods. Both recoil cylinders contain pistons which are spring operated. The cylinders are kept filled with proper amount of heavy recoil oil.

**b. Recoil Cylinders.**

(1) The front end of each recoil cylinder has a recoil cylinder purging plug which both retains and locates the recoil cylinder sleeve. The counterrecoil buffer is located at this end of the sleeve.

(2) The rear end of each recoil cylinder has a nut for holding the recoil cylinder to the breech ring. The plug for filling the recoil mechanism with recoil oil is at this end (fig. 114).

**c. Recoil Mechanism Action on Recoil.**

(1) When in battery position, the recoil cylinder pistons are at the forward end of the recoil cylinder. Immediately upon firing, the recoil of the barrel begins and because the recoil cylinder pistons are fastened to the breech ring, they start backward along with the barrel.

(2) The recoil oil in the recoil cylinder is displaced through orifices, and the counterrecoil inner and outer springs are compressed. The recoil cylinder piston ceases its travel on recoil, and the compressed counterrecoil inner and outer springs exert their pressure on the piston, thereby starting the piston forward on counterrecoil (toward battery position).

**d. Recoil Mechanism Action on Counterrecoil.**

(1) Counterrecoil buffer mechanism is fastened to the front end of the recoil cylinder and is the means of cushioning the last few inches of counterrecoil just before the barrel reaches battery position.

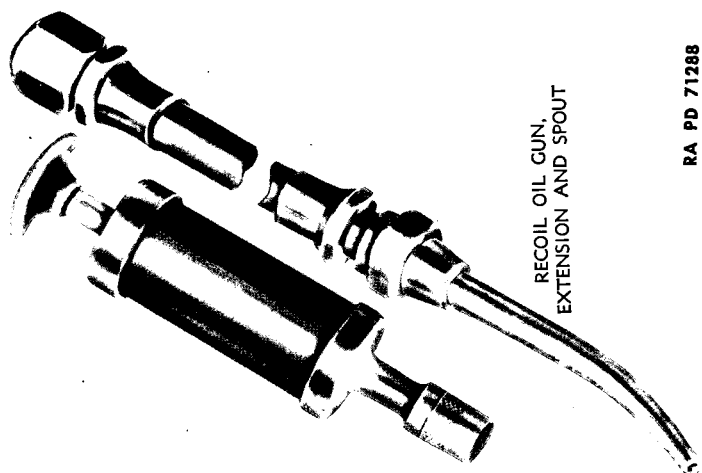
(2) The counterrecoil buffer fits inside the piston rod, and by displacing the recoil oil inside the piston rod, allows the gun to return to battery without shock.

**153. GUN RECOIL GUARD ASSEMBLY.**

**a. General (fig. 115)**

(1) The gun recoil guard assembly consists of an arm on each side of the breech which extends back from the cradle to beyond the end

DESCRIPTION AND FUNCTIONING OF MOUNT



RECOIL OIL GUN,  
EXTENSION AND SPOUT

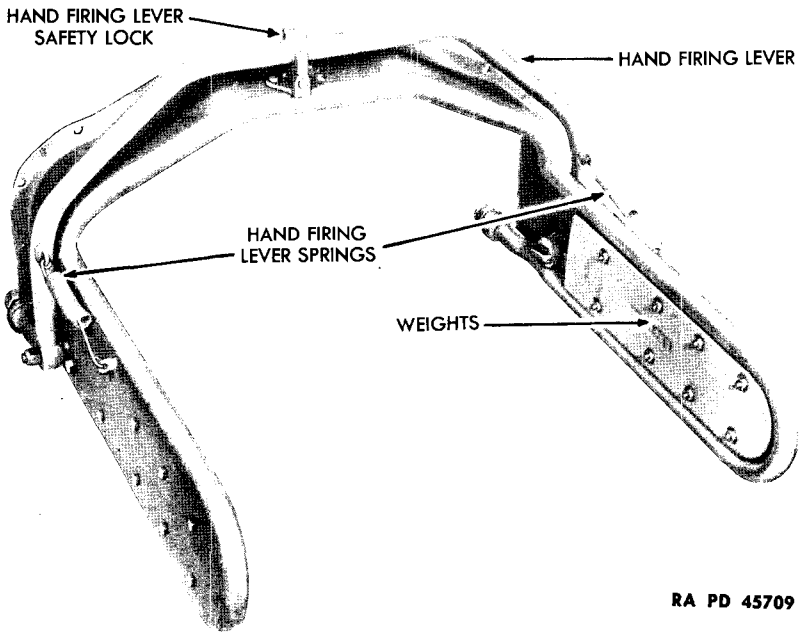
RA PD 71288



OIL FILLING HOLE

Figure 114—Filling Recoil Mechanism

**3-INCH GUN MOTOR CARRIAGE M10A1**



RA PD 45709

**Figure 115—Gun Recoil Guard Assembly**

of the breech ring (fig. 106). The hand firing lever extends from one side of the breech to the other and is bolted to the gun recoil guard assembly. The hand firing safety lock is bolted to the top of the gun recoil guard assembly. Weights to balance the gun are bolted to the gun recoil guards.

(2) The function of the gun recoil guards is to prevent injury to the gun crew during recoil and counterrecoil. The hand firing lever permits the round to be fired by hand. The hand firing safety lock secures the hand firing lever in locked position. The weights to the gun recoil guards balance the gun assembly to permit easy elevation and depression.

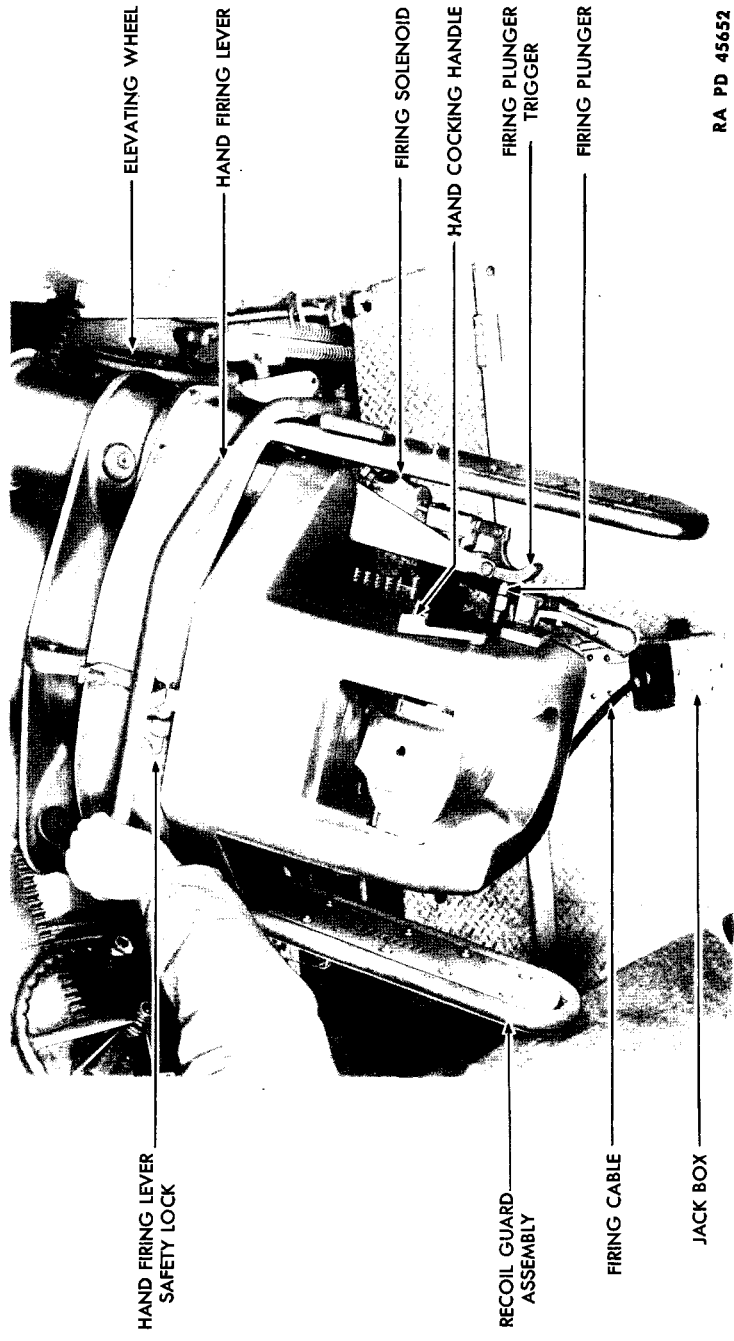
**154. MECHANICAL FIRING MECHANISM.**

**a. General.**

(1) The firing mechanism consists of a mechanical firing mechanism that is operated either by the electrical firing circuit or by the hand firing lever. The function of the mechanical firing mechanism is to provide a means for moving the sear transversely, in order to disengage the sear from the firing pin guide, thereby permitting the firing pin to strike the cartridge primer.

(2) The mechanical firing mechanism consists of a trigger con-

DESCRIPTION AND FUNCTIONING OF MOUNT



RA PD 45652

Figure 116—Hand Firing the Gun

### **3-INCH GUN MOTOR CARRIAGE M10A1**

nected to a firing rod and a hand firing lever that is connected to the solenoid plunger.

#### **b. Action of Mechanical Firing Mechanism (fig. 116).**

(1) A firing solenoid, mounted on the right side of the cradle, has a spring-operated plunger extending through the solenoid. The solenoid plunger can be operated electrically or manually by the hand firing lever, the action in either case being to move the solenoid plunger to the rear. The firing plunger trigger is rotated by the solenoid plunger and pushes the firing plunger inward to move the sear away from the percussion mechanism, thereby releasing the firing pin to fire the round.

#### **c. Manual Firing (fig. 116).**

(1) The hand firing lever has a solenoid lever attached to its right end, which contacts the solenoid plunger. When the hand firing lever is pushed forward, the solenoid lever pushes the solenoid plunger forward causing the firing plunger trigger to push the firing plunger inward into the breech ring. The lug on the sear (which has been holding the percussion mechanism in a cocked position) is moved away from the percussion mechanism, and the firing pin is released to fire the round.

(2) The hand firing lever can be locked in a neutral position by means of the hand firing lever safety lock. The forward movement of the hand firing lever, in order to fully release the percussion mechanism, can be adjusted by means of the hand firing lever adjusting screw (fig. 112).

### **155. ELECTRICAL FIRING CIRCUIT (fig. 117).**

a. Current for electrically firing the gun is obtained by inserting firing cable into jack box (fig. 116), and actual firing of the round is accomplished by pressing the firing plunger which is in the knob of both elevating wheels. The pressing of the firing plunger energizes the firing solenoid, causing the same mechanical action as described for manual firing.

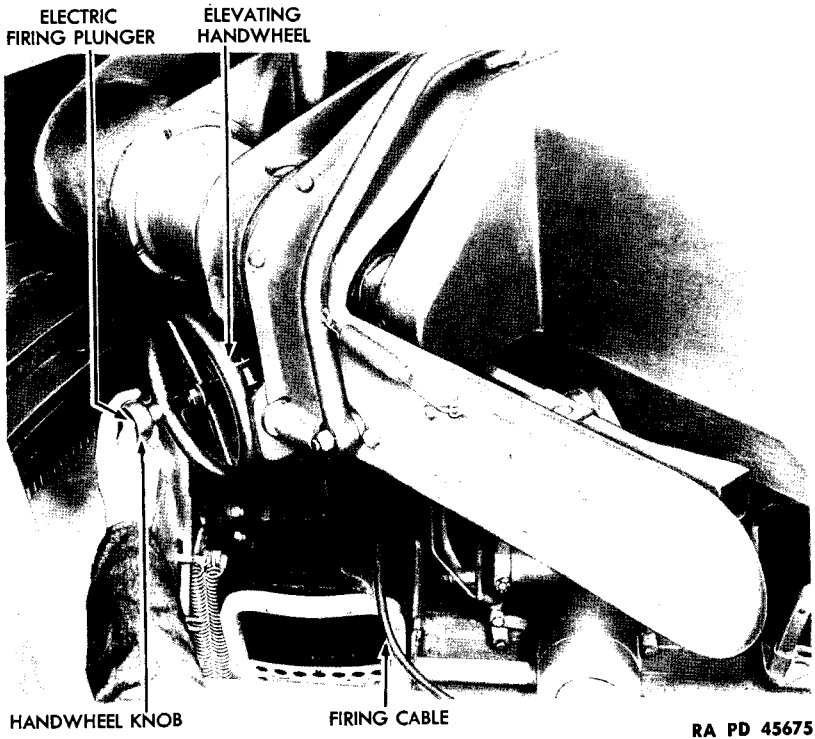
b. The electric wiring necessary is firing cable, switch wire, and switch-to-solenoid wire. All wiring is attached to the elevating mechanism (fig. 113).

### **156. CAM EJECTOR MECHANISM.**

#### **a. General.**

(1) The cam ejector mechanism consists of an ejector cam which is mounted on a bracket that extends out from left rear end of cradle. An ejector cam pin holds the cam to the cradle and two ejector cam screws secure the cam to the cam pin.

**DESCRIPTION AND FUNCTIONING OF MOUNT**



**Figure 117—Electrically Firing the Gun**

(2) The inside of the ejector cam has a sloped (cam) surface on which the breech operating crank operates. The front end of the ejector cam has an offset lug which contacts a spring-operated retainer to hold the cam in contact with the breech operating crank.

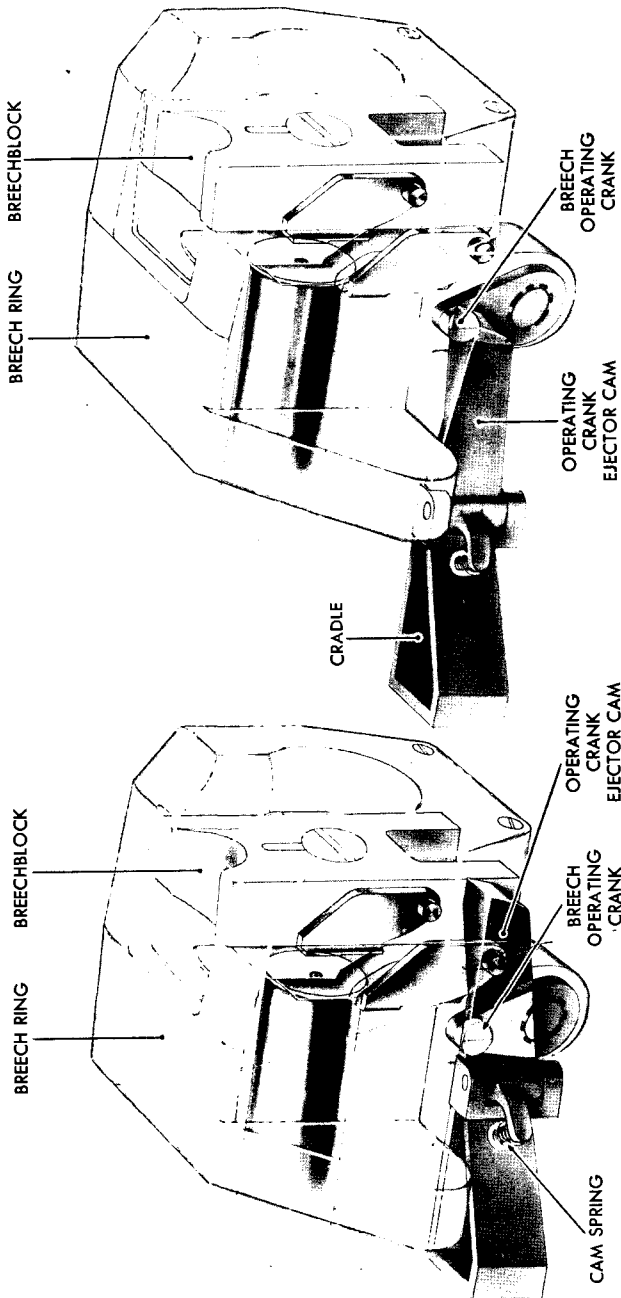
**b. Firing Position (fig. 118).** The breech operating crank rests inside of ejector cam when the operating crank and ejector mechanism are in firing position. The ejector cam spring retainer is maintaining pressure on the ejector cam, keeping the cam in contact with the breech operating crank.

**c. Recoil Position (fig. 118).**

(1) The breech operating crank, being attached to the breech operating shaft, recoils and counterrecoils along with the tube and breech. The ejector cam being attached to the cradle remains stationary during recoil and counterrecoil.

(2) The breech operating crank is carried backward to ride up onto the ejector cam when recoil starts. The front end of the ejector cam is forced inward against the ejector cam spring retainer, and the ejector cam is pivoted outward on the operating crank ejector pin.

3-INCH GUN MOTOR CARRIAGE M10A1



FIRING POSITION

RECOIL POSITION

RA PD 46295

Figure 118—Portion of Cartridge Case Ejection Operation

DESCRIPTION AND FUNCTIONING OF MOUNT

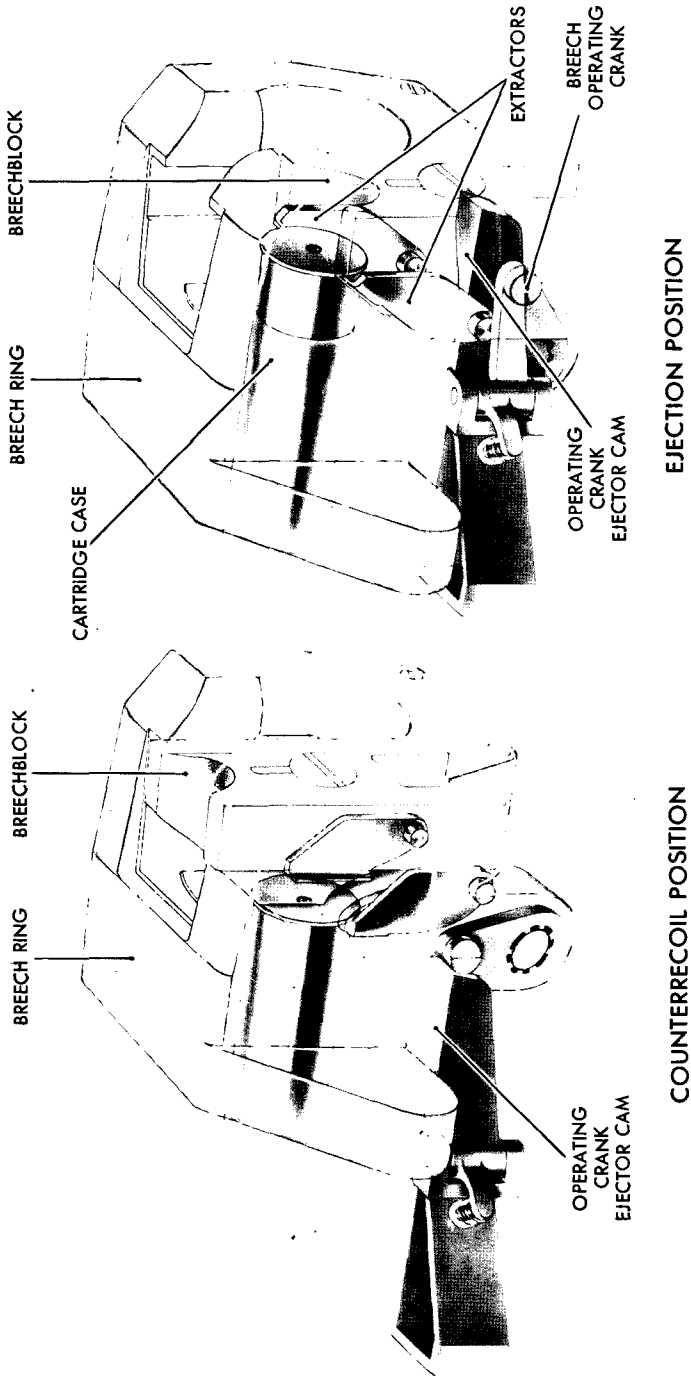


Figure 119—Portion of Cartridge Case Ejection Operation



**3-INCH GUN MOTOR CARRIAGE M10A1**

(3) As the recoil continues, the breech operating crank continues its ride up the sloped surface of the ejector cam and off the rear end of the ejector cam. The ejector cam spring retainer then pushes the ejector cam back into its normal (straight) position. The recoil continues for a short distance after the breech operating crank has ridden off the rear end of the ejector cam.

**d. Counterrecoil Position** (fig. 119). Counterrecoil starts with the breech operating crank off, and to the rear, of the ejector cam. As the barrel and breech near the finish of their counterrecoil, the breech operating crank strikes the rear end of the ejector cam. This causes the breech operating crank to rotate. The splined breech operating crank being on the splined breech operating shaft rotates the shaft, opening the breech and compressing the breech closing spring.

**e. Ejection Position** (fig. 119).

(1) The opening of the breech automatically ejects the fired cartridge case.

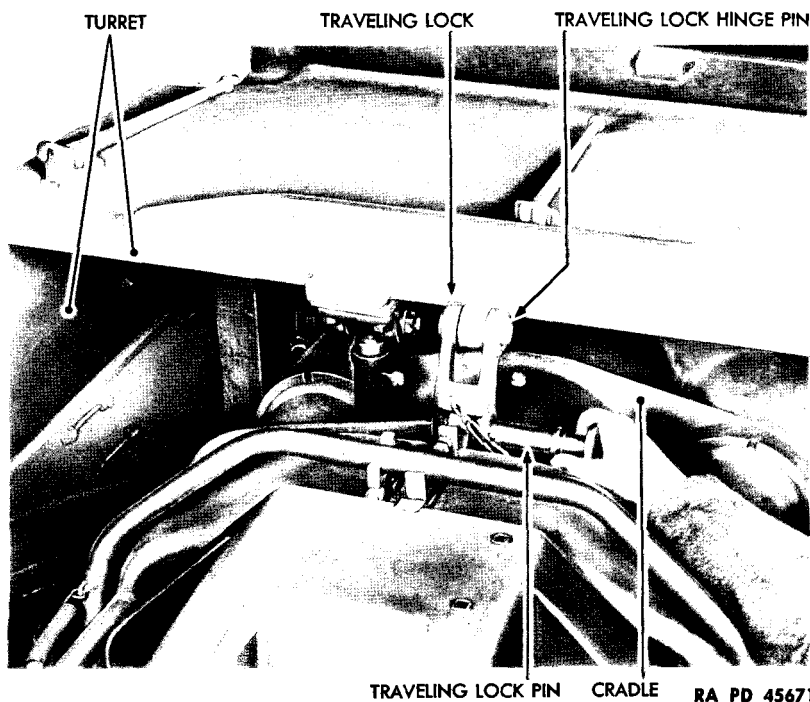
(2) As the counterrecoil continues, the breech operating crank turns off the end of the ejector cam and onto the bottom of the cam, then forward on the bottom of the cam; and as soon as a round is inserted into the firing chamber, the operating crank and ejector mechanism are again in firing position.

**Section XXV**  
**OPERATION OF GUN**

	Paragraph
Placing gun in firing position . . . . .	157
Traversing mechanism . . . . .	158
Elevating mechanism . . . . .	159
Loading . . . . .	160
Firing and precautions during firing . . . . .	161
Unloading . . . . .	162
Placing gun in traveling position . . . . .	163

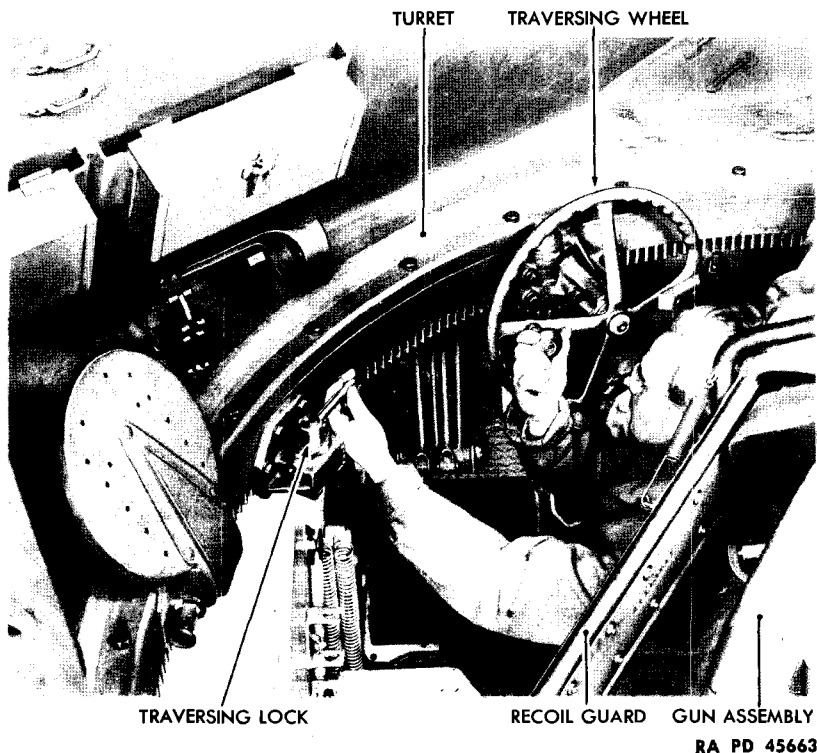
**157. PLACING GUN IN FIRING POSITION.**

- a. Remove breech cover, sight covers, and muzzle cover and stow them in the place assigned for them. Stow all equipment not needed for the operation of the gun.
- b. Pull traveling lock pin from traveling lock; then swing lock up under turret and install traveling lock pin through lock and turret lock bracket (fig. 120).
- c. There are two traversing locks, one on the left side to the rear



**Figure 120—Removing Traveling Lock Pin**

### 3-INCH GUN MOTOR CARRIAGE M10A1



**Figure 121—Traversing Wheel and Lock (Left Side)**

of the traversing wheel (fig. 121), and the other on the right side to the rear of the panoramic sight (fig. 122). Disengage these traversing mechanism locks.

d. Install Telescope M51 in mount on left side of gun at gun shield. Open telescope shutter by turning telescope shutter handle.

e. Elevate and traverse gun to make certain both mechanisms are working freely.

f. Manually open and inspect breech.

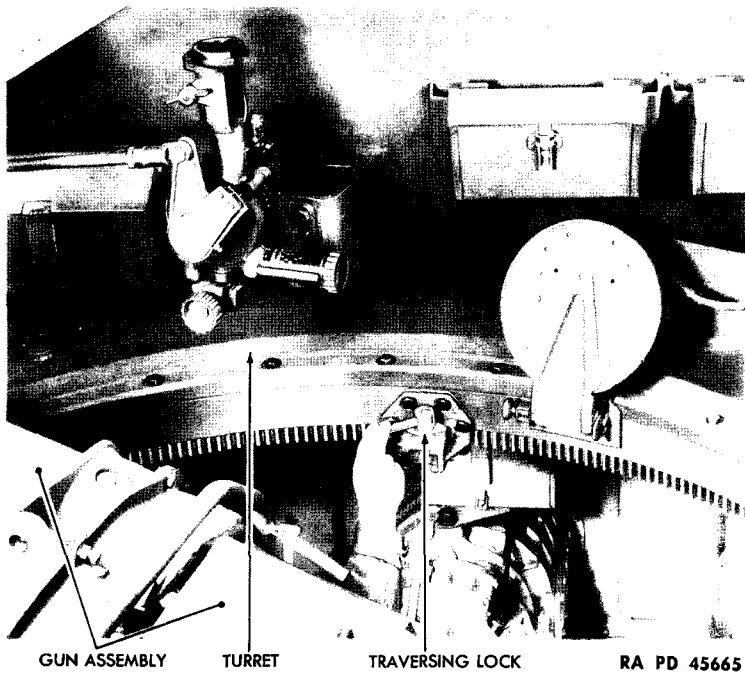
#### 158. TRAVERSING MECHANISM.

a. The traversing wheel is located on the left side of the turret at the hull (fig. 121). Traversing is accomplished by turning the traversing wheel either to the right or to the left. Complete traverse of 360 degrees can be obtained.

#### 159. ELEVATING MECHANISM.

a. The elevating mechanism is bolted to the cradle, and two wheels

OPERATION OF GUN



**Figure 122—Traversing Lock, Locked Position (Right Side)**

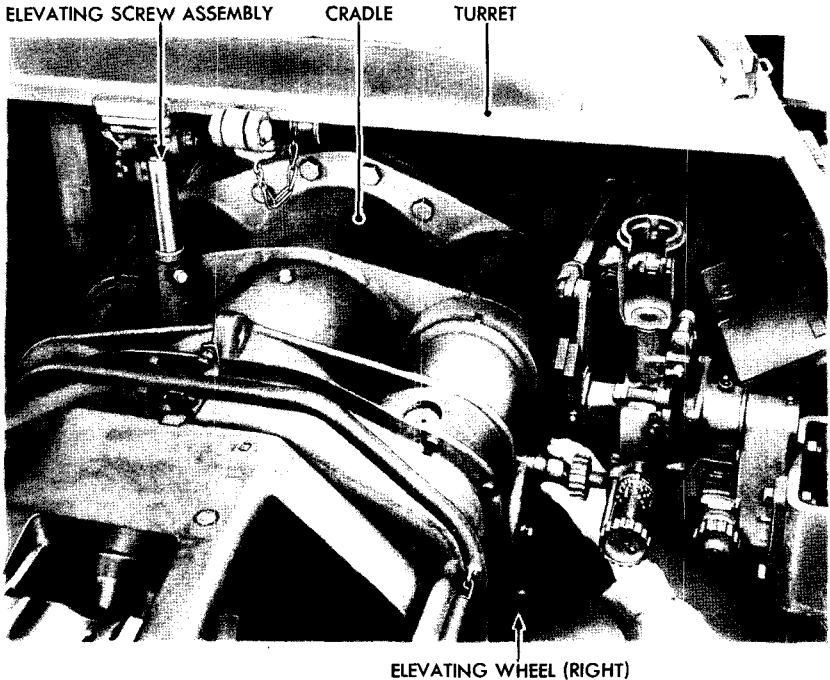
are provided for elevating the muzzle end of the gun. One wheel is on the right side of the gun and the other is on the left. Facing each wheel, elevation is accomplished by turning the wheel clockwise, and depression, by turning the wheel counterclockwise.

b. The electrical firing plunger is located in the center of the knob on both elevating wheels. The switch wire, switch-to-solenoid wire, and firing cable are located on the elevating mechanism underneath the cradle.

c. Hand cock the percussion mechanism by pushing down (hard) on hand cocking handle (fig. 124); then fire the gun by pressing on electrical firing plunger. If a distant click is not heard (caused by the release of the firing pin), make certain wire connections are tight.

d. Turn hand firing lever safety lock down (fig. 124) and repeat as in c above, by using hand firing lever. If hand firing lever is not to be used, turn hand firing lever safety lock up again to avoid accidental firing.

**3-INCH GUN MOTOR CARRIAGE M10A1**



RA PD 45657

**Figure 123—Elevating Wheel (Right)**

**160. LOADING.**

a. **Open Breech.** Manually open the breech by unlatching breech operating handle from operating handle stop and pushing handle down until distinct click can be heard; then lift and latch the handle on handle stop.

b. **To Load Gun.** The round must be inserted into the firing chamber with sufficient force to operate the extractors and close the breech.

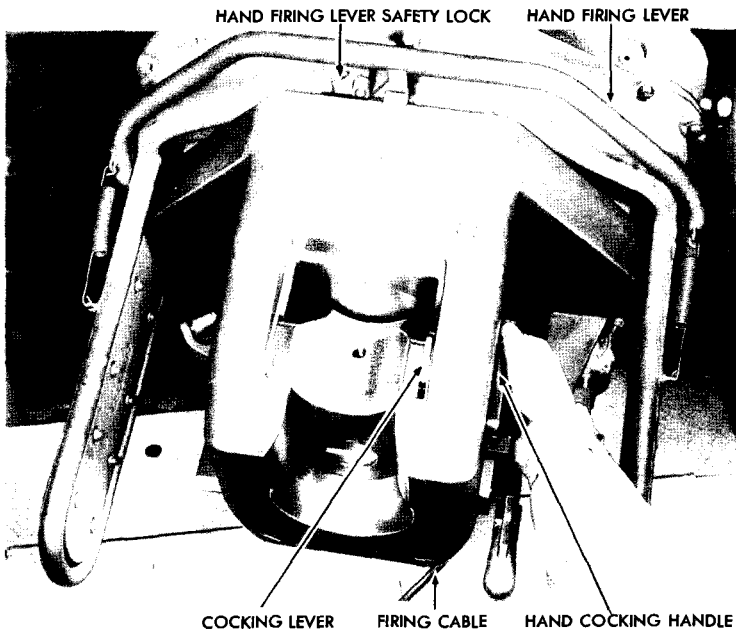
**161. FIRING AND PRECAUTIONS DURING FIRING.**

a. At the command "fire" the electrical firing plunger (fig. 117) on the right or the left elevating wheel can be pushed, or the hand firing lever pushed to fire the round (fig. 116).

b. The breech is opened and the fired cartridge case is ejected, automatically, by the action of recoil and counterrecoil. The fired cartridge case should be immediately removed from the vehicle.

c. The two recoil cylinders should be kept filled with the proper amount of recoil oil. If the gun returns to battery with shock, it is an indication that the recoil mechanisms require recoil oil.

## OPERATION OF GUN



RA PD 45673

**Figure 124—Cocking with Hand Cocking Handle**

d. The lubrication fitting on the top of the cradle (fig. 112) is for lubricating the tube during its slide on recoil and counterrecoil. The tube should be lubricated occasionally during firing.

e. Whenever the rate of fire permits, the bore should be examined for fouling. If present, use bore brush to remove loose particles.

f. When using equipment, make certain that it is placed where it will not interfere with the action of gun or crew.

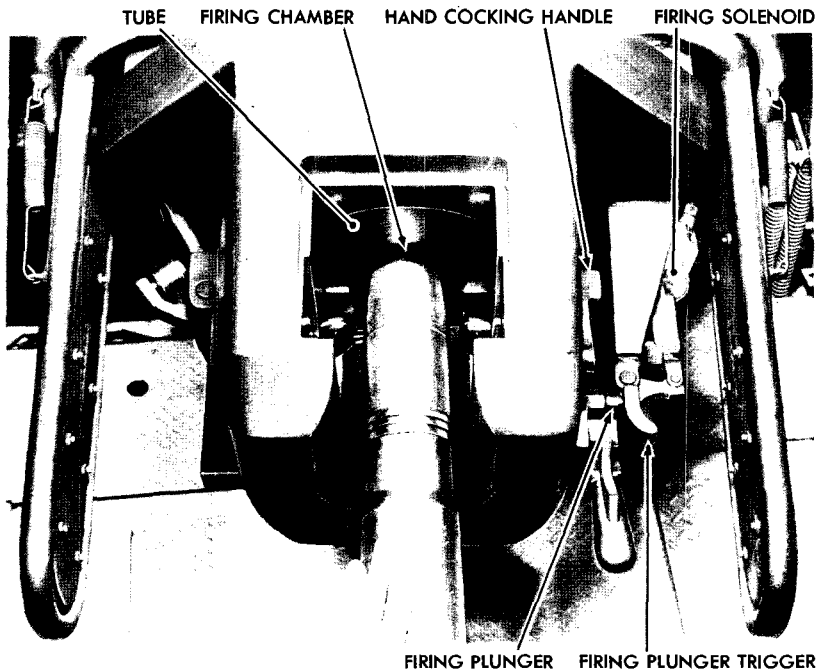
g. Do not stand or sit at the rear of gun during recoil and ejection.

h. If enemy shell bursts near weapon, make certain no damage has been done which might make continued firing dangerous.

### 162. UNLOADING.

a. There are times when it is necessary to unload the piece. Open the breech manually and catch the round as it is ejected. When a misfire occurs or an extractor breaks, it may be necessary to use the unloading rammer. **NOTE:** The rammer will be used to unload a live shell only under the commander's supervision and with extreme caution.

3-INCH GUN MOTOR CARRIAGE M10A1



RA PD 45651

**Figure 125—Loading the Gun**

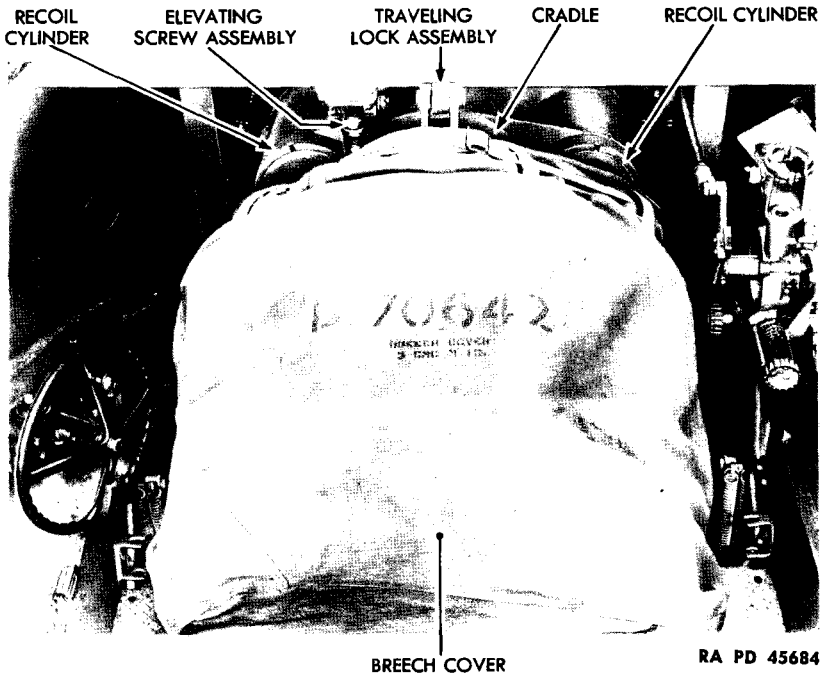
**163. PLACING GUN IN TRAVELING POSITION.**

a. Cover the telescope and remove it from its mount, and place it in the stowage case.

b. Turn traversing lock handles to the rear (figs. 121 and 122); then turn the traversing handwheel until the tube is over the gun rest (fig. 97). Turn elevating wheel counterclockwise (facing wheel) to depress tube and seat in gun rest.

**CAUTION:** Before traveling, inspect and make certain that *both* of the primary turret traversing locks are *securely* fastened. Visual inspection should be made of carriages equipped with screw type locks in order to insure positive engagement of *both* locks. The position of the handle will indicate proper engagement on carriages equipped with eccentric type locks. The traversing mechanism itself acts as an auxiliary turret brake. It is not strong enough, however, to lock the turret securely, particularly when traveling over rough terrain. Therefore, if *both* of the primary turret traversing locks are not securely engaged when traveling, the traversing mechanism will break, allowing the gun tube to swing around and cause serious injury to the personnel, or loss of life.

## OPERATION OF GUN



**Figure 126—Breech Covering in Traveling Position**

- c. Remove traveling lock pin from turret bracket and turn traveling lock down. Turn elevating wheel to aline hole in traveling lock with hole in cradle bracket, and insert traveling lock pin through traveling lock and cradle bracket (fig. 120).
- d. Install breech and muzzle covers.
- e. Remove machine gun lock pin from machine gun bracket. Turn machine gun lock handle up to its unlocked position. Cover cal. .50 machine gun; then remove gun and stow inside of turret.
- f. Fill two recoil cylinders with the proper amount of recoil oil.



3-INCH GUN MOTOR CARRIAGE M10A1

Section XXVI

LUBRICATION OF GUN AND MOUNT

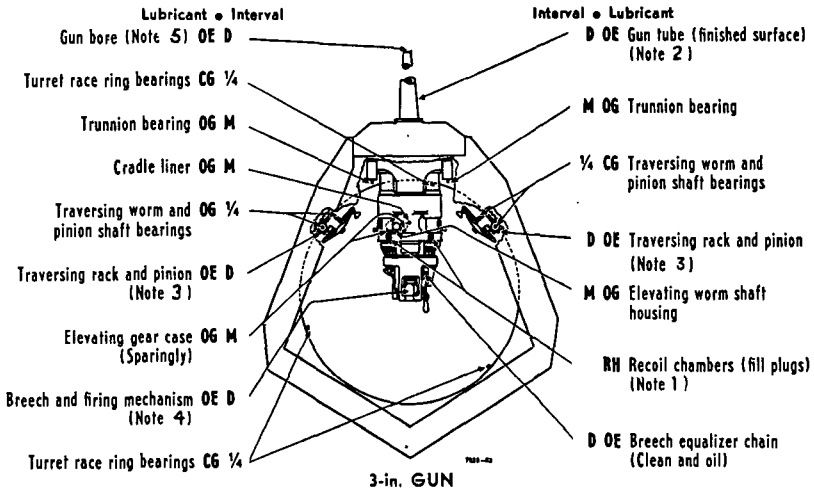
Introduction .....	164	Paragraph
Lubrication guide .....	165	
Points to be lubricated by ordnance maintenance personnel ..	166	
Special lubrication and service instructions .....	167	
Reports and records .....	168	

164. INTRODUCTION.

a. Lubrication is an essential part of preventive maintenance, determining to a great extent the serviceability of parts and assemblies.

165. LUBRICATION GUIDE.

a. General. Lubrication instructions for this materiel are consolidated in a lubrication guide (fig. 127). These specify the points to be lubricated, the periods of lubrication, and the lubricant to be used.



KEY

LUBRICANTS	
OE—OIL, engine SAE 30 (above +32°) SAE 10 (below +32°)	CG—GREASE, general purpose No. 1 (above +32°) No. 1 or No. 0 (+32° to +10°) No. 0 (below +10°)
OG—GREASE, O.D. No. 0 (above +32°) No. 00 (below +32°)	RH—OIL, recoil, heavy

INTERVALS
D—DAILY
W—WEEKLY
M—MONTHLY
1/4—500 MILES

RA PD 70661

Figure 127—Lubrication Guide

## LUBRICATION OF GUN AND MOUNT

In addition to the items on the guide, other small moving parts, such as hinges and latches, must be lubricated at frequent intervals.

**b. Supplies.** In the field it may not be possible to supply a complete assortment of lubricants called for by the lubrication guide to meet the recommendations. It will be necessary to make the best use of those available, subject to inspection by the officer concerned, in consultation with responsible ordnance personnel.

**c. Lubrication Notes.** The following notes apply to the lubrication guide (fig. 127). All note references in the guide itself are to the subparagraph below having the corresponding number:

(1) **RECOIL FLUID.** Refill with proper quantity and type of recoil oil.

(2) **GUN TUBE.** Daily and before firing, clean and oil exposed finished metal surface. Keep surface covered with thin film of OIL, engine, seasonal grade.

(3) **TRAVERSING RACK AND PINION.** Daily, clean and apply OIL, engine, seasonal grade.

(4) **BREECH AND FIRING MECHANISM.** Daily and before and after firing, clean and oil all moving parts and exposed metal surfaces with OIL, engine, seasonal grade. **CAUTION:** To insure easy breech operation and to avoid misfiring in cold weather, clean with SOLVENT, dry-cleaning, dry and lubricate with OIL, lubricating, for aircraft instruments and machine guns. To clean firing mechanism, remove and operate pin in SOLVENT, dry-cleaning.

(5) **GUN BORE.** Daily and after firing, clean and coat with OIL, engine, seasonal grade.

### 166. POINTS TO BE LUBRICATED BY ORDNANCE MAINTENANCE PERSONNEL.

- a. Elevating screw.
- b. Two cradle trunnion bearings.
- c. Elevating gear case (two places).
- d. Telescope mount.

### 167. SPECIAL LUBRICATION AND SERVICE INSTRUCTIONS.

**a. Fittings and Oilers.** Clean before applying lubricant. Where bearings can be seen, lubricate armament fittings until new grease is forced from the bearing. **CAUTION:** Lubricate fittings and oilers after washing. Never use high-pressure washing system for cleaning artillery materiel.

**b. Intervals.** The intervals indicated at points on lubrication

**3-INCH GUN MOTOR CARRIAGE M10A1**

guide are for normal service. For extreme conditions of service, rain, snow, heat, or dust, reduce intervals on guide by one-third or one-half or more, if conditions warrant.

**168. REPORTS AND RECORDS.**

**a. Reports.** If lubrication instructions are closely followed, proper lubricants used, and satisfactory results are not obtained, report to ordnance personnel.

**b. Records.** A complete record of lubrication servicing will be kept for the materiel.

Section XXVII

SIGHTING EQUIPMENT

	Paragraph
General .....	169
Telescope M51 .....	170
Periscope M6 .....	171
Gunner's quadrant M1 .....	172

169. GENERAL.

a. The sighting equipment for the 3-inch Gun Motor Carriage M10 consists of the Telescope M51, the Periscope M6, and the Gunner's Quadrant M1. Arrangement of the equipment is shown in figure 128.

b. The information in this chapter is not as complete or as accurate as will be in a future revision.

170. TELESCOPE M51.

a. The Telescope M51 is used for direct laying of the gun against moving targets when firing the 3-inch Armor Piercing Shell M62. Observing through the telescope, bring the image of the target to the point on the reticle representing the required range and deflection by rotating the traversing and elevating handwheels of the gun carriage.

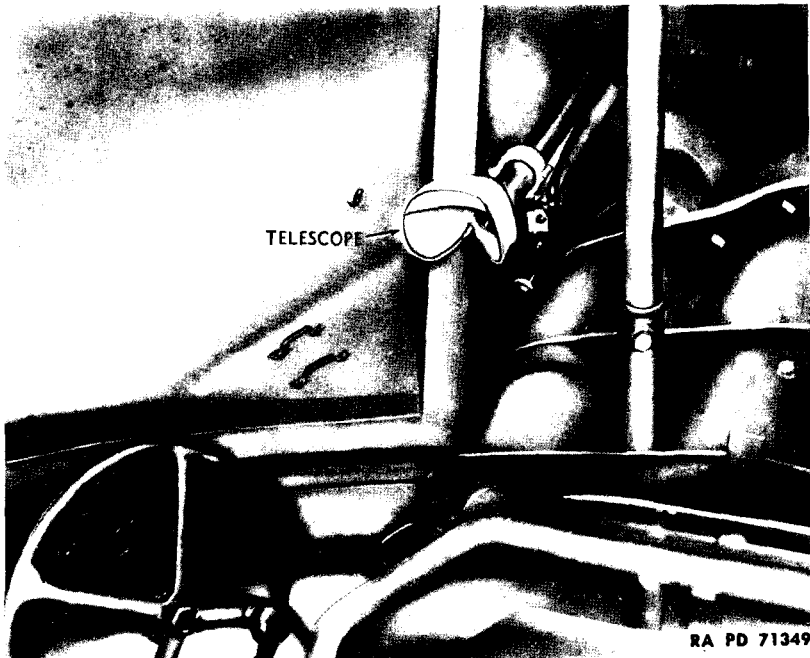


Figure 128—Arrangement of Telescope M51

3-INCH GUN MOTOR CARRIAGE M10A1

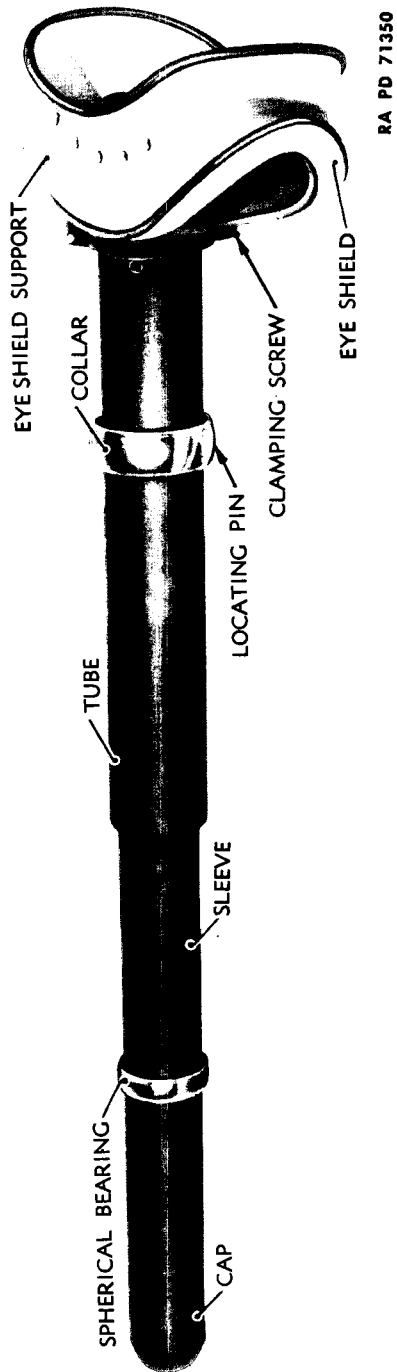
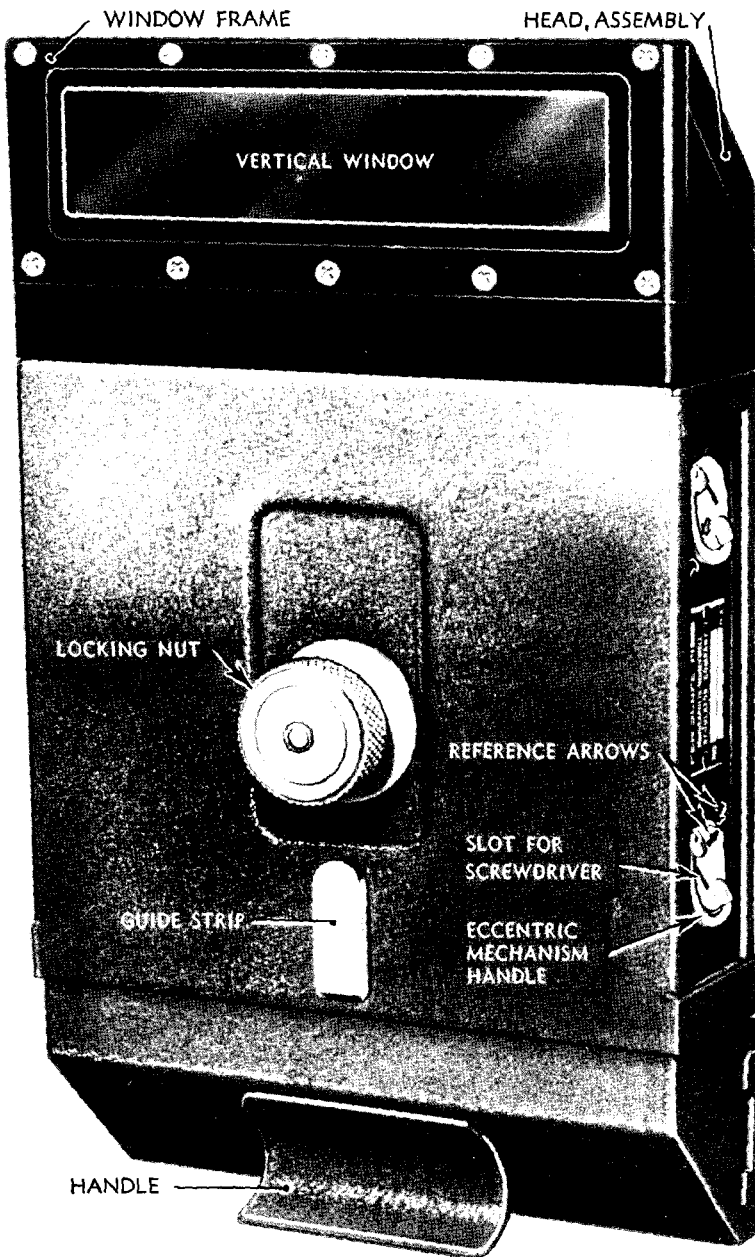


Figure 129 — Telescope M51

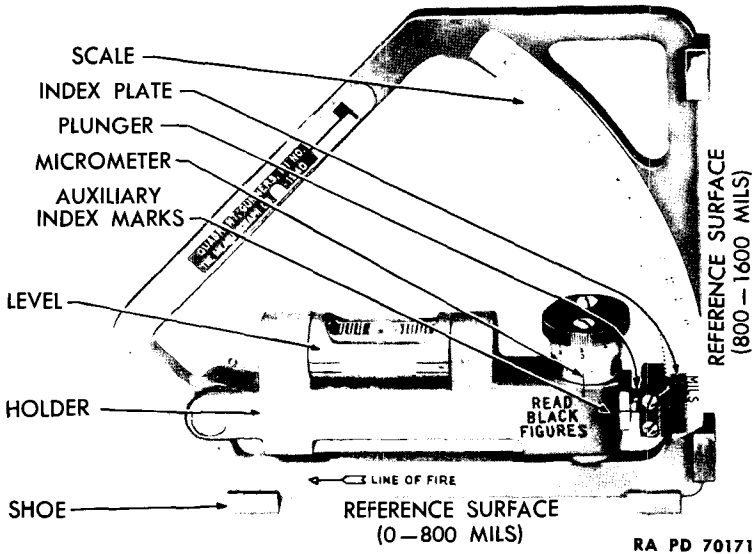
SIGHTING EQUIPMENT



RA PD 43058

Figure 130—Periscope M6  
261

3-INCH GUN MOTOR CARRIAGE M10A1



RA PD 70171

Figure 131—Gunner's Quadrant M1

171. PERISCOPE M6.

a. The Periscope M6 is used for observation and vision purposes only. The observer places his hands on the holder of the periscope to rotate and elevate or depress it until the desired panorama is brought into the field of view of the instrument.

172. GUNNER'S QUADRANT M1.

a. Elevation Angles.

(1) To measure elevation of the gun, place the proper reference surface (fig. 131) of the gunner's quadrant on the leveling pads of the gun, parallel to the bore, with the associated arrow pointing in the direction of fire. Set the "0" of the micrometer opposite its index with the auxiliary index marks matched.

(2) Disengage the plunger from the notches in the frame, lift the holder, and lower it slowly until the bubble is seen to pass through its central position. Allow the plunger to engage the notches, and rotate the micrometer knob until the bubble is centered with respect to the graduations on the level vial. Face the side of the quadrant which bears the arrow in use, and read the elevation indicated on the elevation scale and micrometer; read red or black figures according to the instructions engraved below the micrometer. Remove the quadrant from the gun before firing.

b. Depression Angles. To measure depression angles, proceed as in a above, with the arrow pointed in the reverse direction.

**Section XXVIII**

**AMMUNITION**

	<b>Paragraph</b>
General .....	173
Authorized ammunition .....	174
Stowage of ammunition .....	175
Field reports of accidents .....	176

**173. GENERAL.**

a. Ammunition for Carriage, motor, 3-in. gun M10, consists of:

- (1) Rounds for Gun, 3-in., M7.
- (2) Cartridges for Gun, machine, cal. .50, Browning, M2, heavy barrel.
- (3) Cartridges for Gun, submachine, cal. .45, Thompson, M1928A1.
- (4) Cartridges for Rifle, U. S., cal. .30, M1903 (w/Launcher, grenade, M1).
- (5) Cartridges for Carbine, cal. .30, M1.
- (6) Grenades.

b. Ammunition for Gun, 3-inch, M7, is issued in the form of fuzed complete rounds of fixed ammunition. The term "fixed" signifies that the propelling charge is not adjustable and that the round is loaded into the cannon as a unit. The round consists of a primer and propelling charge of loose powder grains contained in a cartridge case which is crimped rigidly to the fuzed projectile. A complete round includes all the ammunition components required to fire the weapon once.

**174. AUTHORIZED AMMUNITION.**

a. The ammunition authorized for use with the weapons mounted or carried on this motor carriage, and other ammunition carried on the vehicle, are listed in Table I below. It will be noted that the nomenclature (standard nomenclature) completely identifies the ammunition as to type and model.

**TABLE I—AUTHORIZED ROUNDS  
FOR GUN, 3-IN., M7**

**SERVICE AMMUNITION**

- Projectile, fixed, A. P. C., M62, w/Fuze, B. D., M66A1, and Tracer, 3-inch guns, M1918 (all models), M1, M3, M5, M6, and M7.
- Projectile, fixed, A. P. C., M62, w/Tracer, 3-inch guns, M1918 (all models), M1, M3, M5, M6, and M7.
- Shot, fixed, A. P., M79, w/Tracer, 3-inch guns, M1918 (all models), M1, M3, M5, M6, and M7.



**3-INCH GUN MOTOR CARRIAGE M10A1**

**SERVICE AMMUNITION—Cont'd**

Shell, fixed, H. E., M42, w/Fuze, P. D., M48, 3-inch (15-pdr.) gun, M1902MI, and 3-inch guns, M5, M6, and M7.<sup>1</sup>

Shell, fixed, H. E., M42A1, w/Fuze, P. D., M48, 3-inch (15-pdr.) gun, M1902MI, and 3-inch guns, M5, M6, and M7.<sup>1</sup>

Shell, fixed, H. E., M42A1, w/Fuze, P. D., M48A1, 3-inch (15-pdr.) gun, M1902MI, and 3-inch guns, M5, M6, and M7.<sup>2</sup>

**PRACTICE AMMUNITION**

Shot, fixed, T. P., M85, w/Tracer, 3-inch guns, M1918 (all models), M1, M3, M5, M6, and M7.

**DRILL AMMUNITION**

Cartridge, drill, M4A1, w/Fuze, dummy, 21-sec., M42A1, 3-inch guns, M1918 (all models), M1, M3, M5, M6, and M7, and 3-inch (15-pdr.) gun, M1902MI.

Cartridge, drill, M10, w/Fuze, dummy, 21-sec., M42A1, 3-inch guns, M1918 (all models), M1, M3, M5, M6, and M7, and 3-inch (15-pdr.) gun, M1902MI.

Cartridge, drill, M15, w/Fuze, dummy, M59, 3-inch guns, M1918 (all models), M1, M3, M5, M6, and M7, and 3-inch (15-pdr.) gun, M1902MI.

**BLANK AMMUNITION**

Ammunition, blank, 3-inch (15-pdr.) gun, M1902MI, and 3-inch guns, M1918 (all models), M1, M3, M5, M6, and M7.

**AMMUNITION FOR GUN, MACHINE, CAL. .50, BROWNING, M2, HEAVY BARREL**

**SERVICE AMMUNITION**

Cartridge, armor-piercing, cal. .50, M2.

Cartridge, ball, cal. .50, M2.

Cartridge, incendiary, cal. .30, M1.

Cartridge, tracer, cal. .50, M1.

**BLANK AMMUNITION**

Cartridge, blank, cal. .50, M1.

**DUMMY AMMUNITION**

Cartridge, dummy, cal. .50, M1.

Cartridge, dummy, cal. .50, M2.

**AMMUNITION FOR GUN, SUBMACHINE, CAL. .45, THOMPSON, M1928A1**

**SERVICE AMMUNITION**

Cartridge, ball, cal. .45, M1911.

**DUMMY AMMUNITION**

Cartridge, dummy, cal. .45, M1921.

<sup>1</sup>SQ and 0.05-second delay.

<sup>2</sup>SQ and 0.15-second delay.

AMMUNITION

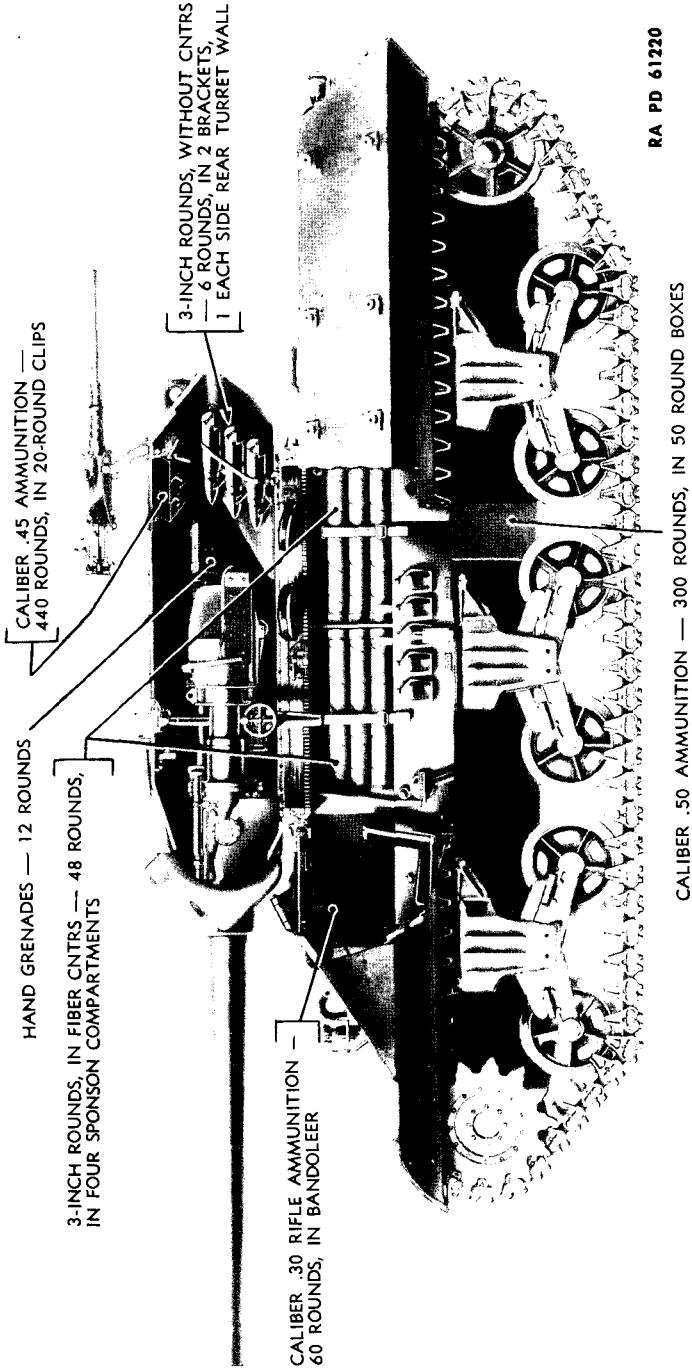
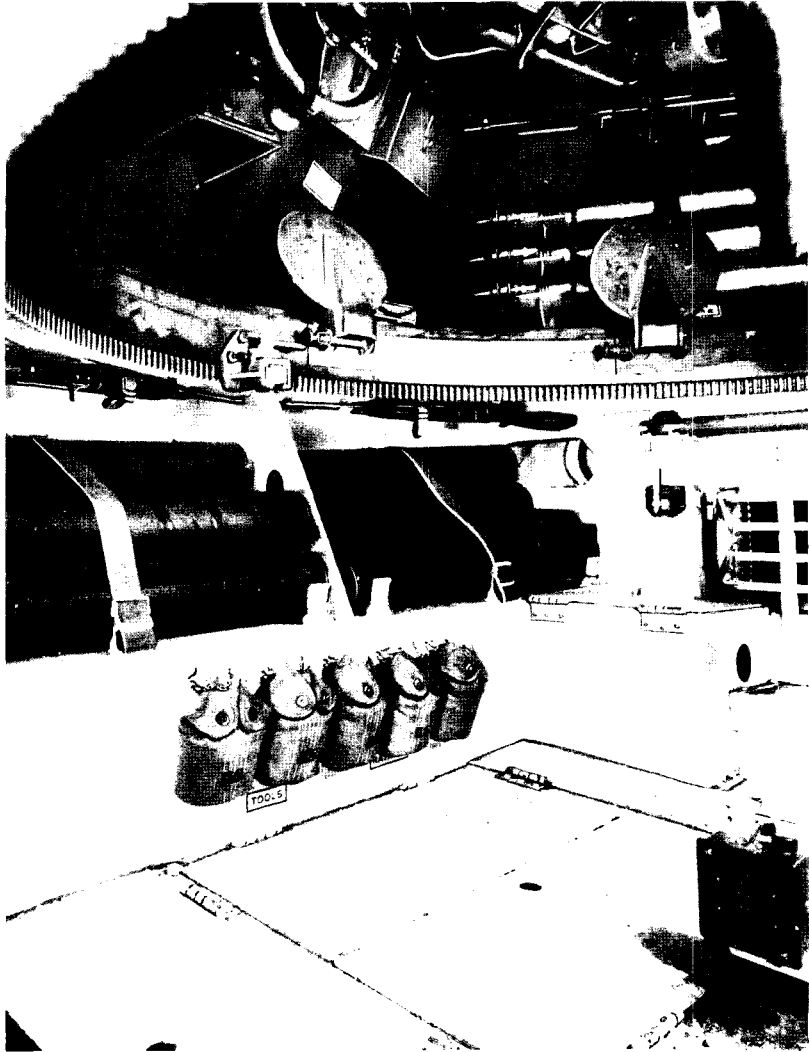


Figure 132—Ammunition Storage, 3-inch Gun Motor Carriage M10 and M10A1

**3-INCH GUN MOTOR CARRIAGE M10A1**



RA PD 61221

**Figure 133—Ammunition Stowage—Right Side**

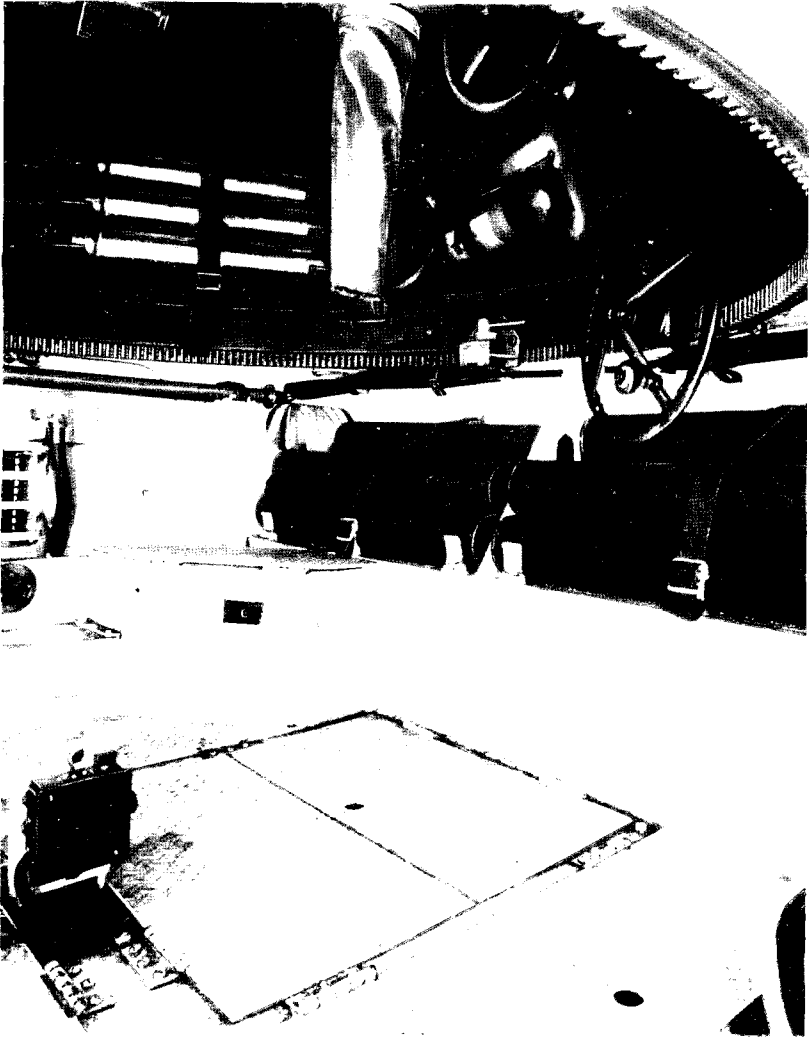
**AMMUNITION FOR RIFLE, U. S., CAL. .30, M1903  
(WITH LAUNCHER, GRENADE, M1)**

**SERVICE AMMUNITION**

- Cartridge, armor-piercing, cal. .30, M2.
- Cartridge, ball, cal. .30, M1.
- Cartridge, ball, cal. .30, M2.
- Cartridge, rifle grenade, cal. .30, M3.<sup>3</sup>
- Cartridge, tracer, cal. .30, M1.

<sup>3</sup>Special blank cartridge for use only in cal. .30 rifles for projecting grenades.

**AMMUNITION**



**Figure 134—Ammunition Stowage—Left Side**

RA PD 61222

**BLANK AMMUNITION**

Cartridge, blank, cal. .30, M1909.

**DUMMY AMMUNITION**

Cartridge, dummy, cal. .30, M1906 (corrugated).

**AMMUNITION FOR CARBINE, CAL. .30, M1**

**SERVICE AMMUNITION**

Cartridge, carbine, cal. .30, M1.

Cartridge, grenade, carbine, cal. .30, M6.<sup>4</sup>

<sup>4</sup>Special blank cartridge for use in the carbine for projecting grenades.

**3-INCH GUN MOTOR CARRIAGE M10A1**

**DUMMY AMMUNITION**

Cartridge, carbine, dummy, cal. .30, M1.

**GRENADES**

**SERVICE GRENADES**

Grenade, hand, fragmentation, Mk. II, with hand grenade igniting fuze, M10A2.

Grenade, hand, incendiary, AN-M14, with hand grenade igniting fuze, M200A1.<sup>5</sup>

Grenade, hand, smoke, white, AN-M8, with hand grenade igniting fuze, M200A1.<sup>5</sup>

Grenade, rifle, fragmentation, impact, M17.

Grenade, AT, M9A1.

Grenade, rifle, H. E., M9.

**PRACTICE AND TRAINING GRENADES, AND REPLACEABLE PARTS**

Grenade, hand, training, Mk. IA1.

Grenade, AT, practice, M11.

Grenade, AT, practice, M11A1.

Grenade, AT, practice, M11A2.

Fin, assembly, for practice rifle grenade, M11.

Fin, assembly, for AT practice grenade, M11A1.

Fin, assembly, for practice rifle grenade, M11A2.

Ogive, assembly, for practice rifle grenade, M11A2.

Adapter, grenade-projection, M1.<sup>6</sup>

**175. STOWAGE OF AMMUNITION.**

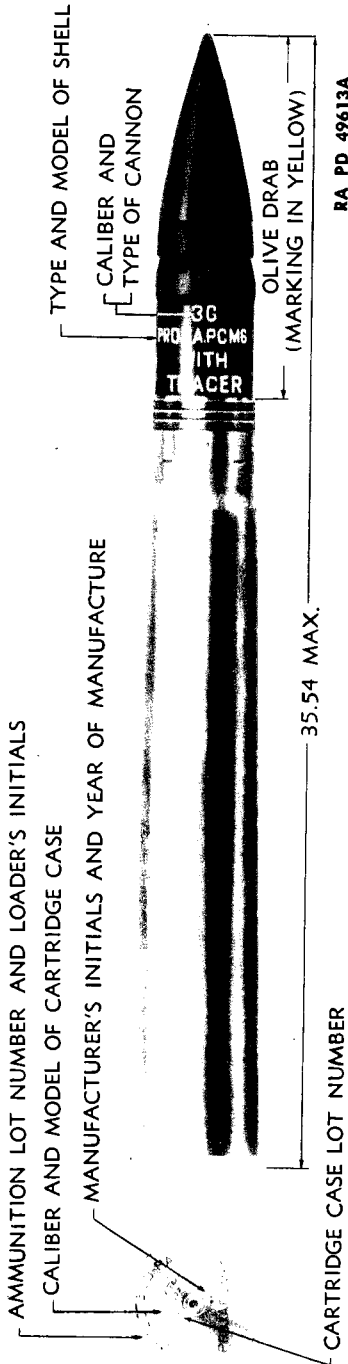
a. Provision for stowage of the ammunition in the carriage is indicated in Table II below and in figures 132 to 134, inclusive. The table has been prepared to serve as a guide only. It is without reference to any provision for mounting brackets or stowage boxes, which may be occasioned by special conditions in the field, or to ammunition which may be carried by means of a towed trailer.

---

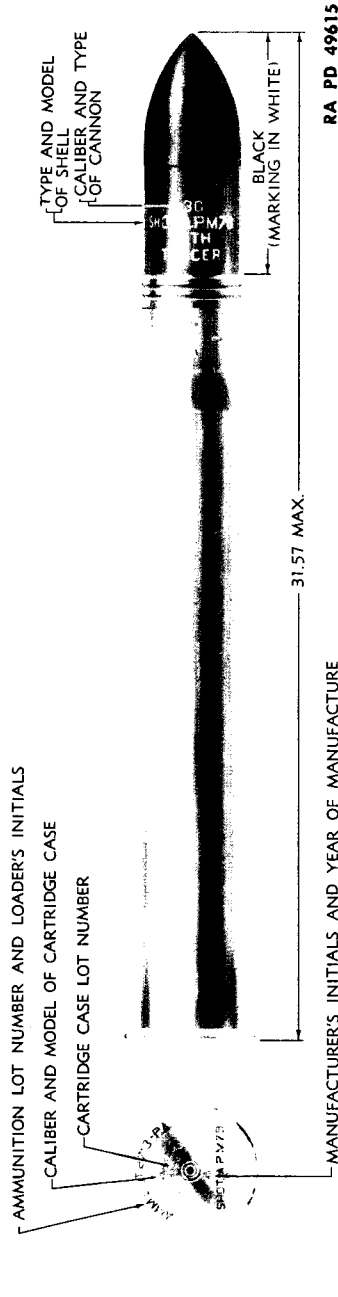
<sup>5</sup>Procurement from Chemical Warfare Service.

<sup>6</sup>For projecting Grenade, hand, fragmentation, Mk. II, with hand grenade igniting fuze, M10A2, from the rifle or carbine with appropriate launcher and special grenade cartridge. Used in conjunction with Clip, launcher positioning. Clips and special grenade cartridge issued and packed with adapters.

AMMUNITION

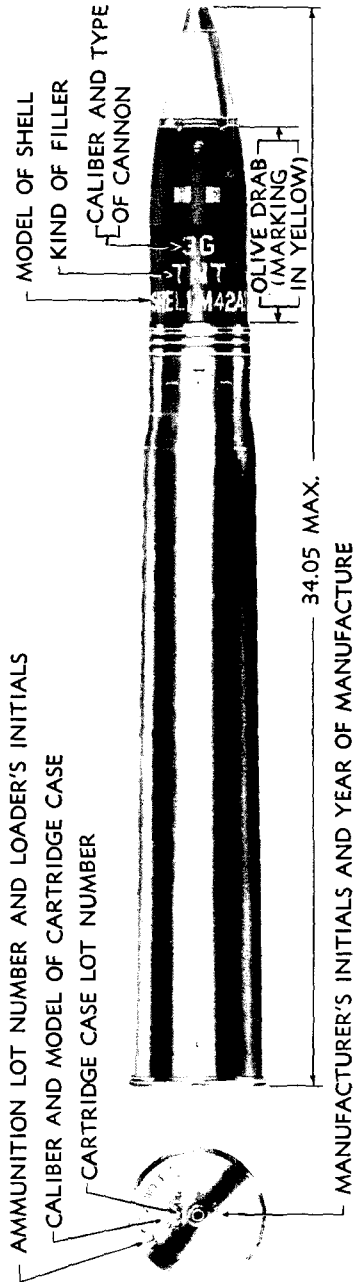


**Figure 135—PROJECTILE, fixed, A.P.C., M62, w/FUZE, B.D. M-66 or M66A1, and TRACER, 3-inch AA. Guns, M1918 (all models), M1, and M3, and 3-inch Guns, M5, M6, and M7**



**Figure 136—SHOT, fixed, A.P., M79, w/TRACER, 3-inch AA. Guns, M1918 (all models), M1, and M3, and 3-inch Guns, M5, M6, and M7**

3-INCH GUN MOTOR CARRIAGE M10A1



RA PD 49614A

Figure 137 — SHELL, fixed, H.E., M42A1, w/FUZE, P.D., M48A1 3-inch (15-pdr.) Gun, M1902M1 and 3-inch Guns, M5, M6, and M7

**AMMUNITION**

**TABLE II—AMMUNITION STOWAGE**

AMMUNITION	STOWAGE CAPACITY*	STOWAGE POSITION
3-inch rounds— 90 percent armor-piercing 10 percent high explosive	54 rounds	6 rounds without containers, in two 3-round brackets on rear turret wall. 48 rounds in fiber containers in four sponson compartments.
Caliber .50	300 rounds	In 50-round boxes in brackets under turret platform.
Caliber .45	460 rounds	440 rounds in 20-round clips in brackets on right rear turret wall. 20 rounds in clip on gun.
Caliber .30 rifle	60 rounds	In bandoleer on right front sponson plate near the assistant driver.
Caliber .30, carbine	**	On personnel to whom weapons are assigned.
Hand grenades	12 grenades	In two boxes on right turret wall just forward of caliber .45 ammunition bracket.
Antitank (rifle) grenades	10 grenades	**

\* Excludes provision for ammunition on towed trailer.

\*\* Data not available at time of printing.

**176. FIELD REPORTS OF ACCIDENTS.**

a. When an accident involving the use of ammunition occurs during training practice, the procedure prescribed in section VII, AR 750-10, will be observed by the ordnance officer under whose supervision the ammunition is maintained or issued. Where practicable, reports covering malfunctions of ammunition in combat will be made to the Chief of Ordnance, giving the type of malfunction, type of ammunition, the lot number of the complete rounds or separate loading components, and condition under which fired.



## 3-INCH GUN MOTOR CARRIAGE M10A1

## REFERENCES

## STANDARD NOMENCLATURE LISTS.

<b>Carriage, Motor, 3-inch gun, M10A1</b> .....	SNL G-170
<b>Ammunition.</b>	
Ammunition, blank, for pack, light and medium field artillery .....	SNL R-5
Ammunition, fixed and semifixed, all types, for pack, including subcaliber light and medium field artillery, including complete round data .....	SNL R-1
Ammunition instruction material for grenades, pyrotechnics and aircraft bombs .....	SNL S-6
Ammunition, revolver, automatic pistol, and sub-machine gun .....	SNL T-2
Ammunition, rifle, carbine, and automatic gun .....	SNL T-1
Grenades, hand and rifle, and fuzing components .....	SNL S-4
Packing materials used by field service for small arms service ammunition .....	SNL T-5
Service fuzes and primers for pack, light and medium field artillery .....	SNL R-3
<b>Armament.</b>	
Carbine, cal. .30, M1 and M1A1—Parts and equipment .....	SNL B-28
Gun, 3-in., M7; and mount, gun, 3-in., M5 .....	SNL C-43
Gun, machine, cal. .50, Browning, M2, heavy barrel, fixed and flexible; and ground mounts—Parts and equipment .....	SNL A-39
Gun, submachine, cal. .45, Thompson, M1928A1, M1, and M1A1—Parts and equipment .....	SNL A-32
Launcher, grenade, M1 and M2—Parts and equipment .....	SNL B-39
Major items of Group A .....	SNL A-1
Major items of Group B .....	SNL B-1
Major items of pack, light and medium field artillery; and armament of these calibers for airplane and combat vehicles .....	SNL C-1
Rifle, U. S., cal. .30, M1903, M1903A1, and M1903A3—Parts and equipment .....	SNL B-3
<b>Sighting Equipment.</b>	
<b>Firing tables and trajectory charts</b> .....	SNL F-69
Periscopes, telescopes for periscopes, and direct sighting telescopes for use in tanks .....	SNL F-235
Quadrant, gunner's, M1 (mils) .....	SNL F-140
Telescope, panoramic, M12, series .....	SNL F-214

**REFERENCES**

**Maintenance.**

- Cleaning, preserving and lubricating materials; recoil fluids, special oils, and miscellaneous related items. SNL K-1
- Soldering, brazing and welding material, gases and related items . . . . . SNL K-2
- Tools, maintenance, for repair of automatic guns, automatic gun antiaircraft materiel, automatic and semi-automatic cannon and mortars—Individual items and parts . . . . . SNL A-35
- Tools, maintenance, for repair of pack, light and medium field artillery; and armament of these calibers of airplane and combat vehicles. . . . . SNL C-18
- Current Standard Nomenclature Lists are as tabulated here. An up-to-date list of SNL's is maintained as the "Ordnance Publications for Supply Index" . . . . . OPSI

**EXPLANATORY PUBLICATIONS.**

**Armament.**

- 3-inch Tank Gun Materiel M7 . . . . . TM 9-323
- Ammunition, general . . . . . TM 9-1900
- Ammunition, general . . . . . OFSB 3-1
- Automatic pistol, cal. .45, M1911 and M1911A1 . . . . . FM 23-35
- Auxiliary fire-control instruments (field glasses, eyeglasses, telescopes, and watches) . . . . . TM 9-575
- Browning machine gun, cal. .50, HB, M2 (mounted in combat vehicles) . . . . . FM 23-65
- Field artillery and field motor ammunition . . . . . OFSB 3-3
- Grenades . . . . . FM 23-30
- Instruction guide, small arms data . . . . . TM 9-2200
- Ordnance service in the field . . . . . FM 9-5
- Qualifications in arms and ammunition training allowances . . . . . AR 775-10
- Range regulations for firing ammunition for training and target practice . . . . . AR 750-10
- Small arms ammunition . . . . . TM 9-1990
- Small arms ammunition . . . . . OFSB 3-5
- Targets, target materials, and rifle range construction. . . . . TM 9-855
- Thompson submachine gun, cal. .45, M1928A1 . . . . . FM 23-40
- U. S. Carbine, cal. .30, M1 . . . . . FM 23-7
- U. S. Rifle, cal. .30, M1903 . . . . . FM 23-10

**Chemical Warfare.**

- Chemical decontamination materials and equipment . . . . . TM 3-220
- Defense against chemical attack . . . . . FM 21-40
- Decontamination of armored force vehicles . . . . . FM 17-59

**3-INCH GUN MOTOR CARRIAGE M10A1**

<b>Communications.</b>	
Radio fundamentals .....	TM 11-455
Radio operator, the .....	TM 11-454
Radio set, SCR 610 .....	TM 11-615
<b>Maintenance and Inspection.</b>	
Automotive electricity .....	TM 10-580
Automotive lubrication .....	TM 10-540
Cleaning, preserving, lubricating, and welding materials and similar items issued by the Ordnance Department .....	TM 9-850
Echelon system of maintenance .....	TM 10-525
Fire prevention, safety precautions, accidents .....	TM 10-360
Motor transport inspections .....	TM 10-545
Sheet metal work, body, fender and radiator repairs .....	TM 10-450
Tune-up and adjustment .....	TM 10-530
<b>Ordnance Maintenance.</b>	
Accessories for Ford tank engine, model GAA V-8 .....	TM 9-1731C
Auxiliary generator (Homelite HRUH-28) .....	TM 9-1731K
Ford tank engine, model GAA V-8 .....	TM 9-1731B
Hull and turret, hull and turret electrical system, tracks and suspension .....	TM 9-1750L
Power train (one piece differential) .....	TM 9-1750B
<b>Camouflage.</b>	
Camouflage .....	FM 5-20
Camouflage painting of vehicles and equipment .....	FM 5-21
<b>Electric fundamentals</b> .....	TM 1-455
<b>Fuels and carburetion</b> .....	TM 10-550
<b>Index of technical and administrative publications for the ordnanceman</b> .....	OFSB 1-1
<b>List of publications for training, including training films and film strips</b> .....	FM 21-6
<b>Military motor transportation</b> .....	TM 10-505
<b>Military motor vehicles</b> .....	AR 850-15
<b>Motor transport</b> .....	FM 25-10

INDEX

<b>A</b>	<b>Page No.</b>	<b>B</b>	<b>Page No.</b>
Accessories and equipment.....	50-51	Barrel assembly, description and functioning	
Accessory drive shaft housing, lubrication .....	44	breech ring .....	215-217
Accessory drive shafts, description	171	breech ring key .....	217
Accessory drives		tube .....	215
description .....	129	Batteries	
replacement .....	130	description .....	140
Adjustments:		maintenance and inspection.....	142
clutch pedal rod .....	163	second echelon preventive services .....	73
hand throttle .....	119	Battery cables, description and replacement .....	142
parking brakes .....	187	Battery master switch	
steering brakes .....	180-183	description .....	153
track tension .....	196-197	location and functioning .....	21-22
throttle controls .....	119	removal .....	153
Air cleaners		Blackout driving light switch	
after-operation and weekly service .....	38	description .....	13, 149
at-halt service .....	36	removal .....	149
description and maintenance.....	117	Blackout headlight	
installation .....	97	description .....	154
lubrication .....	43	inspection .....	189
removal .....	95	installation .....	192
replacement .....	117-119	removal .....	191
second echelon preventive maintenance services .....	70	Bogies	
Ammeter		description and lubrication.....	190
before-operation service .....	33	replacement	
description .....	12, 148	bogie wheel .....	191-192
during-operation service .....	35	bogie wheel grease seal and bearing .....	192-193
second echelon preventive maintenance services .....	66	track support roller and bracket .....	194-195
Ammunition		volute spring .....	193-194
authorized .....	263-268	second echelon preventive maintenance services .....	69
data .....	212	Bracket and lever controls, maintenance duties by echelons.....	55
field report of accidents.....	271	Brakes, second echelon preventive maintenance services .....	66-67
stowage .....	268-271	Breather cap, after-operation and weekly service .....	38
Ammunition boxes and racks, maintenance duties by echelons.	55	Breech mechanism	
Antifreeze .....	124	description and functioning	
Armament		breech operating shaft.....	222
accessories .....	47-48	breechblock .....	218-220
ammunition .....	49-50	breechblock operating crank .....	222-223
characteristics .....	209-211	chain terminal crank.....	223-224
data .....	211-213	extractor plungers .....	221-222
guns .....	50	extractors .....	220-221
spare parts .....	48-49		
tools .....	49		
Armor thickness, data.....	8		
Authorized ammunition .....	263-268		

3-INCH GUN MOTOR CARRIAGE M10A1

<b>B—Cont'd</b>	<b>Page No.</b>	<b>Page No.</b>
Breech mechanism—Cont'd		
description and functioning—Cont'd		
firing plunger . . . . .	224	
operating crank . . . . .	223	
function and operation . . . . .	229–236	
lubrication . . . . .	45, 257	
Breech operating shaft, description and functioning . . . . .	222	
Breech ring, description and functioning . . . . .	215–217	
Breechblock, description and functioning . . . . .	218–220	
Breechblock operating crank, description and functioning . . . . .	222–223	
<b>C</b>		
Cam ejector mechanism, description and functioning . . . . .	244–248	
Carburetor adapters		
description . . . . .	116	
replacement . . . . .	116–117	
Carburetors		
description . . . . .	113	
idler fuel adjustment . . . . .	113	
idler speed adjustment . . . . .	113–115	
removal and installation . . . . .	116	
Carriage, gun, motor, 3-inch, M10A1		
data . . . . .	5–11	
description . . . . .	5	
Center drive plate travel limit, adjustment . . . . .	164–165, 170	
Chain terminal crank, description and functioning . . . . .	223–224	
Characteristics of armament . . . . .	209–211	
Circuit breakers		
description . . . . .	145	
operation . . . . .	12	
replacement . . . . .	139, 145–148	
Cleaning		
fuel filter . . . . .	121	
oil filter . . . . .	102	
Closing spring mechanism		
construction . . . . .	224–225	
function . . . . .	225	
Clutch		
clutch drag . . . . .	163–165	
description . . . . .	163	
during-operation service . . . . .	34	
replacement . . . . .	166–170	
Clutch pedal, description . . . . .	21	
Clutch pilot bearing, lubrication . . . . .	44	
Clutch pressure plate, installation . . . . .	168	
Compartment light, description . . . . .	156	
Conduits and wires		
description and maintenance . . . . .	157	
replacement . . . . .	157–158	
Controlled differential and sub-assembly, maintenance duties by echelons . . . . .	56	
Cooling system		
accessory drives . . . . .	129–130	
antifreeze . . . . .	124	
corrosion inhibitor . . . . .	125	
description and maintenance . . . . .	124	
draining . . . . .	93	
expansion tank and filler . . . . .	131	
fans . . . . .	128–129	
filling . . . . .	98	
maintenance duties by echelons . . . . .	55	
radiator . . . . .	125–127	
thermostat . . . . .	130	
water pump . . . . .	127–128	
Corrosion inhibitor, description . . . . .	125	
Cradle, description and functioning . . . . .	237–239	
Crankcase, lubrication . . . . .	43	
Crankcase breather		
description . . . . .	102	
servicing filter element . . . . .	103	
Current limiter, description . . . . .	140	
Cylinder heads and gaskets, second echelon preventive maintenance services . . . . .	70	
<b>D</b>		
Data		
armament . . . . .	211–213	
carriage . . . . .	5–11	
engine . . . . .	82–84	
Dead track block		
definition . . . . .	197	
installation . . . . .	199	
removal . . . . .	197–198	
Decontaminator, second echelon preventive services . . . . .	76	
Degassers, description and replacement . . . . .	116	
Description (See also Description and functioning)		
accessory drives . . . . .	129	
air cleaners . . . . .	117	
ammeter . . . . .	148	
battery . . . . .	140	

INDEX

D—Cont'd	Page No.	Page No.	
Description—Cont'd			
bogies .....	190	tachometer .....	161
carburetor adapters .....	116	taillights .....	154-155
carburetors .....	113	thermostat .....	130
circuit breaker .....	138-139, 145	tracks .....	195-196
clutch .....	163	transmission .....	176
conduits and wires .....	157	transmission oil cooler .....	178-179
cooling system .....	124	transmission oil temperature	
degassers .....	116	gage .....	150
differential .....	177-178	turret compass .....	162
drive sprockets .....	189	universal joints .....	170-171
electrical system and equip-		utility outlet sockets .....	148
ment .....	133-135	valve mechanism .....	100
engine .....	82-84	voltmeter .....	149
engine boil signal .....	151	water pump .....	127
engine temperature gage .....	152	Description and functioning	
expansion tank and filler .....	131	gun	
fans .....	128	barrel assembly .....	215-217
final drive .....	178	breech mechanism .....	217-224
foot throttle .....	119	closing spring mechanism .....	224-225
fuel filter .....	120-121	function and operation of	
fuel level gage .....	152	breech mechanism .....	229-236
fuel pump .....	120	percussion and cocking	
fuel shut-off switch .....	148	mechanism .....	225-229
fuel system .....	113	mount	
gearshift lever .....	22-23	cam ejector mechanism .....	244-248
generating system .....	135	cradle .....	237-239
generator circuit breaker .....	138-139	electrical firing circuit .....	244
generator filter .....	140	elevating mechanism .....	239
generator regulator .....	139-140	gun recoil guard assembly .....	240-242
generators .....	138	mechanical firing mecha-	
governor .....	100	nism .....	242-244
gun motor carriage .....	5	recoil mechanism .....	240
hand throttle .....	119	Differential	
hull .....	204	description .....	177-178
idlers .....	202	second echelon preventive main-	
ignition system .....	104	tenance services .....	68
instrument panel .....	145	Drive sprockets	
low oil pressure signal .....	151	description .....	189
oil filter .....	101	replacement .....	190
oil level gage .....	150		
parking brake .....	184	<b>E</b>	
power train .....	173	Electrical firing circuit, description	
priming pump .....	120	and functioning .....	244
propeller shaft .....	170	Electrical system and equipment	
radiator .....	125-126	ammeter .....	148
speedometer .....	160	battery .....	140-142
starter .....	142-143	battery master switch .....	153
starter solenoid .....	143-145	blackout driving light switch .....	149
starting system .....	142	circuit breakers .....	145-148
stop light switch .....	155	compartment light .....	156
suspensions and tracks .....	188	conduits and wires .....	157-158
		description .....	133-135

3-INCH GUN MOTOR CARRIAGE M10A1

E—Cont'd	Page No.	Page No.	
Electrical system and equipment—			
Cont'd			
engine boil signal	151	testing	25
engine temperature gage	152	trouble shooting	84-92
fire detector signal	149-150	valve mechanism	100
fuel cut-off switch	148	Engine boil signal, description and replacement	151
fuel level gage	152	Engine compartment lower plate, removal	93
fuel level gage selector switch	152	Engine floor plate installation	98-99
generating system	135-138	Engine oil level gage	
generator circuit breaker	138-139	before-operation service	33
generator filter	140	during-operation service	35
generator regulator	139-140	Engine temperature gage	
generators	138	before-operation service	33
headlights	153-154	description and replacement	152
ignition switch	148-149	during-operation service	35
inspection light	156	location and functioning	17-18
instrument panel	145	second echelon preventive maintenance services	66
instrument panel lights	150	Equipment and tools on vehicle	
light switch	149	armament	47-50
low oil pressure signal	151	miscellaneous accessories and tools	50-51
maintenance duties by		sighting equipment	50
echelons	57-58	signaling equipment	51
oil level gage	150-151	vehicular tools and spare parts	52-53
panel light rheostat switch	153	Escape hatch, description	205
radio master switch	153	Exhaust manifold	
siren	157	description	100
starter	142-143	replacement	100-101
starter button	149	Expansion tank and filler, description	131
starter solenoid	143-145	Extractor plungers, description and functioning	221-222
starting system	142	Extractors, description and functioning	220-221
stop light switch	155		
taillights	154-155	<b>F</b>	
transmission oil temperature		Fan and shroud assemblies	
gage	150	installation	98
trouble shooting	158-159	removal	95
utility outlet sockets	148	replacement	128
voltmeter	149	Fan belts	
wiring	159	adjustment	128
Elevating mechanism		installation	98
description and functioning	239	removal	94-95
operation	250-251	Field report of ammunition accidents	271
Engine		Final drive	
crankcase breather	102-103	description and replacement	178
description and data	82-84	maintenance duties by echelons	56
governor	100	second echelon preventive maintenance services	68
maintenance duties by			
echelons	58-60		
manifold	100-101		
mounts	99		
oil filter	101-102		
oil pump	101		
replacement	93-99		

INDEX

<b>F—Cont'd</b>	<b>Page No.</b>	<b>Page No.</b>
Final reduction, maintenance duties by echelons . . . . .	56	degassers . . . . . 116
Fire detector signal		description and trouble shooting 113
description . . . . .	149-150	fuel filter . . . . . 120-122
during-operation service . . . . .	35	fuel pump . . . . . 120
replacement . . . . .	149-150	fuel tanks . . . . . 122-123
Fire extinguisher		maintenance duties by echelons 60
after-operation and weekly service . . . . .	38	priming pump . . . . . 120
before-operation service . . . . .	34	throttle controls . . . . . 119-120
fixed extinguishers . . . . .	23-24	Fuel tanks
lubrication . . . . .	45	draining . . . . . 122
maintenance duties by echelons 60		location and capacity . . . . . 122
portable extinguishers . . . . .	23	replacement . . . . . 122-123
second echelon preventive maintenance services . . . . .	72	Functioning (See Description and functioning)
Fire extinguisher system		<b>G</b>
handling . . . . .	208	Gear case, lubrication . . . . . 43-44
maintenance and replacement . . . . .	206-208	Gearshift lever
operation . . . . .	206	description . . . . . 22-23
Firing mechanism, lubrication . . . . .	257	operation . . . . . 23
Firing plunger, description and functioning . . . . .	224	Generating system
Firing solenoid circuit breaker, description and functioning . . . . .	22	description . . . . . 135
Fittings and oilers, lubrication . . . . .	257	trouble shooting . . . . . 135-138
Foot throttle		Generator and fan drive assembly, maintenance duties by echelons . 56
description . . . . .	119	Generator circuit breaker
replacement . . . . .	120	description . . . . . 138-139
Fuel and oil capacities . . . . .	11	replacement . . . . . 139
Fuel cut-off switch, description and replacement . . . . .	148	Generator filter, description and replacement . . . . . 140
Fuel filter		Generator regulator
cleaning . . . . .	121	description . . . . . 139-140
description . . . . .	120-121	inspection and adjustment . . . . . 140
lubrication . . . . .	44	second echelon preventive maintenance services . . . . . 73
replacement . . . . .	121-122	Generators, description and maintenance . . . . . 138
second echelon preventive maintenance services . . . . .	72	Governor, description . . . . . 100
Fuel level gage, description and replacement . . . . .	152	Governor control, description . . . . . 120
Fuel level gage selector switch		Ground circuit, description . . . . . 135
description . . . . .	152	Grousers, installation . . . . . 203
location and functioning . . . . .	18	Gun
Fuel pump, description and replacement . . . . .	120	data . . . . . 211-212
Fuel shut-off valve, location . . . . .	21	lubrication . . . . . 256-258
Fuel system		operation . . . . . 249-255
air cleaners . . . . .	117-119	Gun bore, lubrication . . . . . 45
carburetor adapters . . . . .	116-117	Gun elevating mechanism, second echelon preventive maintenance services . . . . . 67
carburetors . . . . .	113-116	Gun recoil guard assembly, description and functioning . . . . . 240-242



3-INCH GUN MOTOR CARRIAGE M10A1

H	Page No.
Hand throttle, description and functioning .....	18, 119
Headlights	
blackout .....	154
service .....	153-154
Hull and turret	
escape hatch .....	205
hull .....	204
maintenance duties by echelons .....	60-61
turret .....	204-205
vision and sighting equipment .....	205

I	
Idlers	
description and lubrication .....	202
idler bracket replacement .....	203
idler wheel replacement .....	202
Ignition system	
description .....	104
ignition switch .....	110-111
ignition timing and magneto governor advance .....	107-110
magnetos .....	106-107
spark plug wires and conduits .....	112
Inspection	
battery .....	142
carriage .....	24
generator regulator .....	140
generators .....	138
suspension and tracks .....	188-189
Inspection light, description .....	156
Instrument panel, description and removal .....	145
Instrument panel lights, replacement .....	150
Instruments and controls	
controls .....	18-24
instrument panel .....	12-18
Instruments and gages, second echelon preventive maintenance services .....	66
Intake manifold, description .....	100
Intervals of lubrication .....	40, 257-258

L	
Light switch, description and removal .....	149
Limitations of the vehicle .....	11
Link adjustment .....	100
Loading the gun .....	252

	Page No.
Low oil pressure signal description and replacement .....	151
functioning .....	17
Lubrication	
bogies .....	190
carriage .....	40-46
final drive .....	178
gun and mount lubrication guide .....	256-257
points to be lubricated by ordnance personnel .....	257
reports and records .....	258
special lubrication and service instructions .....	257-258
idlers .....	202
power train .....	173
Lubrication guide .....	40-46

M	
Magneto	
data .....	84
description .....	104
installation when timing has been lost .....	105-106
replacement .....	104-105
resetting breaker points .....	106-107
Maintenance	
air cleaners .....	117
battery .....	142
conduits and wires .....	157
cooling system .....	124
fire extinguisher system .....	206
generators .....	138
Manifolds	
exhaust .....	100-101
intake .....	100
water .....	101
Mechanical firing mechanism, description and functioning .....	242-244
Mount	
data .....	213
description .....	99
lubrication .....	256-258
Muzzle velocity .....	211

N	
Nonelectrical instruments	
clock .....	160
speedometer .....	160-161
tachometer .....	161
turret compass .....	162

INDEX

O	Page No.	Page No.
Oil filler pipe		
installation	98	prestating inspection
removal	94	starting instructions
Oil filter		stopping the engine
description	101	towing instructions
lubrication	43	Organization preventive maintenance services by second echelon
operation check	101-102	
replacement and cleaning	102	Organizational tools and equipment, list of
second echelon preventive maintenance services	68	
Oil level gage		<b>P</b>
description	150	Panel light rheostat switch
replacement	150-151	description
Oil pressure gage		location and functioning
before-operation service	33	Parking brake
during-operation service	35	adjustment
location and functioning	17	description
second echelon preventive maintenance services	66	replacement
Oil pump, description	101	Percussion and cocking mechanism, description and functioning
Oil transmission cooler, maintenance duties by echelons	61	Periscope M6, description and functioning
Oilcan points	45-46	Placing gun in traveling position
Operating crank, description and functioning	223	Power train
Operation (See also Operation and controls)		differential
breech mechanism	229-236	final drive
carriage	25-27	parking brake
fire extinguisher system	206	power train unit
gearshift lever	23	steering brakes
gun		transmission
elevating mechanism	250-251	transmission oil cooler
firing and precautions during firing	252-253	Precautions during firing
loading	252	Prestating inspection (See Inspection)
placing in firing position	249-250	Preventive maintenance inspection and services
placing in traveling position	254-255	after-operation and weekly service
traversing mechanism	250	at-halt service
unloading	253	before-operation service
under unusual conditions		during-operation service
cold weather starting	29	purpose
high altitudes	30	Priming pump
high temperatures	29-30	description and functioning
sand, slippery terrain, and dusty conditions	30	replacement
Operation and controls		Propeller shaft
engine test	25	description and replacement
information on instruments and controls	12-24	maintenance duties by echelons
operating the vehicle	25-27	Propeller shaft universal joints
		description
		removal and installation

3-INCH GUN MOTOR CARRIAGE M10A1

<b>Q</b>	<b>Page No.</b>	<b>Page No.</b>
Quadrant, gunner's, M1, elevation and depression angles . . . . .	262	Starting system, description and trouble shooting . . . . . 142
<b>R</b>		Steering brakes
Radiator		adjustment . . . . . 180-183
description . . . . . 125-126		during-operation service . . . . . 34
replacement . . . . . 126-127		replacement of shoes . . . . . 183-184
second echelon preventive maintenance services . . . . . 73		Stop light switch, description . . . . . 155
Radio master switch, description . . . . . 153		Stowage of ammunition . . . . . 268-271
Rebuild and repair defined . . . . . 55		Support rollers, inspection . . . . . 189
Recoil mechanism, description and functioning . . . . . 240		Suspensions and tracks
Replace defined . . . . . 55		bogies . . . . . 190-195
Reports and records of lubrication . . . . . 46, 258		description . . . . . 188
Reversing track . . . . . 201-202		drive sprockets . . . . . 189-190
		idlers . . . . . 202-203
		inspection . . . . . 188-189
		installation of grouzers . . . . . 203
		tracks . . . . . 195-202
<b>S</b>		<b>T</b>
Service defined . . . . . 54		Tachometer
Service headlight, description . . . . . 153		before-operation service . . . . . 33
Sighting equipment		description and replacement . . . . . 13-16, 161
data . . . . . 50		during-operation service . . . . . 35
gunner's quadrant M1 . . . . . 262		second echelon preventive maintenance services . . . . . 66
periscope M6 . . . . . 262		Taillights, description . . . . . 154-155
telescope M51 . . . . . 259		Telescope M51, description and functioning . . . . . 259
Signaling equipment, data . . . . . 51		Testing:
Slippery terrain, operation of vehicle on . . . . . 30		fuel pump . . . . . 120
Spark plug wires and conduits, replacement . . . . . 112		steering levers . . . . . 182-183
Specific gravity tests of battery . . . . . 142		Thermostat, description and replacement . . . . . 130
Speedometer		Throttle controls
description . . . . . 160		adjustment . . . . . 119
during-operation service . . . . . 35		foot throttle . . . . . 119-120
replacement . . . . . 160-161		governor control . . . . . 120
second echelon preventive maintenance services . . . . . 66		hand throttle . . . . . 119
Springs and suspensions		Thrown track, replacement . . . . . 200-201
after-operation and weekly service . . . . . 38		Towing instructions . . . . . 27-28
before-operation service . . . . . 34		Track support roller and bracket, replacement . . . . . 194-195
Stabilizer mechanism, second echelon preventive maintenance services . . . . . 67		Tracks
Starter		adjustment of tension . . . . . 196-197
description . . . . . 142-143		dead track block replacement . . . . . 197-199
replacement . . . . . 143		description . . . . . 195-196
Starter button, description . . . . . 149		reversing track . . . . . 201-202
Starter solenoid		second echelon preventive maintenance services . . . . . 68
description . . . . . 143-145		thrown track replacement . . . . . 200-201
replacement . . . . . 145		

INDEX

<b>T—Cont'd</b>	<b>Page No.</b>	<b>U</b>	<b>Page No.</b>
Transmission		Universal joints, lubrication . . . . .	45
description . . . . .	176	Unloading the gun . . . . .	253
maintenance duties by echelons	56	Utility outlet socket, description	
replacement . . . . .	177	and replacement . . . . .	148
Transmission oil cooler			
description . . . . .	178-179		
replacement . . . . .	179		
second echelon preventive main-			
tenance services . . . . .	74		
Transmission oil temperature gage			
before-operation services . . . . .	33		
description and replacement . . . . .	150		
during-operation service . . . . .	35		
functioning . . . . .	17		
second echelon preventive main-			
tenance services . . . . .	66		
Traversing mechanism			
operation . . . . .	250		
second echelon preventive main-			
tenance services . . . . .	67		
Traversing rack and pinion,			
lubrication . . . . .	257		
Trouble shooting			
electrical system and equip-			
ment . . . . .	158-159		
engine . . . . .	84-92		
fuel system . . . . .	113		
generating system . . . . .	135-138		
ignition system . . . . .	104		
starting system . . . . .	142		
Turret			
data . . . . .	8		
description . . . . .	204		
second echelon preventive main-			
tenance services . . . . .	74		
(See also Hull and turret)			
Turret compass, description . . . . .	162		

**V**

Valve mechanism, description . . . . .	100
Vehicular tools and spare parts	
pioneer tools . . . . .	53
spare parts . . . . .	52
Vision and sighting equipment,	
description . . . . .	205
Voltmeter	
description . . . . .	13, 149
during-operation service . . . . .	35
removal . . . . .	149
second echelon preventive main-	
tenance services . . . . .	66
Volute spring	
installation . . . . .	194
removal . . . . .	193-194

**W**

Water manifolds, description and	
replacement . . . . .	101
Water pump (and radiator expan-	
sion tank)	
description . . . . .	127
installation . . . . .	98
lubrication and replacement . . . . .	128
removal . . . . .	94

[ A.G. 300.7 (9 Jun 1943)  
O.O.M. 461/344 Misc. R. (14 Aug 1943) ]

BY ORDER OF THE SECRETARY OF WAR:

OFFICIAL:

J. A. ULIO,  
*Major General,  
The Adjutant General.*

G. C. MARSHALL,  
*Chief of Staff.*

DISTRIBUTION: R.9(4); Bn 9 and 18(2); C 9(8); IC 18(10)  
(For explanation of symbols, see FM 21-6)